

Master of Excellence

EXTETA





Master of Excellence

EXTETA

EN Living without boundaries translates into a vision of living where the open-air world becomes an inexhaustible source of inspiration, sensoriality, and sharing. An open horizon that invites freedom, discovery, and the authentic pleasure of experiencing every space with intensity. Exteta has transformed this ideal into an art form, redefining outdoor living as an immersive and profound experience, in continuous dialogue with the landscape — whether natural or architectural — generating a fluid balance between interiority and horizon. An aesthetic of living that transcends physical boundaries and expresses itself through atmospheres, materials, and suggestions capable of creating authentic and lasting connections. Exteta's creations give form to this philosophy: pure expressions of stylistic elegance, material research, and artisanal savoir-faire, interpreted through a tailor-made design that adapts naturally to every setting. At the heart of each collection lies a meticulous selection of the finest materials, to ensure strength and durability over time. The finishes — evocative of ancient techniques, still applied by hand — give uniqueness to every piece, while constant experimentation with forms brings character and elevates aesthetic allure to new heights of refinement. Thus are born furnishing scenographies that speak the language of excellence, in terms of performance, quality, and style. A universe where each creation carries the distinctive mark of Exteta's haute couture. True to this identity, the company has given life to a distinctive outdoor lifestyle capable of reflecting the charm of the indoor. Anticipating the trends of contemporary design, Exteta has dissolved the boundary between interior and exterior, creating a single, coherent, harmonious, and continuous dimension. Spaces merge in aesthetic harmony, through compositions that mirror styles, materials, and design languages, in perfect balance between functionality and absolute comfort. It is a celebration of the full pleasure of living: the softness of the padding, the authentic tactility of natural surfaces, the enveloping sensation of hospitality designed in every detail. A design story that exalts conviviality and the art of living with an exclusive, essential, and profoundly elegant style.

IT Il vivere senza confini si traduce in una visione dell'abitare in cui il mondo en plein air diventa fonte inesauribile di ispirazione, sensorialità e condivisione. Un orizzonte aperto che invita alla libertà, alla scoperta, al piacere autentico di vivere ogni spazio con intensità. Exteta ha trasformato questo ideale in una forma d'arte, ridefinendo l'outdoor living come un'esperienza immersiva e profonda, in continuo dialogo con il paesaggio — naturale o architettonico — generando un equilibrio fluido tra interiorità e orizzonte. Un'estetica del vivere che trascende i confini fisici e si esprime attraverso atmosfere, materiali e suggestioni capaci di creare connessioni autentiche e durature. Le creazioni Exteta danno forma a questa filosofia: espressioni pure di eleganza stilistica, ricerca materica e savoir-faire artigianale, interpretate da un design tailor made che si adatta con naturalezza a ogni scenario. Alla base di ogni collezione vi è un'approfondita selezione dei materiali più nobili, per garantire resistenza e durata nel tempo. Le finiture — evocative di tecniche antiche, applicate ancora a mano — conferiscono unicità ad ogni pezzo, mentre la costante sperimentazione sulle forme dà carattere ed eleva l'allure estetica a nuovi livelli di raffinatezza. Nascono così scenografie d'arredo che parlano il linguaggio dell'eccellenza, in termini di performance, qualità, stile. Un universo in cui ogni creazione porta con sé il segno distintivo dell'haute couture di Exteta. Fedele a questa identità, l'azienda ha dato vita a un distintivo outdoor lifestyle capace di riflettere il fascino dell'indoor. Anticipando le tendenze del design contemporaneo, Exteta ha dissolto il confine tra interno ed esterno creando un'unica dimensione coerente, armoniosa, continua. Gli spazi si fondono in una sintonia estetica fatta di composizioni che replicano stile, materiali e linguaggi progettuali, in perfetto equilibrio tra funzionalità e comfort assoluto. Si celebra il piacere di vivere a tutto tondo: la morbidezza delle imbottiture, la tattilità autentica delle superfici naturali, la sensazione avvolgente di un'accoglienza pensata nei minimi dettagli. Un racconto di design che esalta la convivialità e l'arte dell'abitare con uno stile esclusivo, essenziale e profondamente elegante.

INTRO	5
Boundless Creativity	8
The Wisdom of Hands	14
COLLABORATIONS	19
Exteta x Riva	20
Loro Piana Interiors, The Delight Chairs by Exteta	26
Jacquemus + Exteta, special re-edition of Locus Solus 1964.....	32
BREATHE THE OUTDOORS	39
Chapter I, The Charm of the Essential	40
Chapter II, Immersed in Nature	78
Chapter III, Between Sky and City	114
DESIGNERS	145
Franco Albini.....	146
Gae Aulenti	147
Massimo Castagna	148
Paola Navone OTTO Studio	149
Ludovica + Roberto Palomba	150
Studiopepe	151
Marco Zanuso	152
PRODUCTS	155
MATERIALS	307
Products Index	316

BOUNDLESS CREATIVITY

EN Exteta's 2025 collection is the perfect representation of its philosophy, constantly balancing elegance and performance. With its distinctive artisanal savoir-faire and boundless creativity, the company expresses its vision of outdoor living through new designs, expanded collections, and exclusive collaborations. The artistic direction of Arianna Lelli Mami and Chiara Di Pinto, founders of Studiopepe, sensitively and coherently orchestrates every element, bringing together different poetics into a harmonious vision.

"Attention to detail, technical research, and formal study are the foundation of every product and represent Exteta's signature," says Studiopepe. "Every detail speaks of love and passion, and we share this attitude in our work as designers and architects."

Among the key names in the new collection are Massimo Castagna and Paola Navone OTTO Studio, with projects that best embody the brand's free and sophisticated spirit. Highlights include two prestigious collaborations: Loro Piana Interiors, The Delight Chairs by Exteta, now enriched with new proposals, and the brand-new Exteta x Riva, where the brand's passion for the nautical world merges with Riva's exclusive heritage and its iconic boats. Exteta's new creations emerge from diverse inspirations, yet engage in dialogue with one another in perfect balance – a harmony of forms, functions, and impressions.

Scenic compositions meet and blend effortlessly, united by a recognizable aesthetic and a language shaped by style, intent, and personality. Once again, the lines are fluid, organic, inspired by nature, and designed to accompany everyday life.

IT La collezione 2025 di Exteta è la perfetta rappresentazione della sua filosofia, costantemente in equilibrio fra eleganza e performance. Con il suo distintivo savoir-faire artigianale e una creatività senza confini, l'azienda racconta la sua visione dell'outdoor living attraverso nuove proposte, ampliamenti di collezione e collaborazioni esclusive. La direzione artistica di Arianna Lelli Mami e Chiara Di Pinto, fondatrici di Studiopepe, orchestra con sensibilità e coerenza ogni elemento, unendo poetiche differenti in una visione armonica. «L'attenzione al dettaglio, la ricerca tecnica, lo studio formale sono alla base di ogni prodotto e sono il tratto distintivo di Exteta. Ogni dettaglio parla di amore e passione e condividiamo questa attitudine nel nostro lavoro di designer e architetti», dichiara Studiopepe.

Tra i protagonisti della nuova collezione spiccano i nomi di Massimo Castagna e Paola Navone OTTO Studio, con progetti che esprimono al meglio l'anima libera e sofisticata del brand. Tra le novità spiccano due prestigiose collaborazioni: Loro Piana Interiors, The Delight Chairs by Exteta, che si arricchisce di nuove proposte, e la nuovissima Exteta x Riva, dove la passione del marchio per il mondo nautico si fonde con l'heritage esclusivo di Riva e delle sue iconiche imbarcazioni.

Le nuove creazioni firmate Exteta nascono quindi da ispirazioni diverse ma dialogano con le altre in perfetto equilibrio, in un'armonia di forme, funzioni e suggestioni. Scenografie che si incontrano e si fondono senza forzature, accomunate da un'estetica riconoscibile e da un linguaggio fatto di stile, vocazione e personalità. Ancora una volta, le linee sono fluide, organiche, ispirate alla natura e pensate

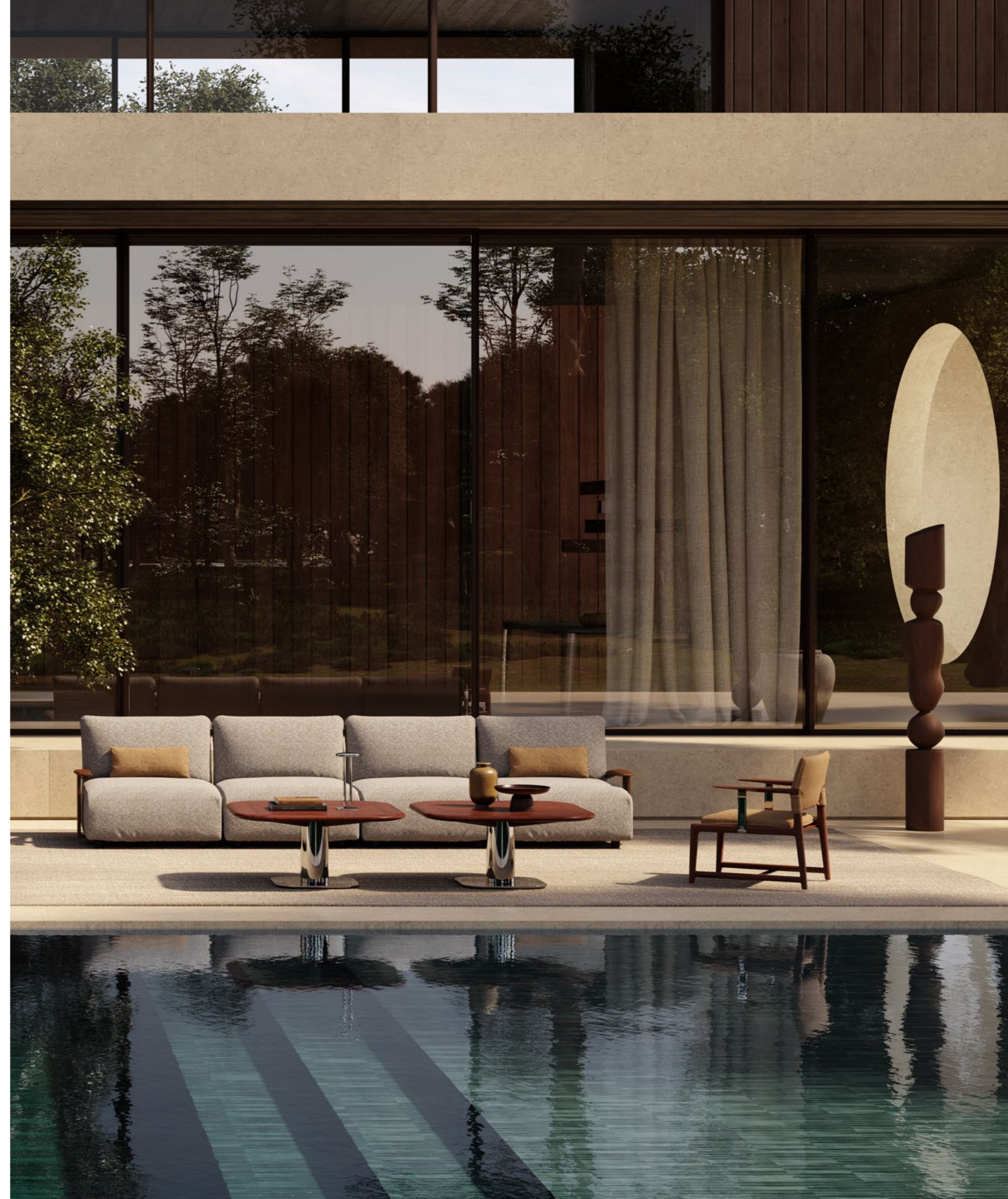



“Attention to detail, technical research, and formal study are Exteta's distinctive signature.”

“L'attenzione al dettaglio, la ricerca tecnica, lo studio formale sono il tratto distintivo di Exteta.”

STUDIOPEPE

EN Materials – fine woods, sculpted marbles, refined fabrics – are chosen for their quality and their ability to evoke tactile emotions.

The 2025 collection is guided by a clear design vision – a concept of space and architecture that enhances each piece, allowing it to stand out through its own material and formal identity. The imagined environments are hybrid, open, and free of clear boundaries. Indoors and outdoors blend into a continuous dialogue, where design moves freely in close connection with the surrounding landscape. Partitions don't divide, they embrace: filtering, lightweight surfaces that become the skin of the architecture, creating a refined play of transparencies, solids and voids, light and shadow.

This design vision embracing the new products reflects Exteta's language: a sensory architecture that conveys the brand's distinctive traits – signature design, refined tactile materials, and masterful craftsmanship. The setting in which the new products take shape is equally material: a measured combination of wood, stone, concrete, natural weaves, and metals.

A multisensory space becomes the canvas where Exteta's artistic touch emerges with depth, energy, and personality. Each product lives as part of the whole, yet also independently – almost nomadic: able to adapt, to move, to rewrite space with elegance and expressive character. Enriched with the latest novelties, the Exteta collection goes beyond furniture: it offers a true lifestyle experience, where comfort, beauty, and functionality coexist effortlessly. Conceived for the outdoors and the nautical world

IT per accompagnare la quotidianità. I materiali – legni pregiati, marmi scolpiti, tessuti raffinati – sono selezionati per la loro qualità e per la capacità di evocare emozioni al tatto.

Ad accompagnare la collezione 2025 c'è una precisa visione progettuale, un concept di spazio e di architettura che valorizza ogni proposta rendendola protagonista attraverso la propria identità materica e formale.

Gli ambienti immaginati sono ibridi, aperti, privi di confini netti. Interno ed esterno si fondono in un dialogo continuo, in cui il design si muove liberamente in stretta connessione con il paesaggio. Le partizioni non separano, ma avvolgono: superfici filtranti, leggere, che diventano pelle dell'architettura, dando vita a un gioco raffinato di trasparenze, pieni e vuoti, luci e ombre. Questa visione progettuale che abbraccia i nuovi prodotti riflette il linguaggio di Exteta: un'architettura sensoriale che racconta i tratti distintivi del brand – il design d'autore, i materiali ricercati e tattili, la maestria artigianale.

Lo scenario su cui i nuovi prodotti prendono forma è quindi altrettanto materico – una combinazione misurata di legno, pietra, cemento, intrecci naturali, metalli: uno spazio multisensoriale diventa la tela su cui il tocco artistico di Exteta può emergere con profondità, con energia, con personalità. Ogni prodotto vive nell'insieme, ma anche singolarmente, quasi nomade: capace di adattarsi, di spostarsi, di riscrivere lo spazio con eleganza e carattere espressivo.

La collezione Exteta, arricchita dalle ultime novità, va dunque oltre l'arredamento: propone una vera e propria

EN – contexts where design and performance must always coexist – it also adapts elegantly to indoor spaces, enriching them with its aesthetic value and technical quality. Every piece fits into a broader landscape, in dialogue with the surrounding environment. Whether it's a sea-view terrace, an urban garden, or the deck of a yacht, Exteta designs complete settings, immersed in nature and open to the landscape. This is how a new way of contemporary living unfolds: sensory, sophisticated, and capable of turning every outdoor moment into an experience to remember.

IT esperienza di lifestyle, dove comfort, bellezza e funzionalità convivono con naturalezza. Pensata per l'outdoor e per il mondo nautico – contesti in cui design e performance devono sempre coesistere – si adatta con eleganza anche agli spazi indoor, arricchendoli con il suo valore estetico e la qualità tecnica. Ogni elemento si inserisce in un panorama più ampio, in relazione all'ambiente circostante. Che si tratti di un terrazzo vista mare, di un giardino urbano o del ponte di uno yacht, Exteta disegna scenari completi, immersi nella natura e aperti al paesaggio. Così si delinea un nuovo abitare contemporaneo: sensoriale, sofisticato, capace di trasformare ogni momento all'aperto in un'esperienza da ricordare.



THE WISDOM OF HANDS

EN The heritage that inspires, nourishes, and strengthens Exteta is deeply rooted in a land of excellence: Brianza, the historic cradle of fine cabinetmaking and the homeland of Italian design. It is in this region—vibrant with ancient knowledge and contemporary creativity—that the soul of the brand comes to life, shaped by the talent of master artisans and the design ingenuity that have always defined this district. A living legacy, made of precise gestures, passed-down memory, and constant innovation, which is expressed in Exteta's collections as the authentic embodiment of timeless elegance.

Each creation is born from centuries-old know-how, reinterpreted through a gaze fixed on the present: every piece is crafted and finished entirely by hand, in a meticulous process that enhances every detail, every finish, every nuance. Furniture that carries the

IT L'heritage che ispira, nutre e dà forza a Exteta affonda le sue radici in un territorio d'eccellenza: la Brianza, culla storica dell'alta ebanisteria e patria del design italiano. È in questa terra vibrante di saperi antichi e creatività contemporanea che prende vita l'anima del marchio, forgiata dal talento dei maestri artigiani e dal genio progettuale che da sempre definiscono questo distretto. Un'eredità viva, fatta di gesti precisi, di memoria tramandata e di innovazione costante, che si traduce nelle collezioni Exteta come espressione autentica di un'eleganza senza tempo. Ogni creazione nasce da un know-how secolare, reinterpretedato con uno sguardo rivolto al presente: i pezzi sono realizzati e rifiniti interamente a mano, in un processo minuzioso che valorizza ogni dettaglio, ogni finitura, ogni sfumatura. Arredi che portano con sé l'impronta irripetibile del gesto umano.





EN unrepeatable imprint of the human touch. Skilled hands transform raw materials into objects that tell a story of everyday beauty. Wood, marble, stone, metals, and fabrics become surfaces to explore, canvases upon which Exteta's artisanal gestures and design vision intertwine. It is within this balance that a contemporary way of living takes shape—defined by comfort, elegance, and functionality. From material selection to the final workmanship, each phase is part of a precise process: every creation is designed to be consistently comfortable, long-lasting over time, and resilient in any environment. But above all, it is the highly bespoke nature of this manufacturing approach that makes each piece unique: every furnishing element can be customized down to the smallest detail, shaped according to individual desires and the identity of the space it inhabits. Because at Exteta, excellence is always something authentic and unrepeatable.

IT Mani esperte trasformano dunque le materie prime in oggetti che raccontano un'idea di bellezza quotidiana. Legno, marmo, pietra, metalli e tessuti diventano superfici da esplorare, tele su cui si intrecciano il gesto artigianale e la visione progettuale di Exteta. È in questo equilibrio che prende forma un abitare contemporaneo fatto di comfort, eleganza e funzionalità. Dalla scelta dei materiali alla lavorazione finale, ogni fase è parte di un processo accurato: ogni creazione è ideata per essere confortevole sempre, durevole nel tempo, resistente in ogni contesto. Ma è soprattutto la natura altamente sartoriale di questo approccio manifatturiero a rendere ogni pezzo unico: ogni arredo può essere personalizzato nei minimi dettagli, modellato sui desideri individuali e sull'identità dello spazio che lo accoglie. Perché l'eccellenza, da Exteta, è sempre un fatto autentico e irripetibile.

Collaborations

EN A shared passion, a creative dialogue born from kindred visions and translated into furnishings rich in allure. Exteta intertwines its identity with that of brands and designers from the world of luxury and fine craftsmanship, giving rise to collaborations that become fertile ground for exploring new forms, new languages, new emotions. It is in this refined exchange that the brand's values—artisanal excellence, aesthetic research, and attention to detail—are reinterpreted through contemporary proposals capable of expanding Exteta's expressive boundaries and enriching its universe of style. Original collections and re-editions by design masters come together in a narrative in constant evolution, where history and innovation coexist in perfect harmony.

IT Una passione condivisa, un dialogo creativo che nasce da visioni affini e si traduce in opere d'arredo ricche di fascino. Exteta intreccia la propria identità con quella di marchi e designer provenienti dal mondo del lusso e dell'alto artigianato, dando vita a collaborazioni che diventano terreno fertile per esplorare nuove forme, nuovi linguaggi, nuove emozioni. È in questa contaminazione raffinata che i valori del brand – l'eccellenza artigianale, la ricerca estetica, l'attenzione al dettaglio – vengono reinterpretati attraverso proposte contemporanee, in grado di espandere i confini espressivi di Exteta e di arricchire il suo universo di stile. Collezioni inedite e riedizioni d'autore si affiancano in un racconto in continua evoluzione, dove storia e innovazione convivono in perfetto equilibrio.

Exteta × Riva

EN A lifestyle inspired by the nautical world. An exclusive collaboration that elevates contemporary elegance. Exteta x Riva is the new outdoor furniture collection that brings the iconic charm of boating into the world of living, transforming every space into an experience of pure style. Designed by Massimo Castagna, the collection draws inspiration from the most authentic soul of Riva—the skilled craftsmanship of Carlo Riva, the timeless myth of the 1960s “Dolce Vita,” and the extraordinary artisanal mastery of his boats. A story reinterpreted with modern sensitivity through Exteta’s design vision, which conveys its essence through details, materials, and proportions. From the refinement of precious Sapelli mahogany, enhanced by the sheen of stainless steel, comes a complete and coherent collection where design and memory merge into a new, sophisticated interpretation of outdoor living.

IT Uno stile di vita ispirato al mondo nautico. Una collaborazione esclusiva che sublima l'eleganza contemporanea. Exteta x Riva è la nuova collezione di arredi outdoor che trasferisce il fascino iconico della nautica nel mondo dell'abitare, trasformando ogni ambiente in un'esperienza di puro stile. Firmata da Massimo Castagna, la collezione trae ispirazione dall'anima più autentica di Riva – la sapiente manifattura di Carlo Riva, il mito intramontabile della “Dolce vita” degli anni Sessanta, l'altissima artigianalità delle sue imbarcazioni. Una storia reinterpretata con sensibilità moderna dalla visione progettuale di Exteta, che ne traduce l'essenza attraverso dettagli, materiali e proporzioni. Dalla raffinatezza del pregiato mogano Sapelli, esaltata dalla lucentezza dell'acciaio inox, nasce una collezione completa e coerente, in cui design e memoria si fondono in una nuova, sofisticata interpretazione del vivere all'aperto.

Exteta x Riva Armchair, Lounge Table, Lamp
- design by Massimo Castagna

EXTETA
×
Riva





EXTETA x RIVA
Sofa



EXTETA x RIVA
Sofa with Wooden Armrests



EXTETA x RIVA
Dining Table



EXTETA x RIVA
Lounge Table



EXTETA x RIVA
Coffee Table



EXTETA x RIVA
Lounge Chair



EXTETA x RIVA
Lounge Chair with Wooden Armrests



EXTETA x RIVA
Chair



EXTETA x RIVA
Armchair



EXTETA x RIVA
Sun Lounger



EXTETA x RIVA
Lamp



Loro Piana Interiors, The Delight Chairs by Exteta

EN Creating refined design objects through the use of noble materials: from this shared vision comes Loro Piana Interiors, The Delight Chairs by Exteta, a collection that unites the timeless elegance of Loro Piana fabrics with Exteta's design and artisanal mastery. At the heart of the project lies the essence of "quiet luxury," the stylistic hallmark of Loro Piana's fashion collections: a whispered elegance, never ostentatious, celebrating the quality of raw materials, exclusive workmanship, and an aesthetic that transcends trends. Designed by Paola Navone OTTO Studio, the collection tells the story of an exceptional encounter: the sophisticated weaves of Loro Piana Interiors fabrics intertwine with the artistry of Exteta, which handcrafts the prized Sapelli mahogany to give form to furnishings with iconic presence.

IT Creare oggetti di design raffinato attraverso l'uso di materiali nobili: è da questa visione condivisa che nasce Loro Piana Interiors, The Delight Chairs by Exteta, una collezione che unisce l'eleganza senza tempo dei tessuti Loro Piana alla maestria progettuale e artigianale di Exteta. Al centro della proposta si rivela l'essenza del "quiet luxury", cifra stilistica che definisce le collezioni moda di Loro Piana: un'eleganza sussurrata, mai ostentata, che celebra la qualità delle materie prime, le lavorazioni esclusive e un'estetica in grado di oltrepassare le mode. Disegnata da Paola Navone OTTO Studio, la collezione racconta un incontro d'eccellenza: le trame sofisticate dei tessuti Loro Piana Interiors si intrecciano con l'arte ebanistica di Exteta, che modella a mano il pregiato mogano Sapelli per dare forma ad arredi dalla presenza iconica.



INTERIORS

The Delight Chairs

by

EXTETA

LPIDC12 Dining Chair, LPIDC14 Wooden Dining Table
- Loro Piana Interiors, The Delight Chairs by Exteta
- design by Paola Navone OTTO Studio / Stecca Light
- design by Massimo Castagna



LPIDC01
Folding Director's Chair



LPIDC02
Armchair



LPIDC03
Foldable Stool



LPIDC09
Wooden Coffee Table



LPIDC10
Coffee Table



LPIDC07
Side Tables



LPIDC05
Rocking Chair



LPIDC12
Dining Chair



LPIDC13
Bar Stool



LPIDC04
Sunbed



LPIDC15
Portable Lamp



LPIDC08
Lounge Chair

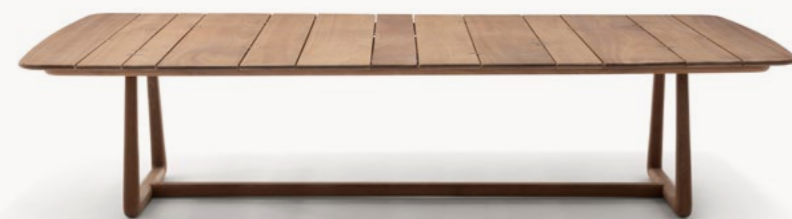

LPIDC14
Dining Table



LPIDC06
Table



LPIDC08
Sofa



LPIDC11
Modular Sofa



Jacquemus + Exteta, special re-edition of Locus Solus series

EN Authorial design, its visionary force, creativity that travels through time. From this heritage comes the collaboration between Exteta and Jacquemus: a spontaneous, sincere, and subtly ironic encounter that brings back to light an icon of Italian design, reinterpreted with a fresh perspective. The protagonist of this capsule collection is the legendary Locus Solus, designed in 1964 by Gae Aulenti. A collection with a pop spirit, defined by bold lines and vintage charm, now revisited in fabrics and colors with the audacious yet refined touch of Simon Porte Jacquemus—designer, collector, and admirer of Aulenti's work. The stainless steel tubing, shaped into elegant curved profiles, becomes the distinctive signature of the collection, a fil rouge connecting Exteta's craftsmanship with Jacquemus' unconventional aesthetic approach. For a vibrant and daring outdoor proposal that dares to stand out, without ever compromising on quality or essential beauty.

IT Il design d'autore, la sua forza visionaria, la creatività che attraversa il tempo. Da questo heritage nasce la collaborazione tra Exteta e Jacquemus: un incontro spontaneo, sincero e leggermente ironico, che ha riportato alla luce un'icona del design italiano, reinterpretata con uno sguardo nuovo. Protagonista della capsule collection è la leggendaria Locus Solus, disegnata nel 1964 da Gae Aulenti. Una collezione dallo spirito pop, caratterizzata da linee forti e da un fascino vintage, oggi rivisitata nei tessuti e nei colori dal tocco audace e raffinato di Simon Porte Jacquemus, stilista, collezionista e ammiratore dell'opera di Aulenti. Il tubolare in acciaio inox, modellato in eleganti profili curvi, diventa il tratto distintivo della collezione, un fil rouge che unisce il carattere manifatturiero di Exteta all'approccio estetico non convenzionale di Jacquemus. Per una proposta outdoor vivace e audace, che non teme di osare senza rinunciare alla qualità e alla bellezza essenziale.

JACQUEMUS

EXTETA

SPECIAL RE-EDITION OF LOCUS SOLUS 1964
DESIGNED BY GAE AULENTI

Locus Solus Chair, Locus Solus Armchair
- Jacquemus + Exteta special re-edition





LOCUS SOLUS
Armchair



LOCUS SOLUS
Pouf



LOCUS SOLUS
Dining Table



LOCUS SOLUS
Loveseat



LOCUS SOLUS
Chair



LOCUS SOLUS
Low Table



LOCUS SOLUS
Sun Lounger



Breathe the Outdoors

CHAPTER I	The Charm of the Essential	40
CHAPTER II	Immersed in Nature	78
CHAPTER III	Between Sky and City	114



Authentic surfaces,
NATURAL MATERIALS, and
WARM TONES define an
architecture that speaks softly.
ESSENTIAL LINES engage
with light, air, and landscape,
in **A RHYTHM OF VOLUMES**,
transparencies, and breath.

Superfici autentiche, materiali naturali e tonalità calde definiscono un'architettura che parla sottovoce. Linee essenziali dialogano con luce, aria e paesaggio, in un ritmo di volumi, trasparenze e respiro.





Modernista Armchair, Serele Coffee Table, Hikari Lamp, Periscopio Sofa,
Periscopio Armchair, Periscopio Side Table, Periscopio Arc Coffee Table
- design by Studiopepe



Modernista Armchair, Hikari Lamp, Periscopio Side Table
- design by Studiopepe



Caprera Sofa Modular, Panarea Coffee Table - design by Massimo Castagna
/ Nereide Basket - design by Studiopepe



Caprera Sofa Modular - design by Massimo Castagna
/ Astratto Coffee Table - design by Studiopepe



Caprera Sofa Modular - design by Massimo Castagna
/ Sunset Lounge Table - design by Paola Navone OTTO Studio
/ Shell Armchair - design by Studiopepe





Caprera Sofa Modular, Panarea Coffee Table - design by Massimo Castagna
/ Nereide Basket - design by Studiopepe





LPIDC04 Sunbed, LPIDC15 Portable Lamp - Loro Piana Interiors,
The Delight Chairs by Exteta - design by Paola Navone OTTO Studio
/ Stone Round Coffee Table - design by Ludovica + Roberto Palomba





Amalfi Kitchen, Stecca Light Applique - design by Massimo Castagna
/ LPIDC13 Bar Stool - Loro Piana Interiors, The Delight Chairs by Exteta
- design by Paola Navone OTTO Studio



Amalfi Kitchen - design by Massimo Castagna



10th Joint Stone Dining Table - design by Massimo Castagna
/ Shell Armchair - design by Studiopepe



LPIDC12 Dining Chair, LPIDC14 Wooden Dining Table, LPIDC02 Armchair, LPIDC09 Wooden Coffee Table, LPIDC08 Sofa - Loro Piana Interiors, The Delight Chairs by Exteta - design by Paola Navone
OTTO Studio / Stecca Light - design by Massimo Castagna

LPIDC12 Dining Chair, LPIDC14 Wooden Dining Table - Loro Piana Interiors,
The Delight Chairs by Exteta - design by Paola Navone OTTO Studio
/ Stecca Light - design by Massimo Castagna





LPIDC12 Dining Chair, LPIDC14 Wooden Dining Table, LPIDC02 Armchair, LPIDC09 Wooden Coffee Table, LPIDC08 Sofa, LPIDC07 Side Table, LPIDC15 Portable Lamp - Loro Piana Interiors, The Delight Chairs by Exteta - design by Paola Navone OTTO Studio / Stecca Light - design by Massimo Castagna



FABRIC
Paradou 01



LEATHER
Nabuk Nocciola



FABRIC
Paradou 03



FABRIC
Loro Piana Dehors Boucle Shaded White

FABRIC
Loro Piana Dehors Eze Kasha



FABRIC
Loro Piana Dehors
Eze Kasha Spago



STONE
Travertino Antico



FABRIC
Muzza 05



WOOD
Untreated
Natural
Mahogany



Astratto Coffee Table 176



Amalfi Kitchen 166



Caprera Sofa Modular 180



LPIDC09 Wooden Coffee Table.. 232



LPIDC12 Dining Chair 242



LPIDC13 Bar Stool 244

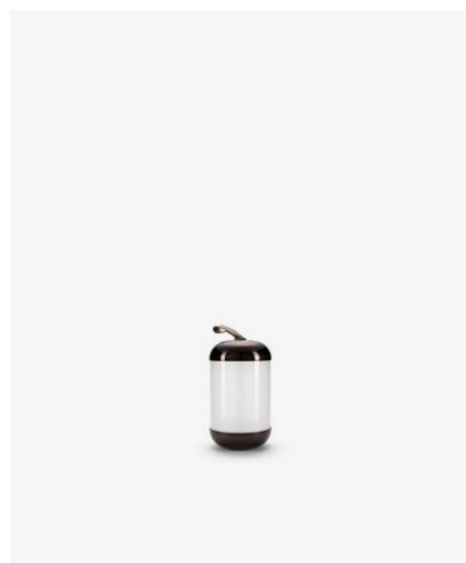

Hikari Lamp 210



10th Joint Stone Dining Table 156

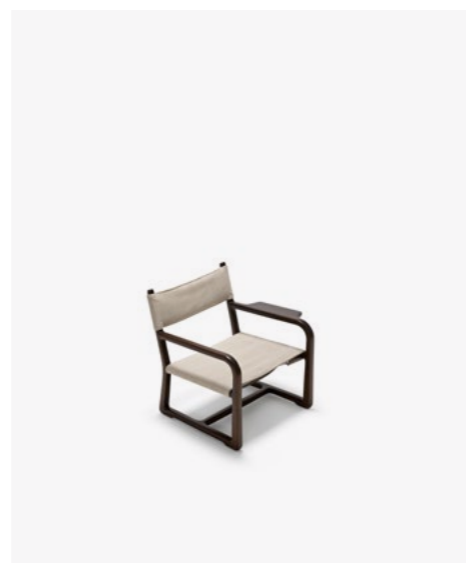

LPIDC02 Armchair 216



LPIDC14 Wooden Dining Table 246



LPIDC15 Portable Lamp 248

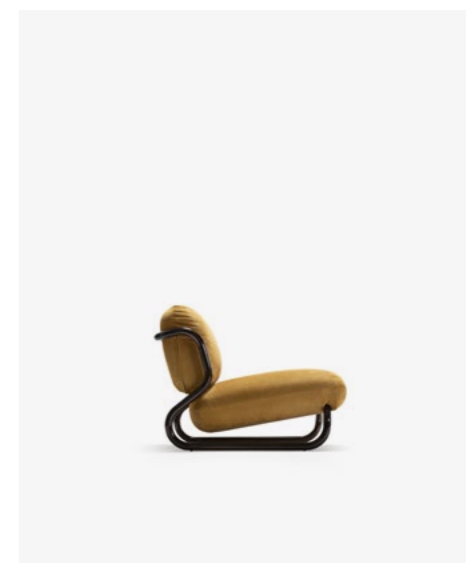

Modernista Armchair 258



LPIDC04 Sunbed 220

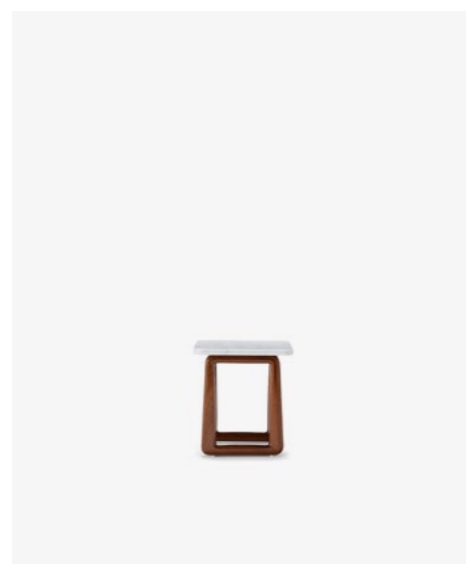

LPIDC07 Side Table 226

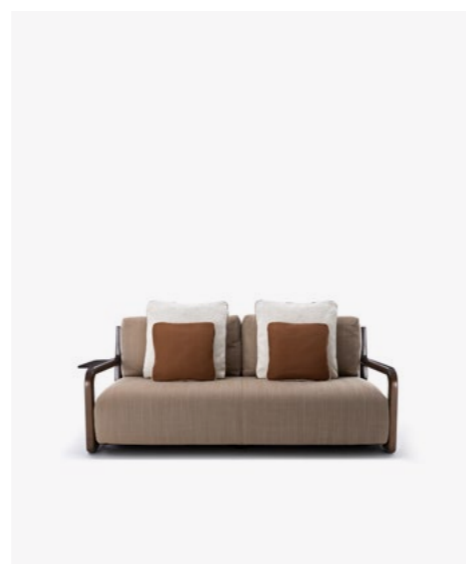

LPIDC08 Sofa 230



Nereide Basket 266

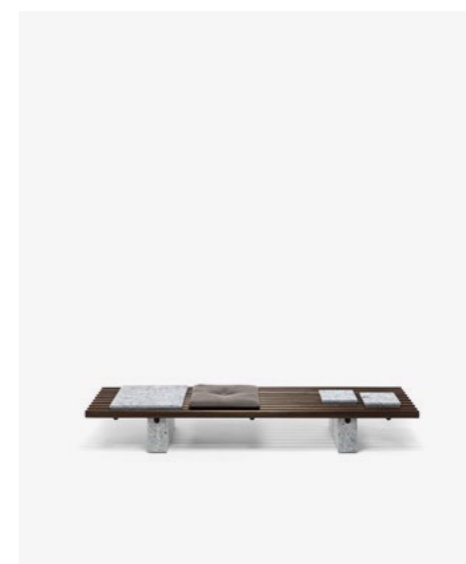

Panarea Coffee Table 270



Periscopio Armchair 272



Periscopio Sofa 278



Periscopio Coffee Table 276



Serele Coffee Table 282



Terra Fresca Carpet 304

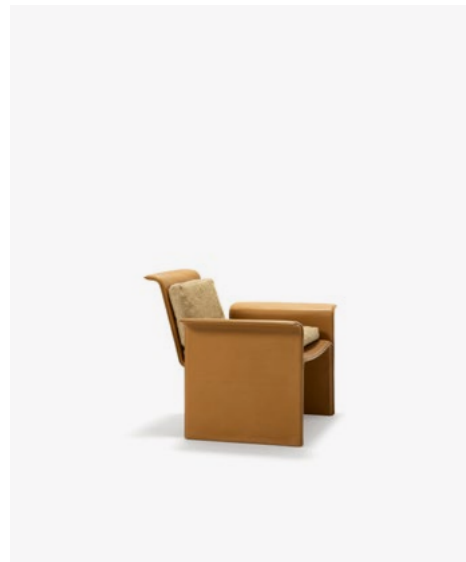

Shell Armchair 284



Shell Chair 286



Stecca Light 288



Stecca Light Applique 290

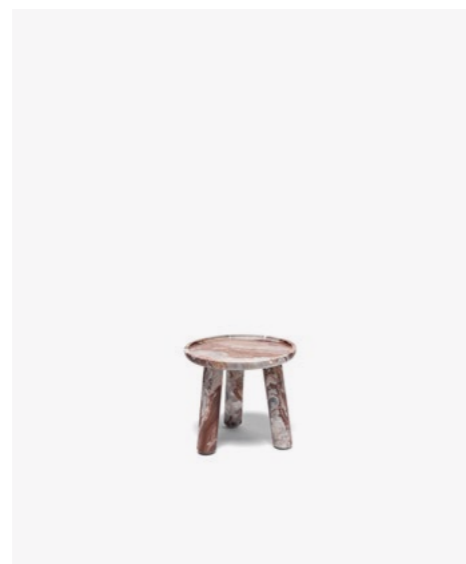

Stone Round Coffee Table 294

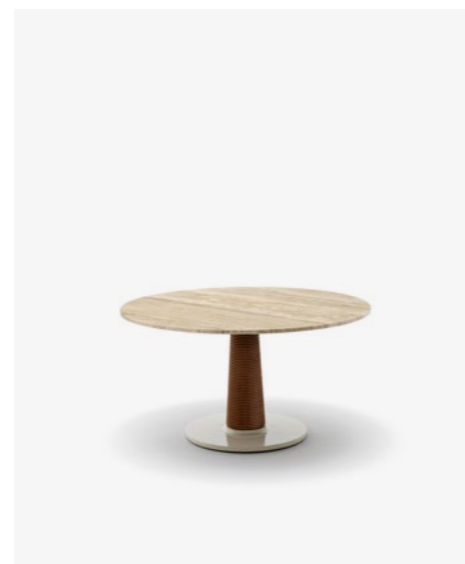

Sunset Lounge Table 302

NATURE enters living spaces effortlessly, blending with the interiors. **A MODERNIST HOME** blurs the boundaries **BETWEEN INSIDE AND OUT**, embracing verandas and gardens in a **POETIC BALANCE** of material, landscape, and architecture.



La natura entra con spontaneità negli spazi dell'abitare, fondendosi con gli interni. Una casa modernista sfuma i confini tra dentro e fuori, accogliendo verande e giardini in un equilibrio poetico tra materia, paesaggio e architettura.





LPIDC08 Lounge Chair, LPIDC07 Side Table, LPIDC10 Coffee Table, LPIDC11 Modular Sofa - Loro Piana Interiors,
 The Delight Chairs by Exteta - design by Paola Navone OTTO Studio / Moonlight Dining Table, Moonlight Soft
 Chair with Armrests - design by Paola Navone OTTO Studio / Stecca Light - design by Massimo Castagna



Moonlight Dining Table, Moonlight Soft Chair with Armrests - design by Paola Navone OTTO Studio / Stecca Light - design by Massimo Castagna







Mochi Sofa, Mochi Armchair, Serele Coffee Table, Nereide Basket
- design by Studiopepe



10th Kitchen - design by Massimo Castagna



10th Kitchen, Levante Stool - design by Massimo Castagna





Exteta x Riva Lamp, Dining Table, Chair
- design by Massimo Castagna



Exteta x Riva Sun Lounger
- design by Massimo Castagna



Exteta x Riva Sofa, Sofa with Wooden Armrests, Lounge Chair with Wooden Armrests, Coffee Table, Lamp, Armchair - design by Massimo Castagna



Exteta x Riva Sofa with Wooden Armrests, Coffee Table, Lamp, Armchair
- design by Massimo Castagna





Exteta x Riva Sofa, Sofa with Wooden Armrests, Lounge Chair with Wooden Armrests, Coffee Table, Lamp, Armchair - design by Massimo Castagna



FABRIC
Brea 79



LEATHER
Shark S011

FABRIC
Loro Piana Dehors Eze Muschio



FABRIC
Loro Piana
Dehors Kasha
Muschio



FABRIC
Iseo 15



MARBLE
Sahara Grey



STONE
Ostuni



WOOD
Matt Mahogany



FABRIC
Loro Piana Dehors Sabi Sands Light Grey



FABRIC
Paradou 03



10th Kitchen 158

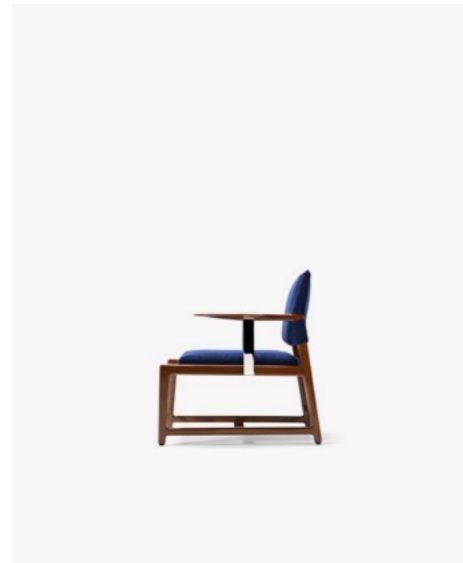

Exteta x Riva Armchair 186

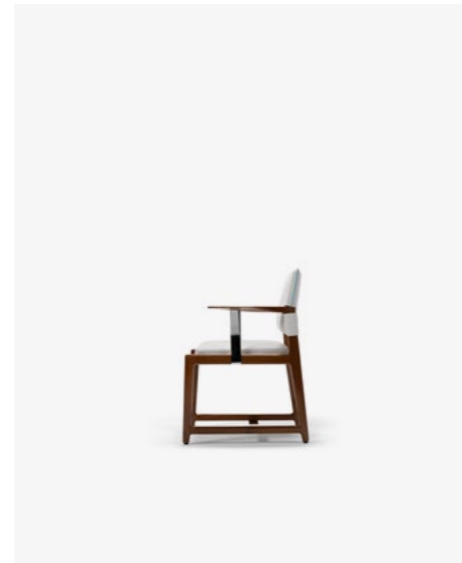

Exteta x Riva Chair 188



Exteta x Riva Sun Lounger 208

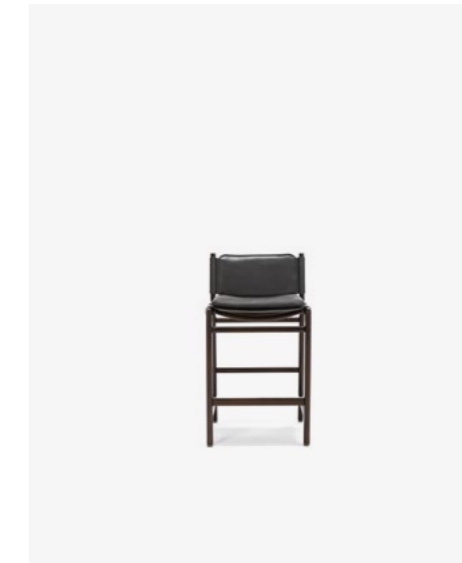

Levante Stool 212



LPIDC07 Side Table 226

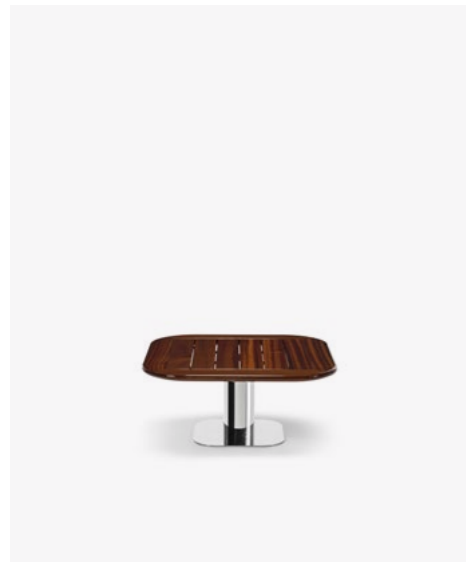

Exteta x Riva Coffee Table 190

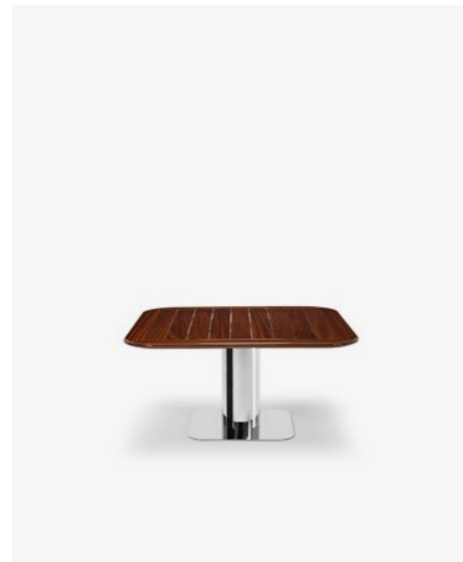

Exteta x Riva Dining Table 192

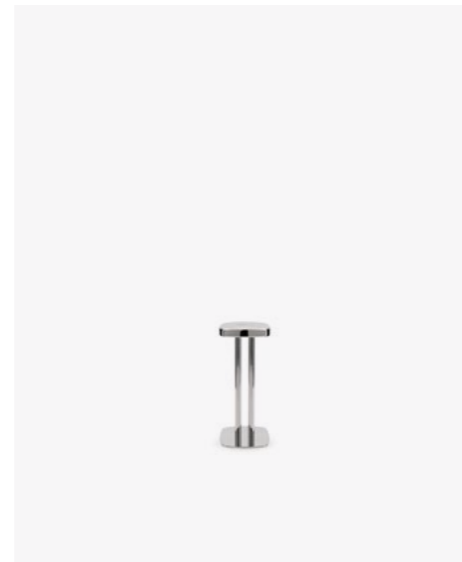

Exteta x Riva Lamp 194

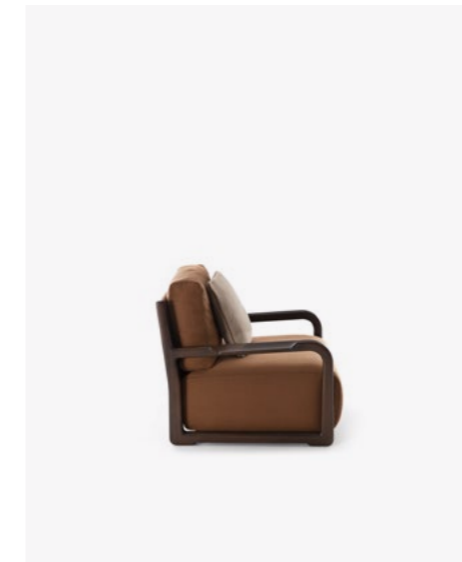

LPIDC08 Lounge Chair 228

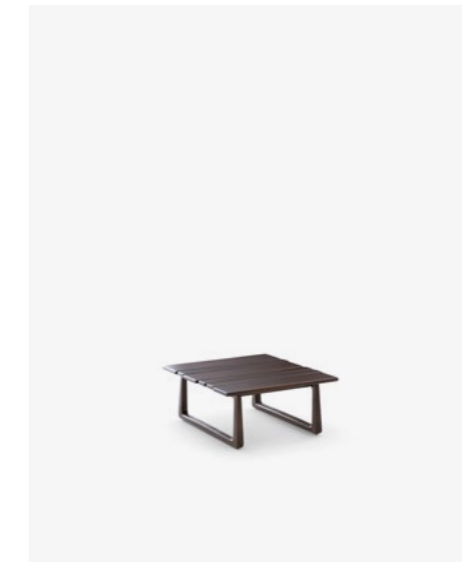

LPIDC09 Wooden Coffee Table 232



LPIDC10 Coffee Table 234



Exteta x Riva Lounge Chair 198



Exteta x Riva Sofa 202

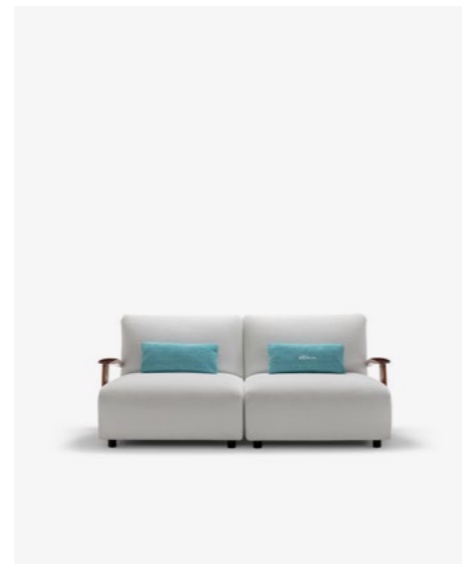

Exteta x Riva Sofa with Wooden Armrests 204



LPIDC11 Modular Sofa 236



LPIDC15 Portable Lamp 248



Mochi Armchair 252



Mochi Sofa 256



Moonlight Dining Table 262



Moonlight Soft Chair 264

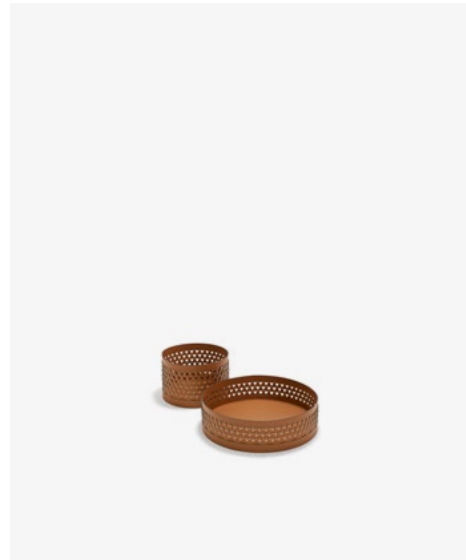

Nereide Basket 266



Serele Coffee Table 120 282



Stecca Light Applique 290



Stecca Light 288

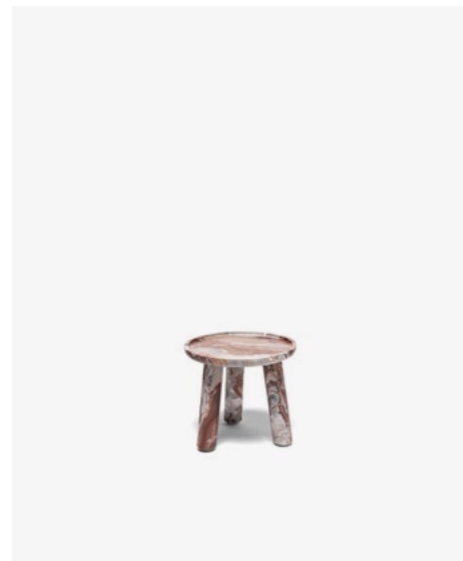

Stone Round Coffee Table 294



Terra Fresca Carpet 304

Amid urban chaos, a contemporary **PENTHOUSE** becomes an **INTIMATE RETREAT**. A suspended, harmonious space welcomes with interiors balanced between form and function. A slow, deep way of living, where **DISCREET LUXURY** transcends time.

Nel caos urbano, una penthouse contemporanea diventa rifugio intimo. Spazio sospeso e armonico, accoglie con interni misurati tra forma e funzione. Un abitare lento e profondo, dove il lusso è discreto e capace di superare il tempo.







Tellaro Sun Lounger, 10th Star Coffee Table - design by Massimo Castagna
/ Nereide Basket - design by Studiopepe





Michelangelo Dinner Table, Stecca Light - design by Massimo Castagna
/ Modernista Chair - design by Studiopepe



Michelangelo Dinner Table, Stecca Light, Amalfi Kitchen - design by Massimo Castagna
/ Modernista Chair - design by Studiopepe / LPIDC13 Bar Stool - Loro Piana Interiors,
The Delight Chairs by Exteta - design by Paola Navone OTTO Studio



LPIDC13 Bar Stool - Loro Piana Interiors, The Delight Chairs by Exteta - design by Paola Navone OTTO Studio / Amalfi Kitchen - design by Massimo Castagna







Caprera Sofa Modular, Biscuit Coffee Table, No-Glue Chair, Stecca Light Freestanding - design by Massimo Castagna



Shell Armchair, Hikari Lamp - design by Studiopepe / 10th Star Coffee Table
- design by Massimo Castagna



Stringa Sofa 1963, Stringa Armchair 1963, Stringa Coffee Table 1963
- design by Gae Aulenti



Stringa Sofa 1963, Stringa Armchair 1963, Stringa Coffee Table 1963
- design by Gae Aulenti





FABRIC
Loro Piana Dehors Natte
White Ecrú 04

LEATHER
Shark S523



MARBLE
Steven Black



MARBLE
Arabescato
Orobico Red



STONE
Ostuni



FABRIC
Loro Piana Dehors
Sabi Sands Shaded
White

FABRIC
Loro Piana Dehors Sabi Sands Kasha



WOOD
Matt Barrique



LEATHER
Cammello



LEATHER
Nabuk Noce



10th Prato Fiorito Floor Light 160

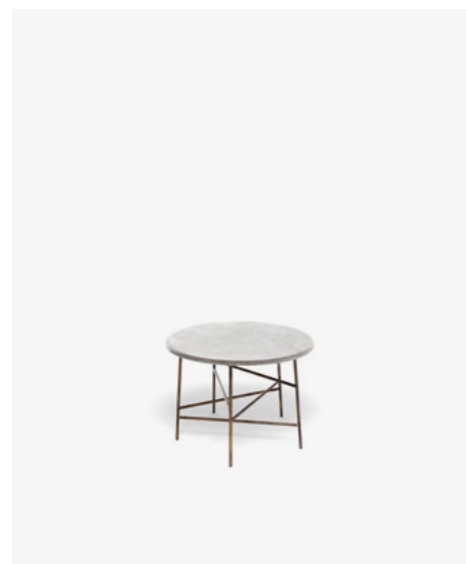

10th Star Coffee Table 162



10th Tellaro Sun Lounger 164

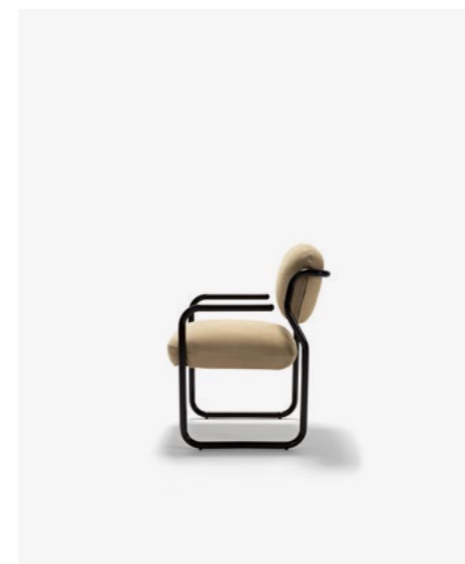

Modernista Chair 260



Nereide Basket 266

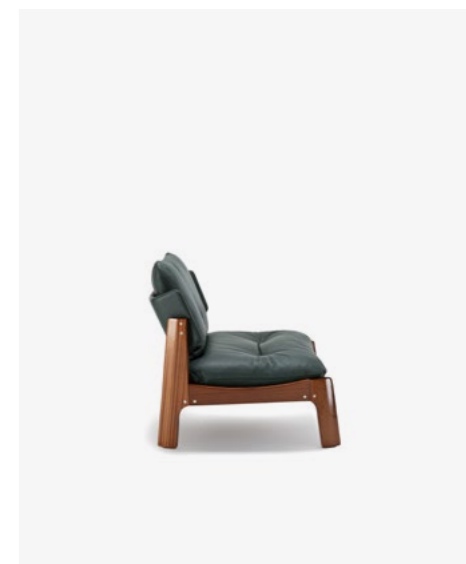

No-Glue Armchair 268



Amalfi Kitchen 166



Biscuit Coffee Table 178



Caprera Sofa Modular 180

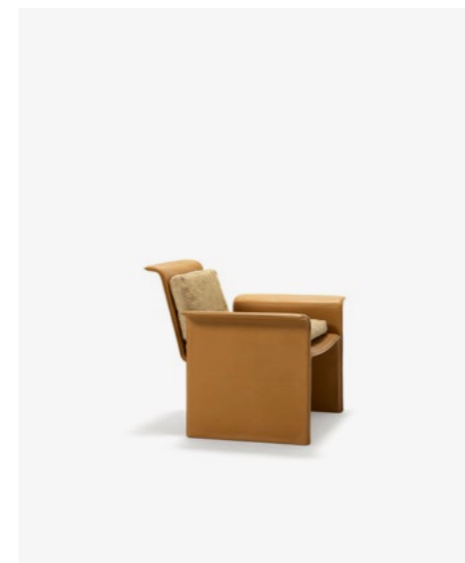

Shell Armchair 284



Stecca Light 288



Stecca Light Freestanding 292

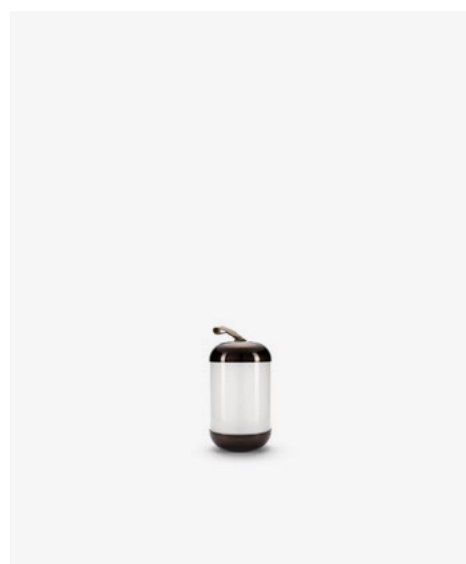

Hikari Lamp 210



LPIDC13 Bar Stool 244



Michelangelo Dinner Table 250

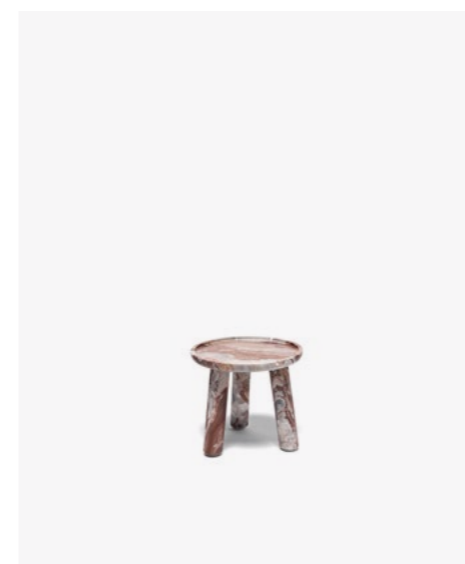

Stone Round Coffee Table 294

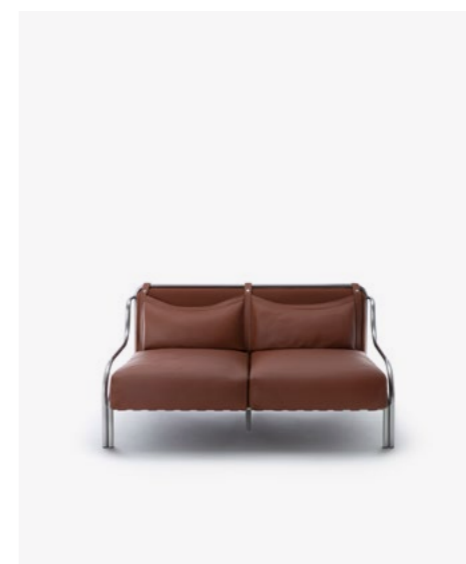

Stringa Sofa 1963 300

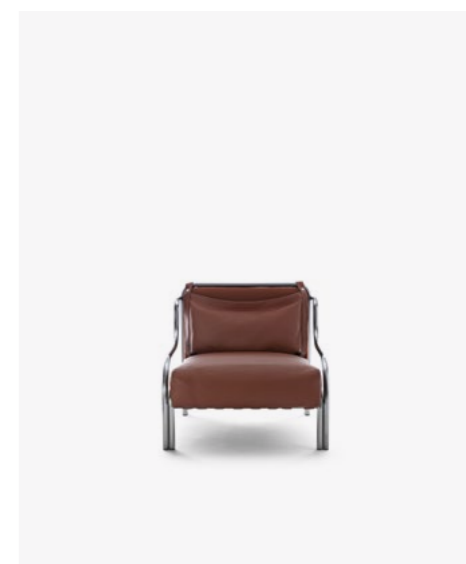

Stringa Armchair 1963 296

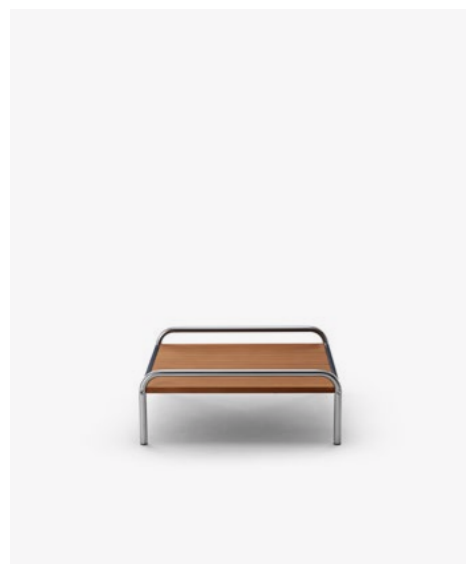

Stringa Coffee Table 1963 298



Terra Fresca Carpet304

Designers

EN Creative experimentation, evolving design languages, and dialogue with the great Masters of design. Since its origins, Exteta has made collaboration with internationally renowned creatives one of the pillars of its identity, shaping a vision of outdoor lifestyle that blends design and craftsmanship, technical innovation and artisanal know-how. The result is a wide-ranging, diverse collection that interprets the brand's values through original creations and signature re-editions. Designers such as Massimo Castagna, Paola Navone OTTO Studio, Ludovica + Roberto Palomba, and Studiopepe work alongside masters like Franco Albini, Gae Aulenti, and Marco Zanuso. A collective narrative made of converging visions and expertise, giving life to collections capable of transcending time and redefining the boundaries of living.

IT Sperimentazione creativa, linguaggi progettuali in continua evoluzione, dialogo con i grandi Maestri del design. Fin dalle sue origini, Exteta ha fatto della collaborazione con i creativi di fama internazionale uno dei pilastri della propria identità, dando forma a un'idea di outdoor lifestyle che unisce design e artigianalità, innovazione tecnica e savoir-faire manifatturiero. Il risultato è una collezione ampia ed eterogenea che interpreta i valori del marchio attraverso proposte inedite e riedizioni d'autore. Designer come Massimo Castagna, Paola Navone OTTO Studio, Ludovica + Roberto Palomba e Studiopepe si affiancano a Maestri come Franco Albini, Gae Aulenti e Marco Zanuso. Un racconto corale, fatto di visioni e saperi che si incontrano, per dar vita a collezioni capaci di attraversare il tempo e i confini dell'abitare.

FRANCO ALBINI

EN Franco Albini, visionary Italian architect, was born in 1905 in Brianza. After graduating from the Politecnico di Milano, he worked at Giò Ponti's studio, where he connected with leading international figures. A key figure of Italian Rationalism, he was known for the rigor of his design approach and his modern, understated language, always guided by a strong social ethic: the architect as a professional serving the community. He designed museums, exhibitions, furnishings, and contributed to the Milan Metro project. His legacy continues to influence the worlds of design and architecture—a vision of beauty rooted in precision and coherence.

IT Franco Albini, visionario architetto italiano, nasce nel 1905 in Brianza. Dopo la laurea al Politecnico di Milano, lavora nello studio di Giò Ponti, dove entra in contatto con figure di rilievo internazionale. Esponente del razionalismo italiano, è noto per il rigore del suo approccio progettuale e per il linguaggio moderno e silenzioso, sempre guidato da una forte etica sociale: l'architetto come professionista al servizio della comunità. Ha firmato musei, allestimenti, arredi e contribuito alla progettazione della metropolitana di Milano. La sua eredità continua a influenzare il mondo del design e dell'architettura: un'idea di bellezza fondata su precisione e coerenza.

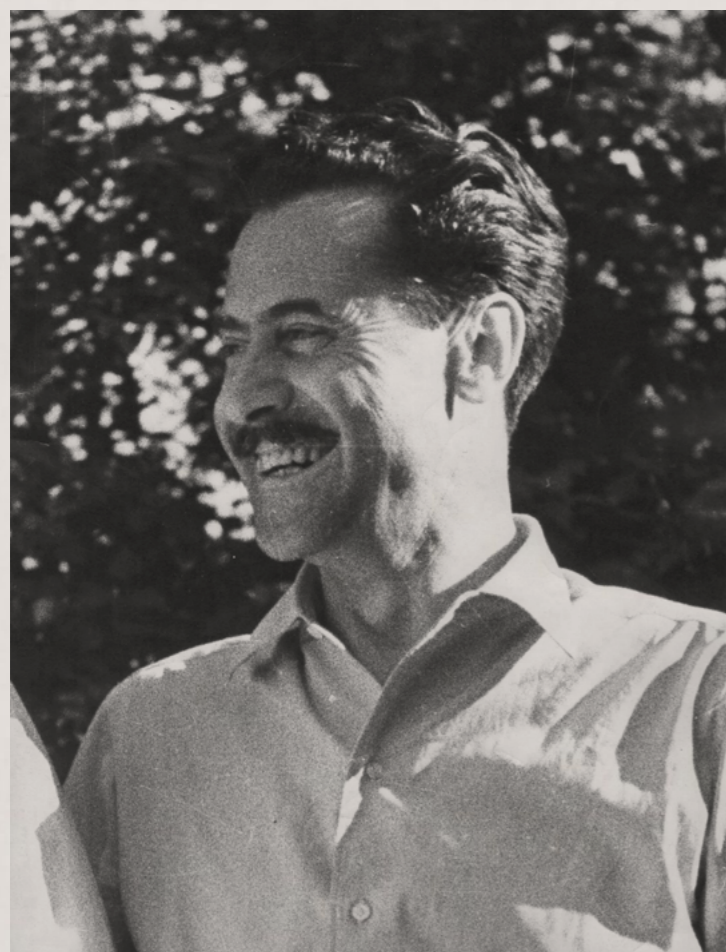

GAE AULENTI

EN Gaetana Emilia Aulenti, known as Gae, was born in 1927 in Friuli. A graduate in Architecture from the Politecnico di Milano, she worked in industrial, interior, and exhibition design, creating museums and iconic objects that became status symbols. A leading figure in a male-dominated field, she transformed spaces and reimagined ways of living. Among her most renowned works: the Gare d'Orsay, the Centre Pompidou Gallery, and the Scuderie del Quirinale. Her bold, often unconventional style embraced strong materials, clean lines, and spaces that tell stories. A reference point for generations of architects, she showed how architecture can be poetic, daring, and deeply human.

IT Gaetana Emilia Aulenti, in arte Gae, nasce nel 1927 in Friuli. Laureata in Architettura al Politecnico di Milano, si è occupata di industrial, interior ed exhibition design, firmando musei e oggetti iconici divenuti status symbol. Figura influente in un settore dominato dagli uomini, ha saputo trasformare gli spazi e reinventare il modo di abitare. Tra i suoi progetti più noti: la Gare d'Orsay, la Galleria del Centre Pompidou e le Scuderie del Quirinale. Il suo stile, deciso e spesso in controtendenza, si esprime attraverso materiali forti, linee nette e ambienti che raccontano storie. Punto di riferimento per generazioni di architetti, ha mostrato come l'architettura possa essere poetica, audace e profondamente umana.



MASSIMO CASTAGNA

EN Massimo Castagna was born in 1957 in Lombardy. After graduating in Architecture from the Politecnico di Milano, he founded the AD Architettura studio in 1986, beginning a path that blends design and architecture into a coherent vision. He has extensive experience in designing residential and commercial buildings, hotels, interiors, and furniture, along with roles as consultant and art director for leading companies. Among his key works is the "Piramide" laboratory for the Everest-K2-CNR scientific committee, built in Nepal at 5,050 meters. With an integrated vision, he merges architecture and design into a language of creative coherence and design freedom.

IT Massimo Castagna nasce nel 1957 in Lombardia. Dopo la laurea in Architettura al Politecnico, fonda nel 1986 lo studio AD Architettura, dando avvio a un percorso che unisce design e architettura in una visione coerente. Vanta una lunga esperienza nella progettazione di edifici residenziali, commerciali, hotel, interior design e arredi, oltre a collaborazioni come consulente e direttore artistico per aziende del settore. Tra i progetti principali, il laboratorio "Piramide" per il comitato scientifico Everest-K2-CNR, realizzato in Nepal a 5.050 metri. Con una visione integrata, ha saputo fondere architettura e design in un linguaggio di libertà progettuale e coerenza creativa.



10th Collection **156, 178, 250, 270**; Amalfi Kitchen **166**;
Exteta x Riva **186**; Levante **212**; No-Glue **268**; Stecca **288**

PAOLA NAVONE OTTO STUDIO

EN Paola Navone was born in Turin, where she studied architecture at the Politecnico. In Milan, she worked with great masters such as Mendini, Sottsass, and Branzi, expanding her techniques, visions, and references. Architect, product designer, art director, and interior designer, she is a multifaceted figure and a true citizen of the world. Her stimulating and innovative language earned her the Osaka Design Award as early as 1983. She has signed numerous international projects for hotels, restaurants, and public spaces. Frank, dreamy, and eclectic, her work blends the colors of the Global South with Western traditions. She founded Otto Studio and collaborates with major names in contemporary design.

IT Paola Navone nasce a Torino, dove studia architettura al Politecnico. A Milano lavora con grandi maestri come Mendini, Sottsass e Branzi, ampliando tecniche, visioni e riferimenti. Architetto, product designer, art director e interior designer, è una figura poliedrica e cittadina del mondo. Il suo linguaggio stimolante e innovativo le vale, già nel 1983, il Design Award di Osaka. Firma numerosi progetti internazionali per hotel, ristoranti e spazi pubblici. Schietta, sognatrice ed eclettica, nei suoi lavori unisce i colori del Sud del mondo alle tradizioni dell'Occidente. Fonda lo studio Otto e collabora con le firme più importanti del design contemporaneo.



Loro Piana Interiors, The Delight Chairs by Exteta **214**;
Moonlight **262**; Sunset **302**

LUDOVICA SERAFINI + ROBERTO PALOMBA

EN Ludovica Serafini and Roberto Palomba, architects, live and work in Milan. In 1994, they founded Palomba Serafini Associati. They design architecture and exhibitions worldwide, collaborate with major brands, and oversee art direction. Their furniture features organic yet defined forms, exploring all types of design. Their approach is philosophical, seeking essence, balance, and conceptual well-being—not just aesthetic results. Their style is creative yet controlled, with a free and cross-disciplinary language. Their work stems from analyzing evolving behaviors. They have received numerous awards, including the Compasso d'Oro, Red Dot, and EDIDA.

IT Ludovica e Roberto Palomba, architetti, vivono e lavorano a Milano. Nel 1994 fondano Palomba Serafini Associati. Progettano architetture ed esposizioni in tutto il mondo, collaborano con importanti brand e curano direzioni artistiche. Disegnano arredi dalle forme organiche e definite, esplorando tutte le tipologie. Il loro approccio è filosofico: cercano l'essenza, l'equilibrio e il benessere concettuale, non solo il risultato estetico. Si distinguono per un segno creativo e controllato, un lessico libero e trasversale. I loro progetti nascono dall'analisi dei cambiamenti nei comportamenti. Hanno ricevuto numerosi premi, tra cui il Compasso d'Oro, il Red Dot e l'EDIDA.



Stone Round **294**

STUDIOPEPE

EN Studiopepe is one of the most eclectic names in Milanese design. Driven by a passion for alchemy, pastel tones, and materials, Arianna Lelli Mami and Chiara Di Pinto founded the studio in 2006. Their projects, marked by strong visual impact, span interiors, product design, art direction, and installations, with a multidisciplinary approach rooted in research and experimentation. This all-female studio creates concepts for boutiques, hotels, homes, and artistic projects. Poetic yet rigorous, their design stands out for its consistent vision and strong, essential forms that embrace diverse fields with style and coherence.

IT Studiopepe è una delle firme più eclettiche del design milanese. Ispirate da una passione per l'alchimia, i colori pastello e i materiali, Arianna Lelli Mami e Chiara Di Pinto fondano lo studio nel 2006. I loro progetti, dal forte impatto estetico, spaziano tra interior, prodotto, direzione artistica e installazioni, con un approccio multidisciplinare fondato su ricerca e sperimentazione. Lo studio, tutto al femminile, realizza concept per negozi, hotel, abitazioni e progetti artistici. Poetico ma rigoroso, il loro design si distingue per una visione coerente e segni forti dal valore essenziale, che abbracciano ambiti diversi con stile e coerenza.



Astratto **176**; Hikari **210**; Mochi **252**; Modernista **258**;
Periscopio **272**; Serele **262**; Nereide **266**; Shell **284**

MARCO ZANUSO

EN Marco Zanuso was born in Milan in 1926. Architect, designer, urbanist, and academic, he stood out for his innovative approach. A founder of industrial design, he explored mass production and the use of new materials and technologies for everyday objects. He experimented with techniques from the automotive sector to simplify furniture production. He created iconic pieces winning seven Compasso d'Oro and six Triennale awards. Beyond furniture, he designed radios, phones, TVs, and sewing machines. He was editor-in-chief of Domus and co-founder of ADI.

IT Marco Zanuso nasce a Milano nel 1926. Architetto, designer, urbanista e accademico, si distingue fin da subito per un approccio innovativo. Tra i fondatori del design industriale, studia la produzione seriale e l'uso di nuovi materiali e tecnologie applicati agli oggetti di uso quotidiano. Sperimenta tecniche derivate dal settore automobilistico per semplificare la produzione di arredi. Ha firmato oggetti iconici premiati con sette Compassi d'Oro e sei riconoscimenti alla Triennale di Milano, oggi esposti al MoMA di New York e alla Collezione Permanente della Triennale. Oltre agli arredi, ha disegnato radio, telefoni, TV e macchine per cucire. È stato caporedattore di Domus e co-fondatore dell'ADI.

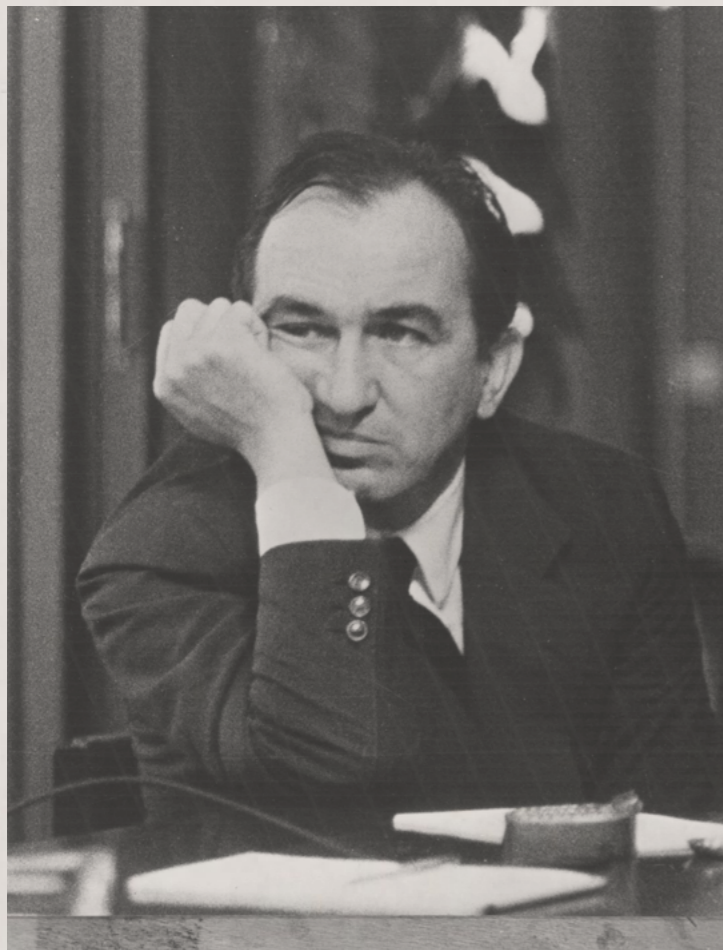

Products

10TH JOINT STONE DINING TABLE

Massimo Castagna



TOP.....marble / stone
LEGS AND DETAILS powder coated stainless steel

DIMENSIONS
295x150xh75 cm / 600x150xh75 cm

PP 58-59, 64-65

EN Suspended between tension and monumentality, lightness and material strength, this table expresses a perfect balance of contrasts. The authentic veined marble top rests on an asymmetrical base with stainless steel columns. A fusion of furniture and architecture.

IT Sospeso tra tensione e monumentalità, leggerezza e forza materica, questo tavolo esprime un perfetto equilibrio di contrasti. Il piano in marmo, autentico e venato, poggia su una base asimmetrica con colonne in acciaio inox. Un incontro tra arredo e architettura.

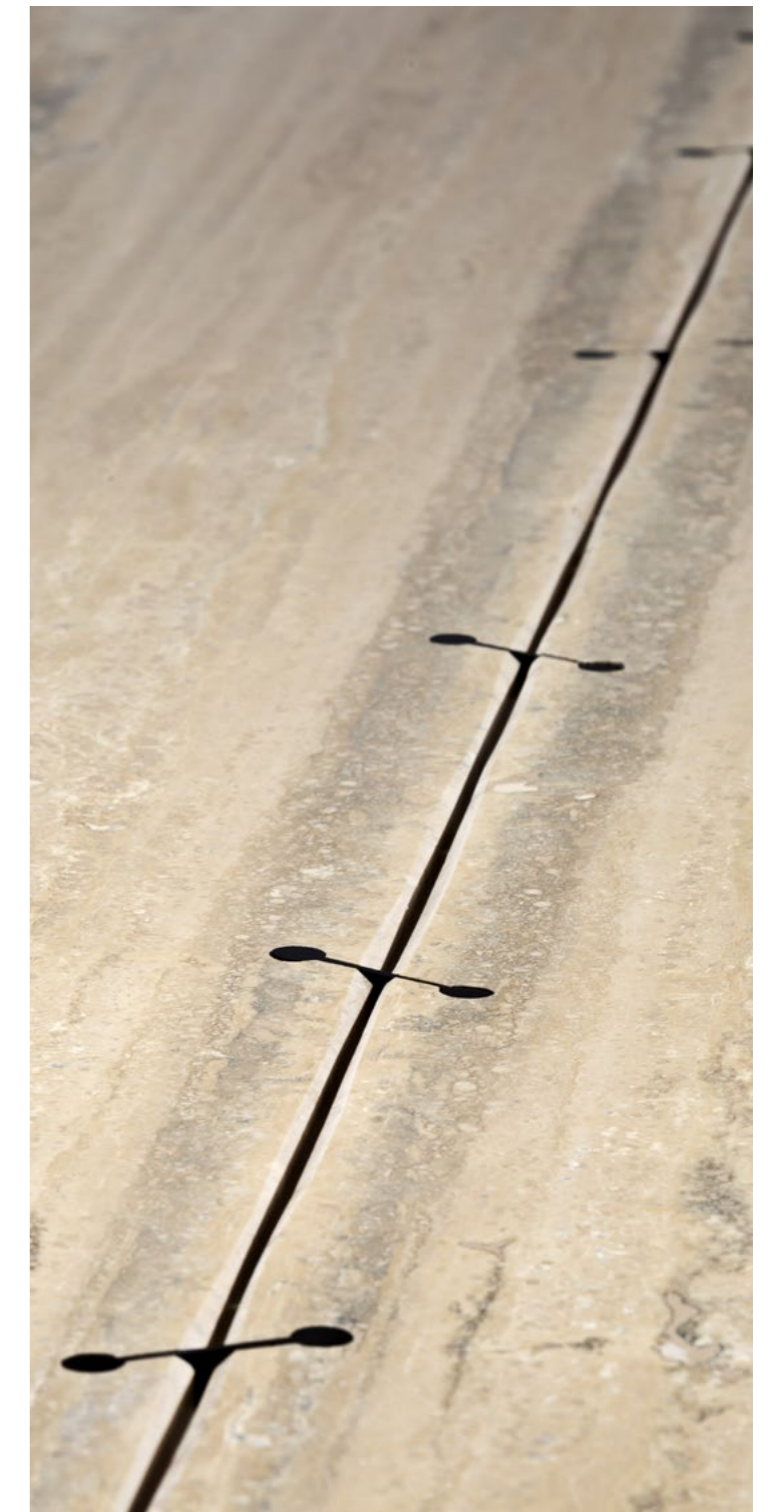

10TH KITCHEN

Massimo Castagna



KITCHEN COUNTER marble / stone
 APPLIANCES stainless steel
 KITCHEN LEGS antiqued and polished stainless steel

DIMENSIONS
 280x90xh90 cm

PP 90-91, 93

EN With the visual and material strength of suspended architecture, 10th Kitchen bridges indoor and outdoor. An open-air convivial island with indoor kitchen functionality, hidden beneath a sliding top that doubles as protection and a practical table when opened.

IT Con la forza visiva e materica di un'architettura sospesa, 10th Kitchen è un ponte tra indoor e outdoor. Un'isola conviviale open air con funzionalità da cucina interna, celate da un piano scorrevole che funge da protezione e, una volta aperto, da tavolo.

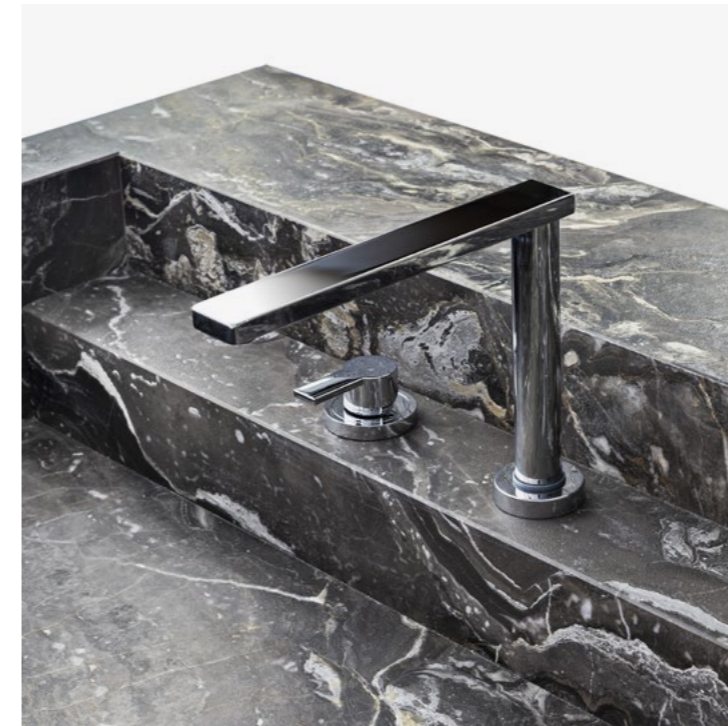

10TH PRATO FIORITO FLOOR LIGHT

Massimo Castagna



STRUCTURE burnished brass
DIFFUSER.....methacrylate

DIMENSIONS
120×25×h130 cm

PP 10, 115-116. 119

EN Like flowers swaying in the wind, Massimo Castagna's lamps bend on stems of varying heights, anchored to brass bases. Slender and light, they culminate in glowing spheres, creating a magical spread of light that evokes natural scenes.

IT Come fiori mossi dal vento, le lampade di Massimo Castagna si flettono su steli di diverse altezze, ancorate a basi in ottone. Slanciate e leggere, culminano in sfere luminose, dando vita a una magica distesa di luce che richiama scenari naturali.

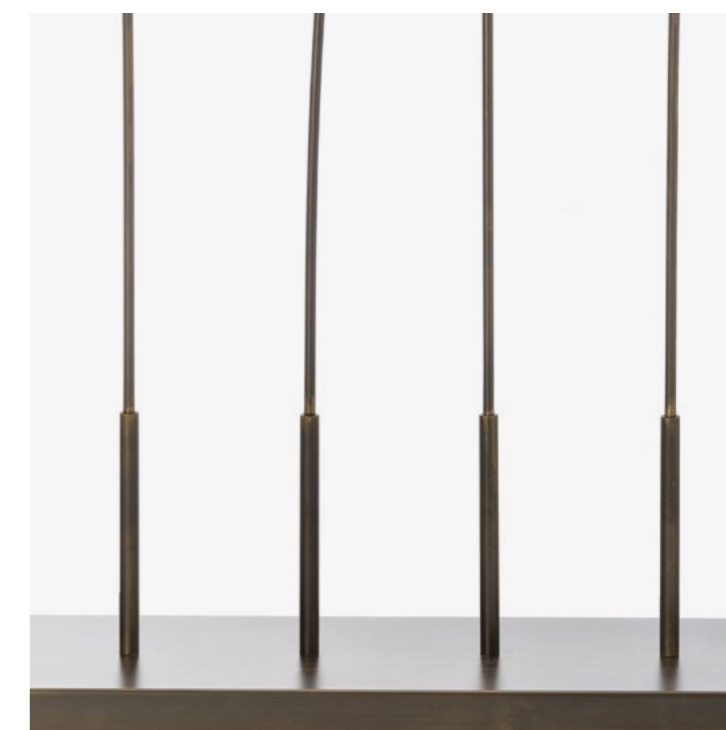

**10TH STAR
COFFEE TABLE**
Massimo Castagna



STRUCTURE lacquered stainless steel

DIMENSIONS
ø60×h40 cm / ø40×h50 cm

PP 115-118, 132

EN The 10th Star Coffee Table by Massimo Castagna contrasts glossy lacquered tops with a sleek steel frame. Durable outdoors, it pairs essential lines with refined materials, available in various sizes and finishes.

IT Il 10th Star Coffee Table di Massimo Castagna unisce top laccati lucidi a una struttura in acciaio essenziale. Resistente all'outdoor, combina linee pure e materiali ricercati, disponibile in varie misure e finiture.

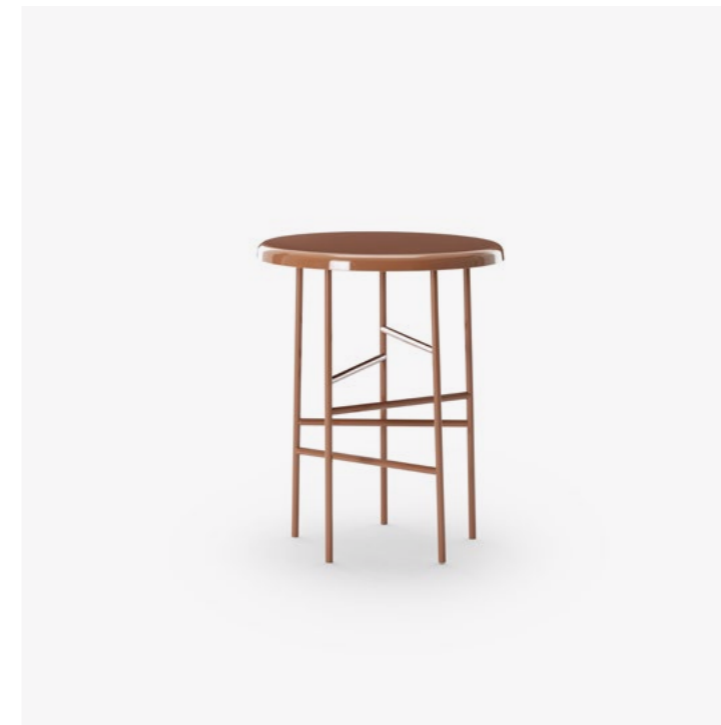

10TH TELLARO SUN LOUNGER

Massimo Castagna



STRUCTURE	sapelli mahogany
PADDING	polyestere
INTERNAL LINING.....	polyethylene
EXTERNAL LINING.....	fabric or leather
HARDWARE	stainless steel 316

DIMENSIONS
210x90xh33 cm

PP 13, 115-119

EN Il relax sotto il sole incontra l'eleganza anni '60 e l'atmosfera della Dolce Vita. Il lettino 10th, in pregiato mogano Sapelli, ha linee morbide e imbottitura confortevole. Schienale reclinabile, ruote opzionali e versione double per un benessere condiviso.

IT Relaxing under the sun meets '60s elegance and the Dolce Vita atmosphere. The 10th lounger, crafted from fine Sapelli mahogany, features soft lines and comfortable padding. Reclining backrest, optional wheels, and a double version for shared relaxation.

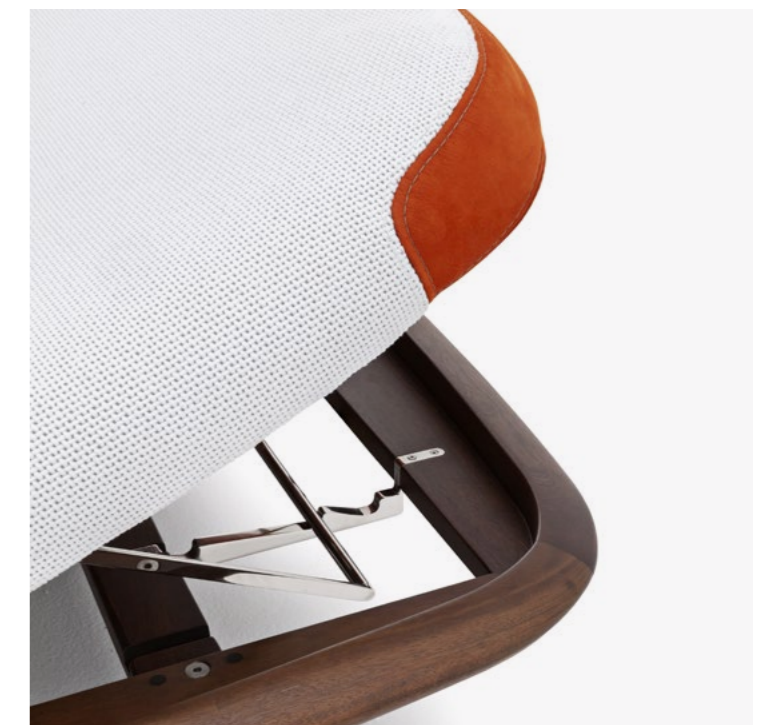

**AMALFI
KITCHEN**
Massimo Castagna

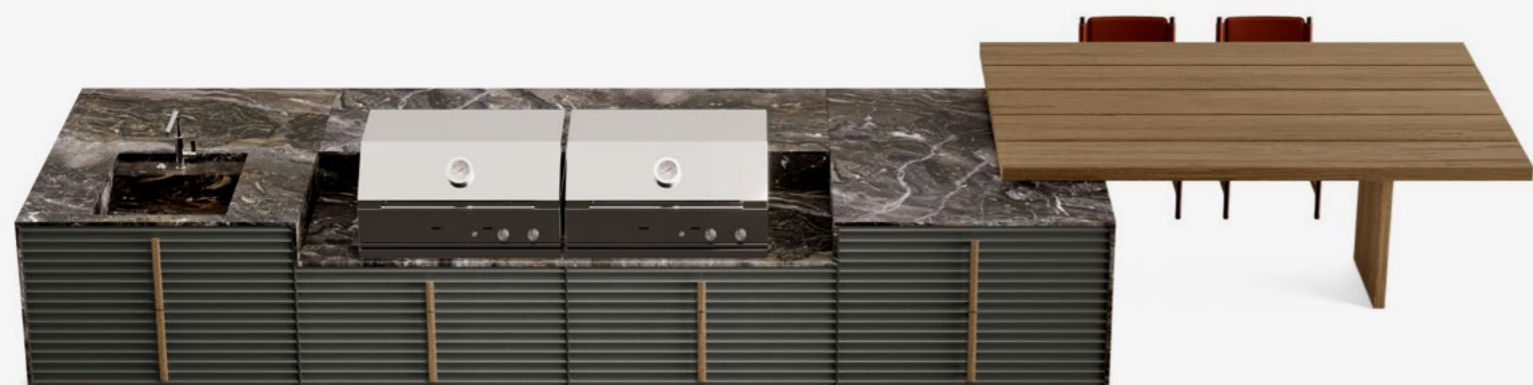

TOP.....marble or stone
 STRUCTUREstainless steel
 DOORSmatt powder coated aluminium
 HANDLES..... sapelli mahogany

DIMENSIONS
 See following pages
 /vedi le pagine seguenti

PP 58-63, 120-121, 124-127

EN The Amalfi kitchen opens the heart of the home to the outdoors: spacious, modular, customizable, blending the joy of cooking with the art of hosting. Stainless steel and aluminum volumes with fluted fronts, vertical handles, and integrated accessories.

IT La cucina Amalfi apre il cuore della casa verso l'esterno: ampia, modulare e personalizzabile, unisce il piacere del cucinare all'arte del ricevere. In acciaio inox e alluminio, ha volumi geometrici, frontali scanalati, maniglia verticale e accessori integrati.



TECHNICAL DATA

Storage bases 60 - Pull-out drawers - 60x70x87 cm

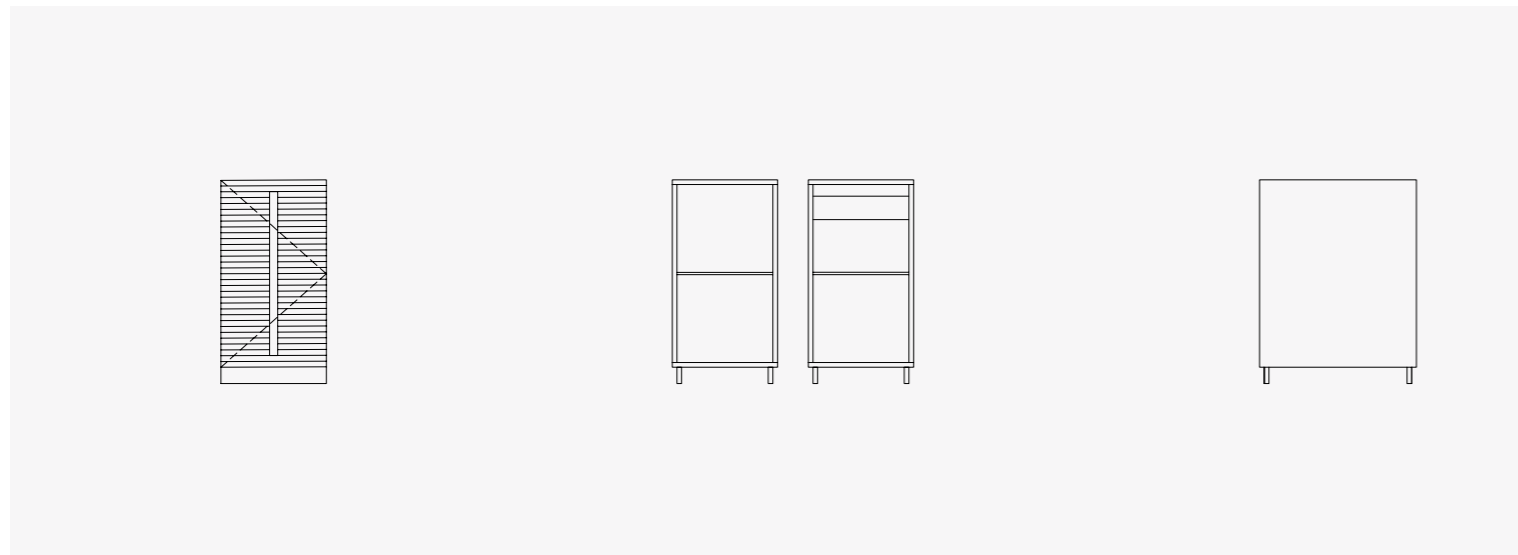

Storage bases 45 - Pull-out drawers - 45x70x87 cm

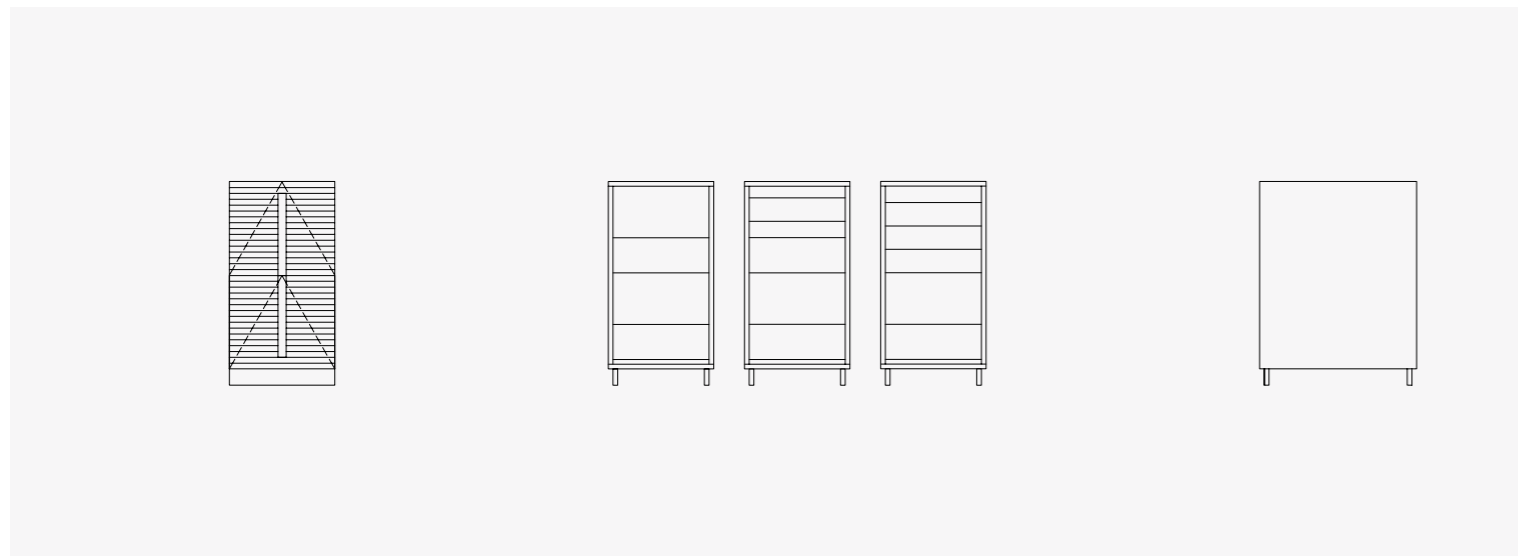

Storage bases 60 - Hinged door - 60x70x87 cm

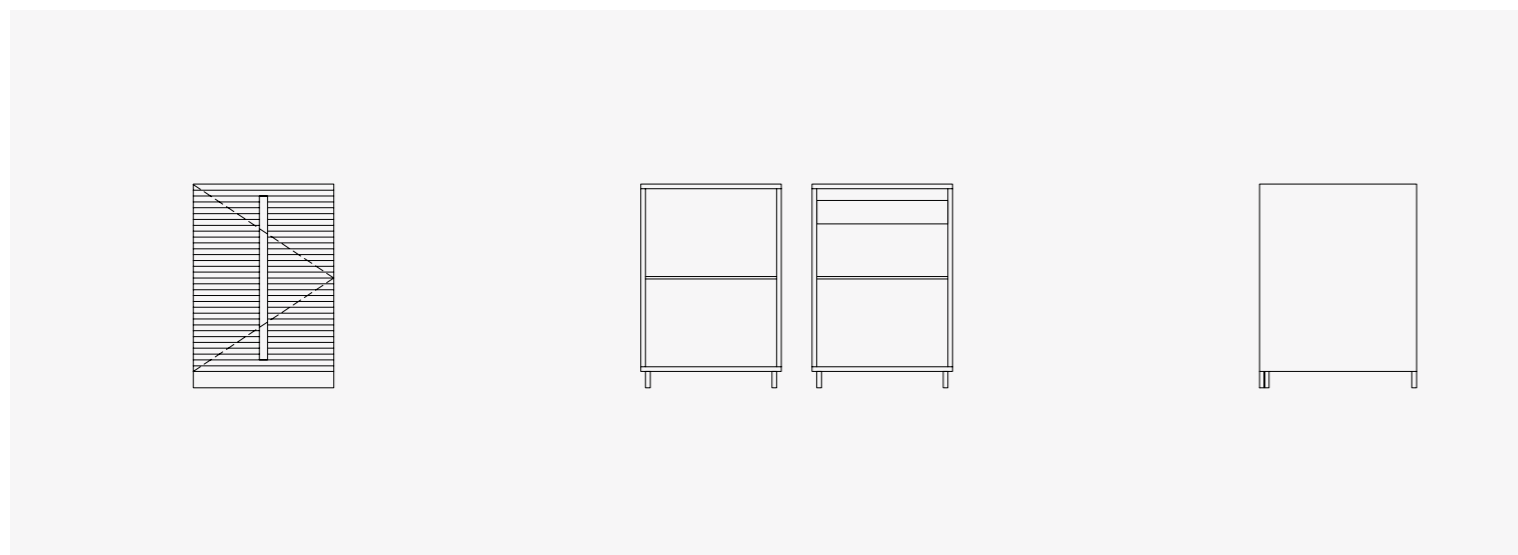

Storage bases 60 - Pull-out drawers - 60x70x87 cm

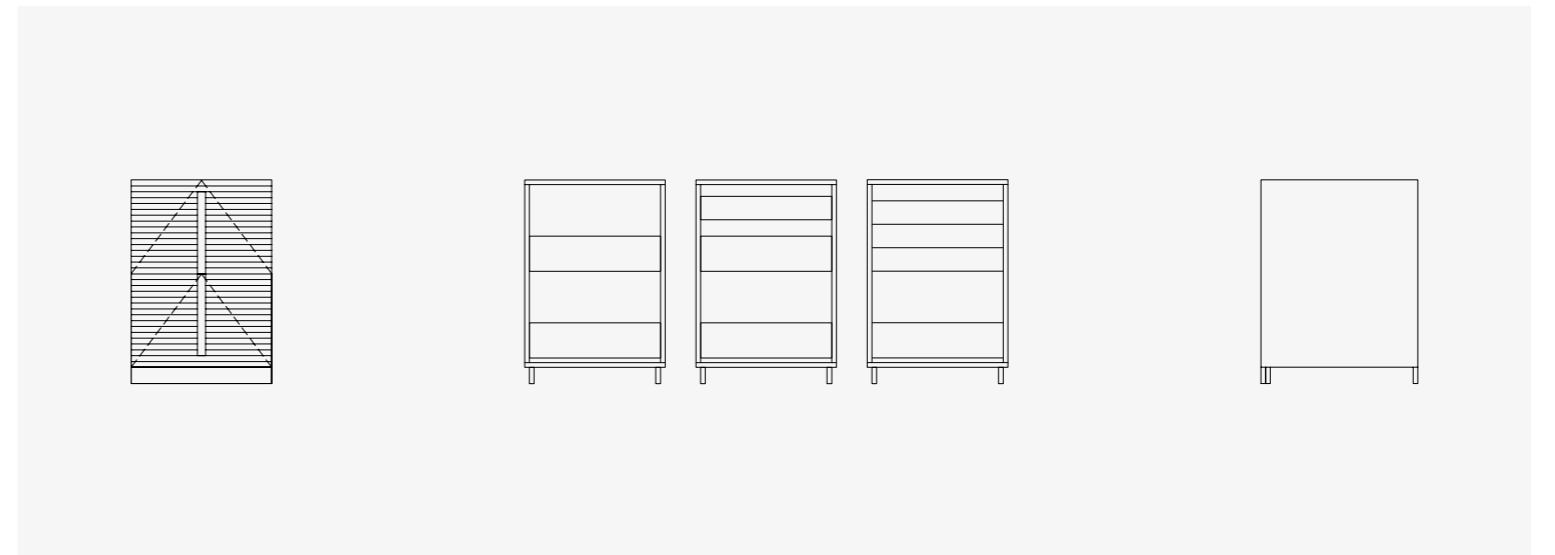

Storage bases 90 - Hinged door - 90x70x87 cm

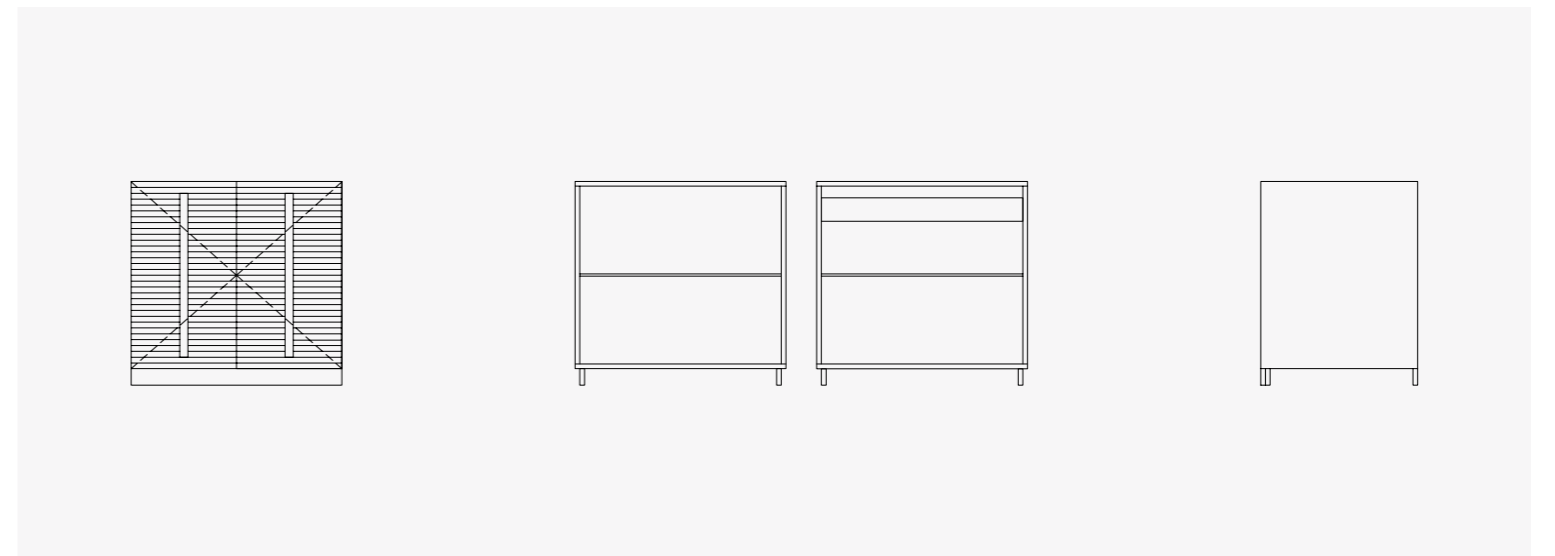

Storage bases 90 - Pull-out drawers - 90x70x87 cm

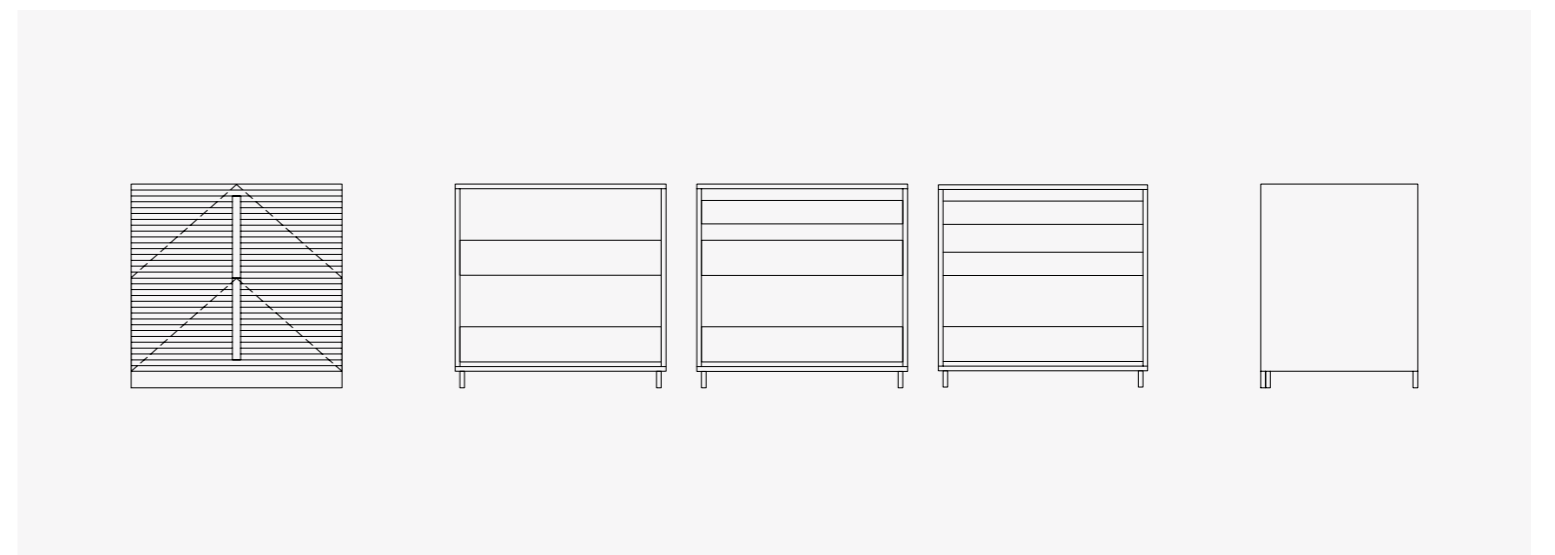

EXTETA

Storage bases 120 - Hinged door - 120×70×87 cm

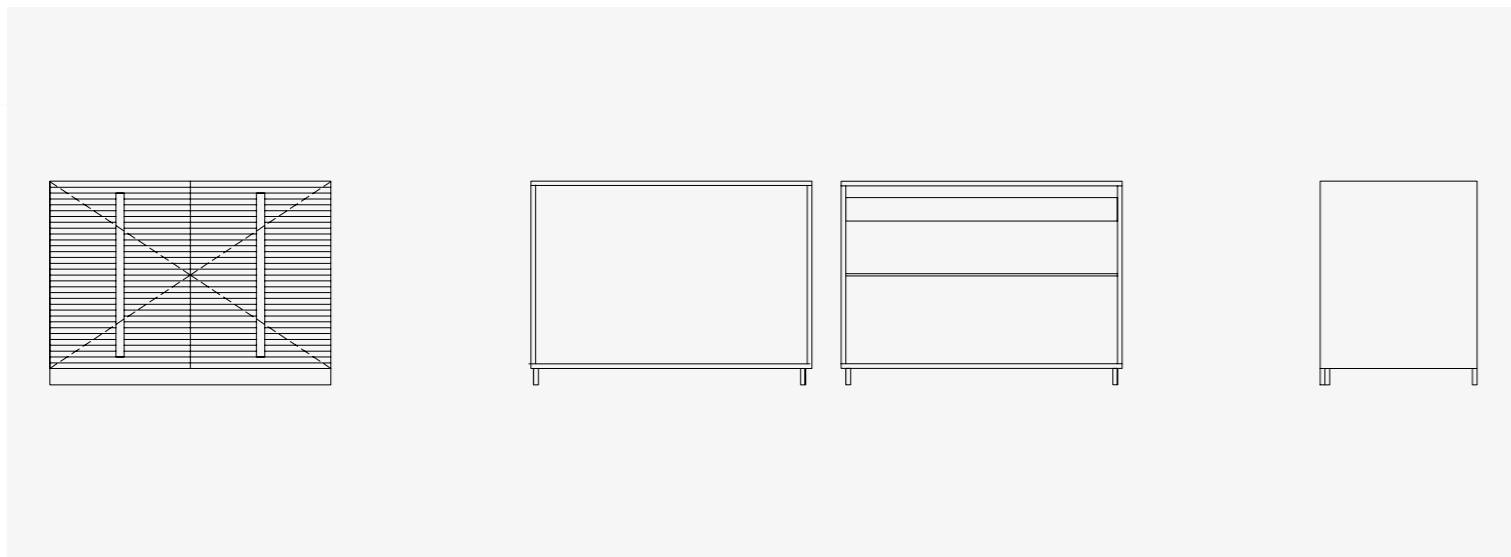

Storage bases 120 - Pull-out drawers - 120×70×87 cm

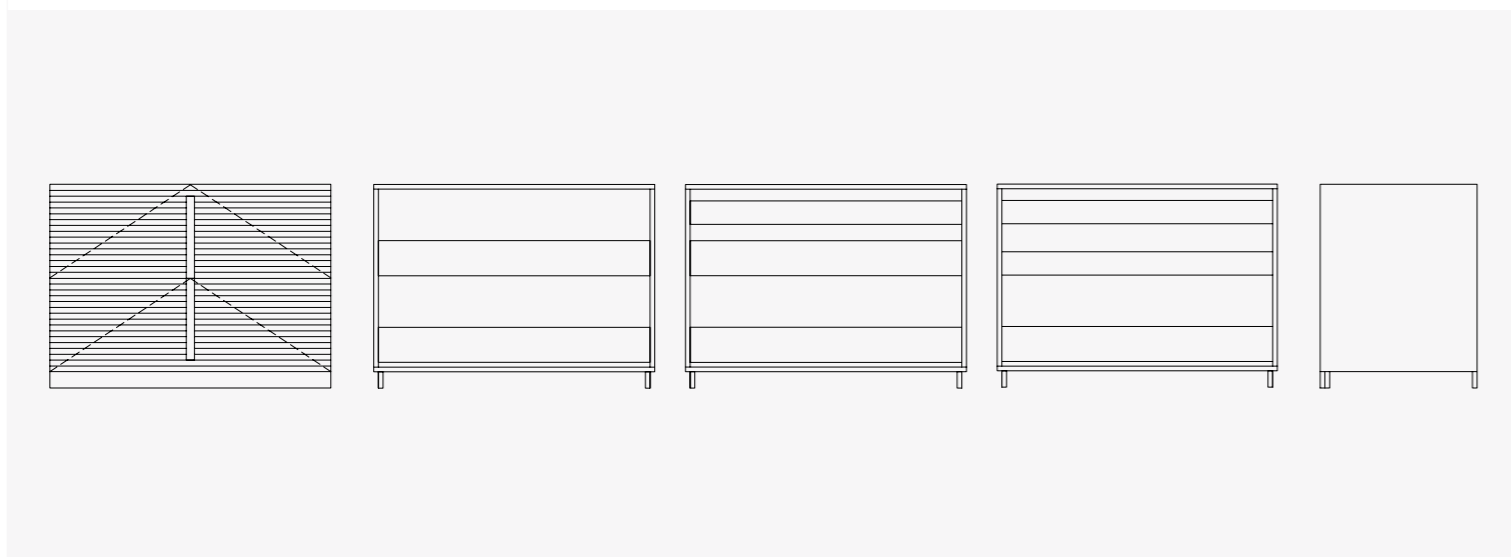

Freestanding - 125×78×67/105 cm

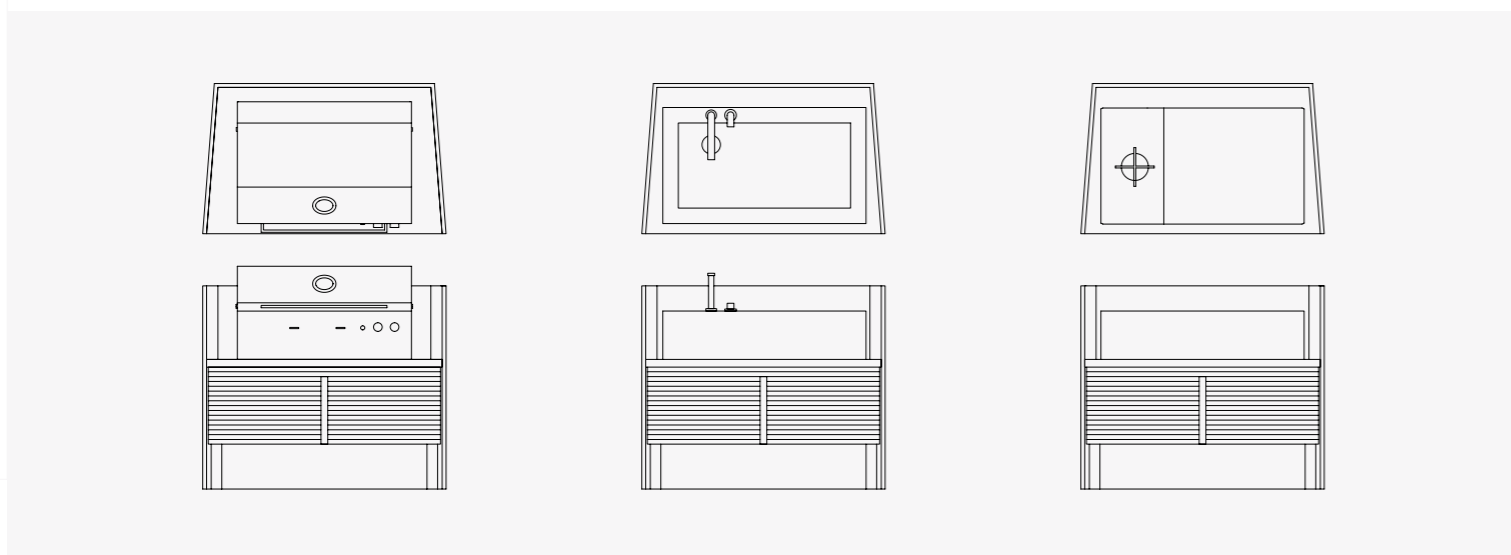

AMALFI KITCHEN

Bench - 342×97×67/125 cm

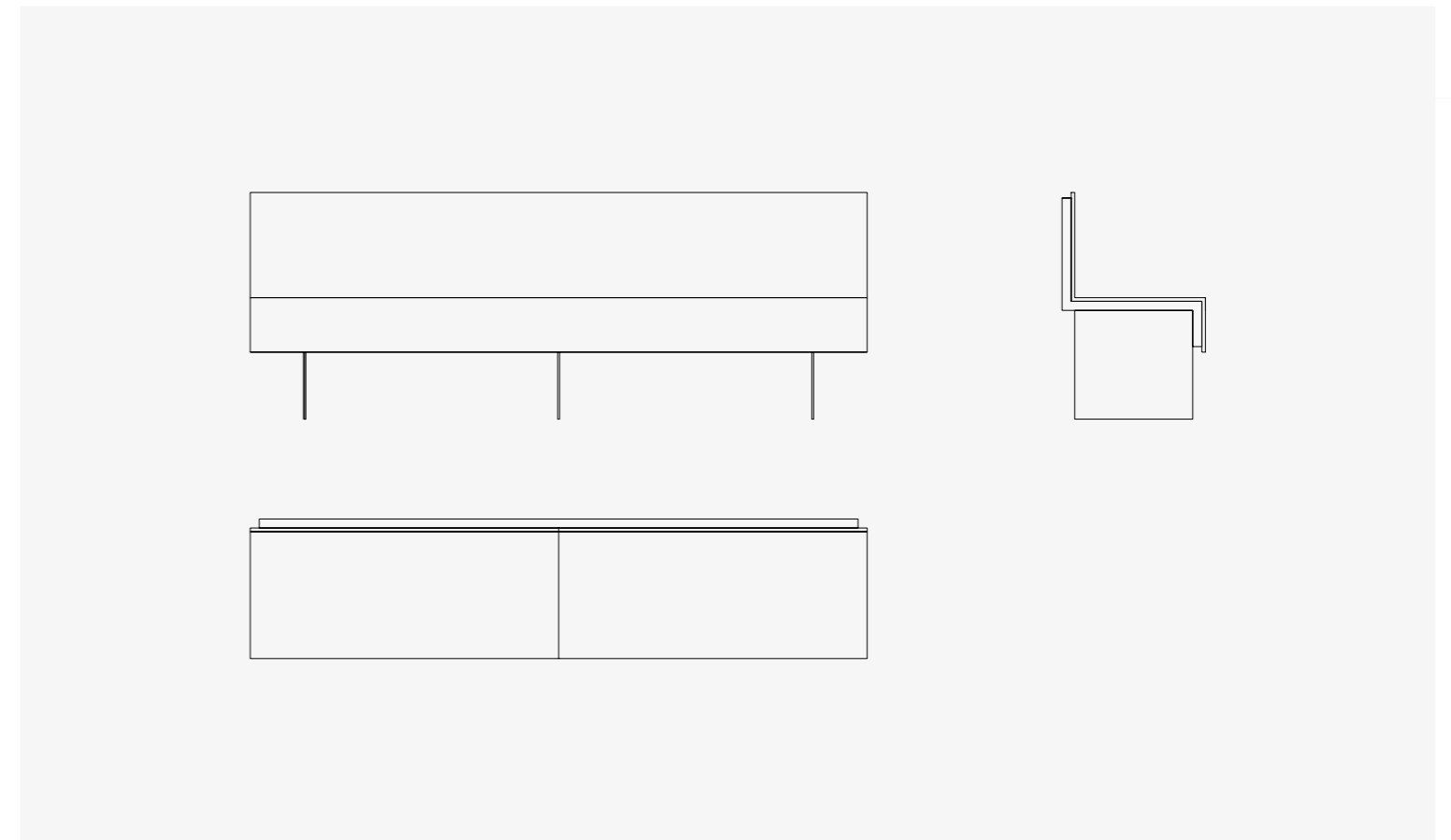

Amalfi Kitchen composition 01 - 342×235 cm

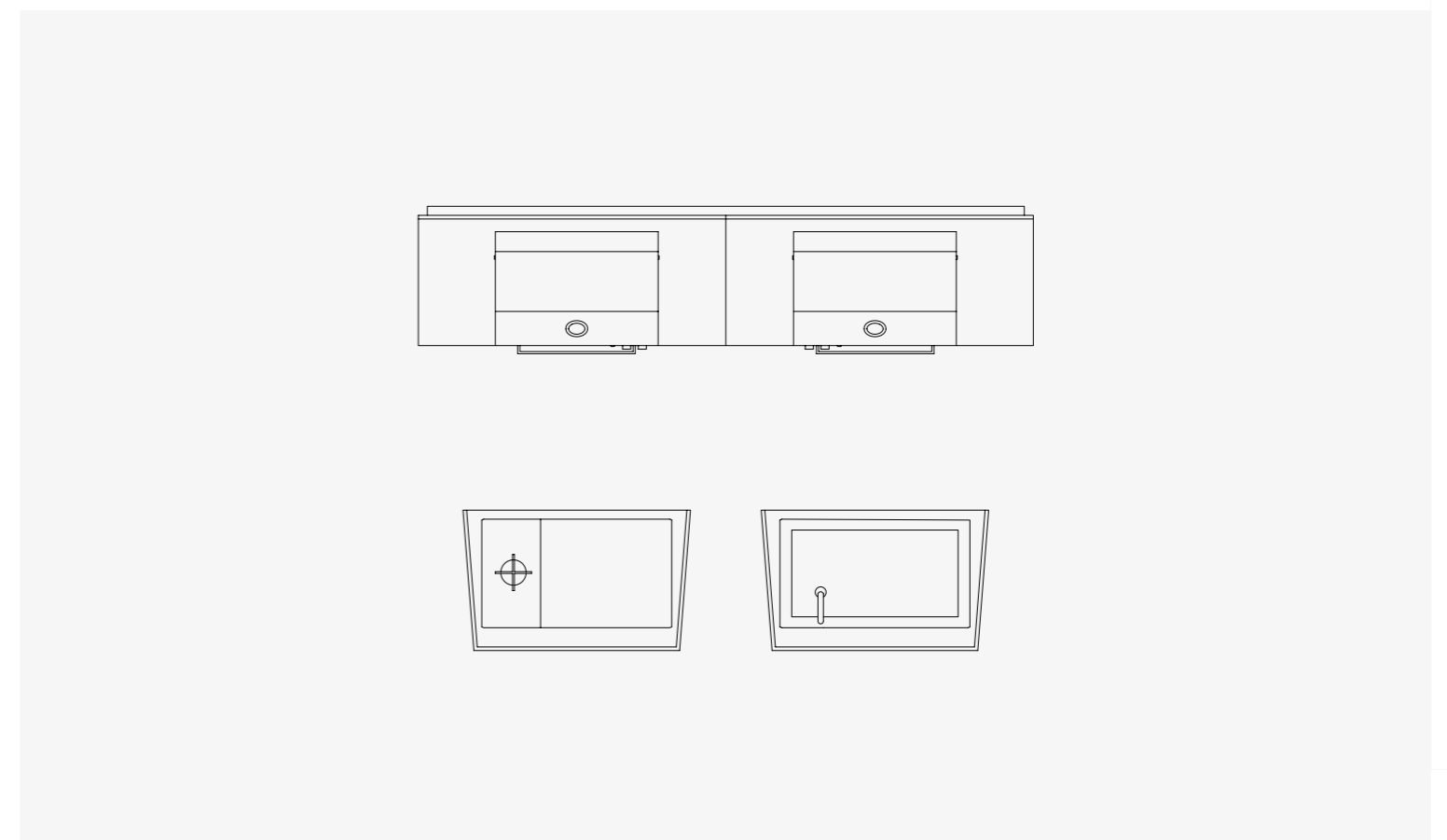

Amalfi Kitchen composition 02 - 360x150 cm

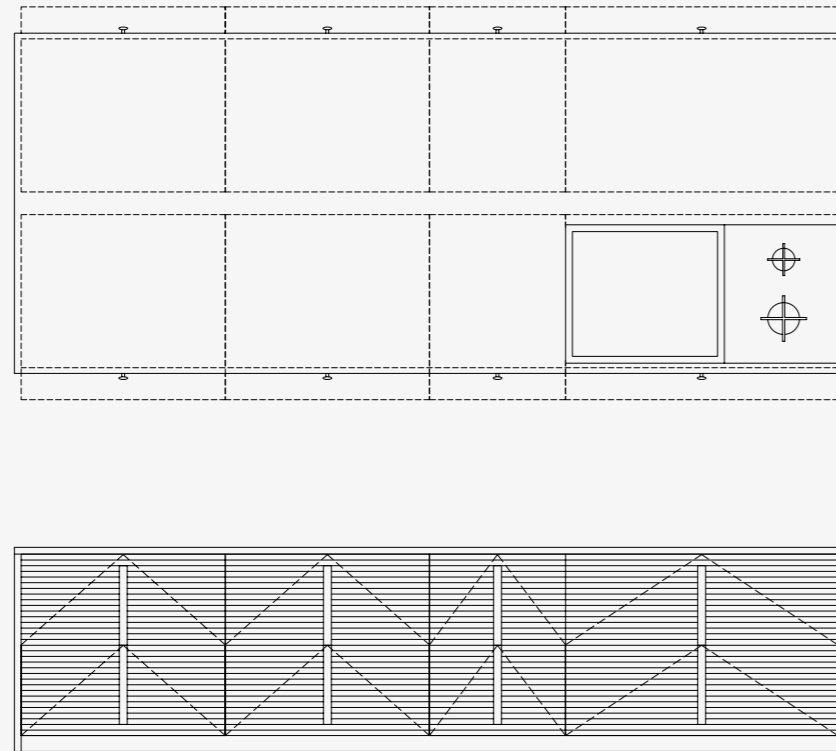

Amalfi Kitchen composition 03 - 360x150 cm

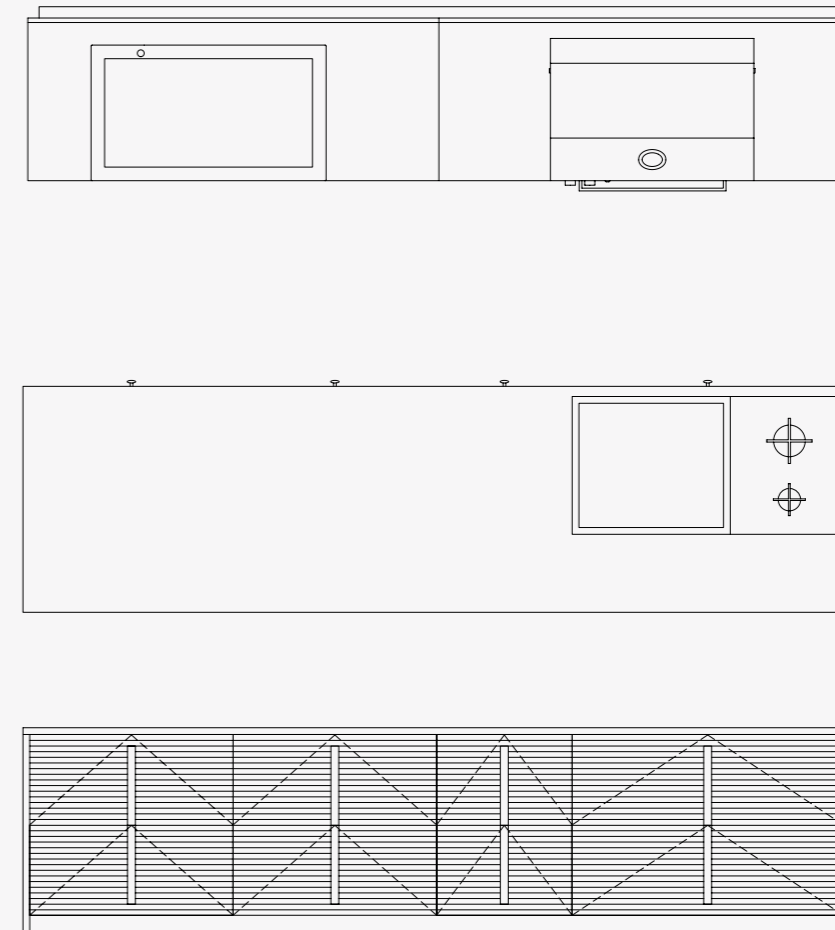

Amalfi Kitchen composition 04 - 484x72 cm

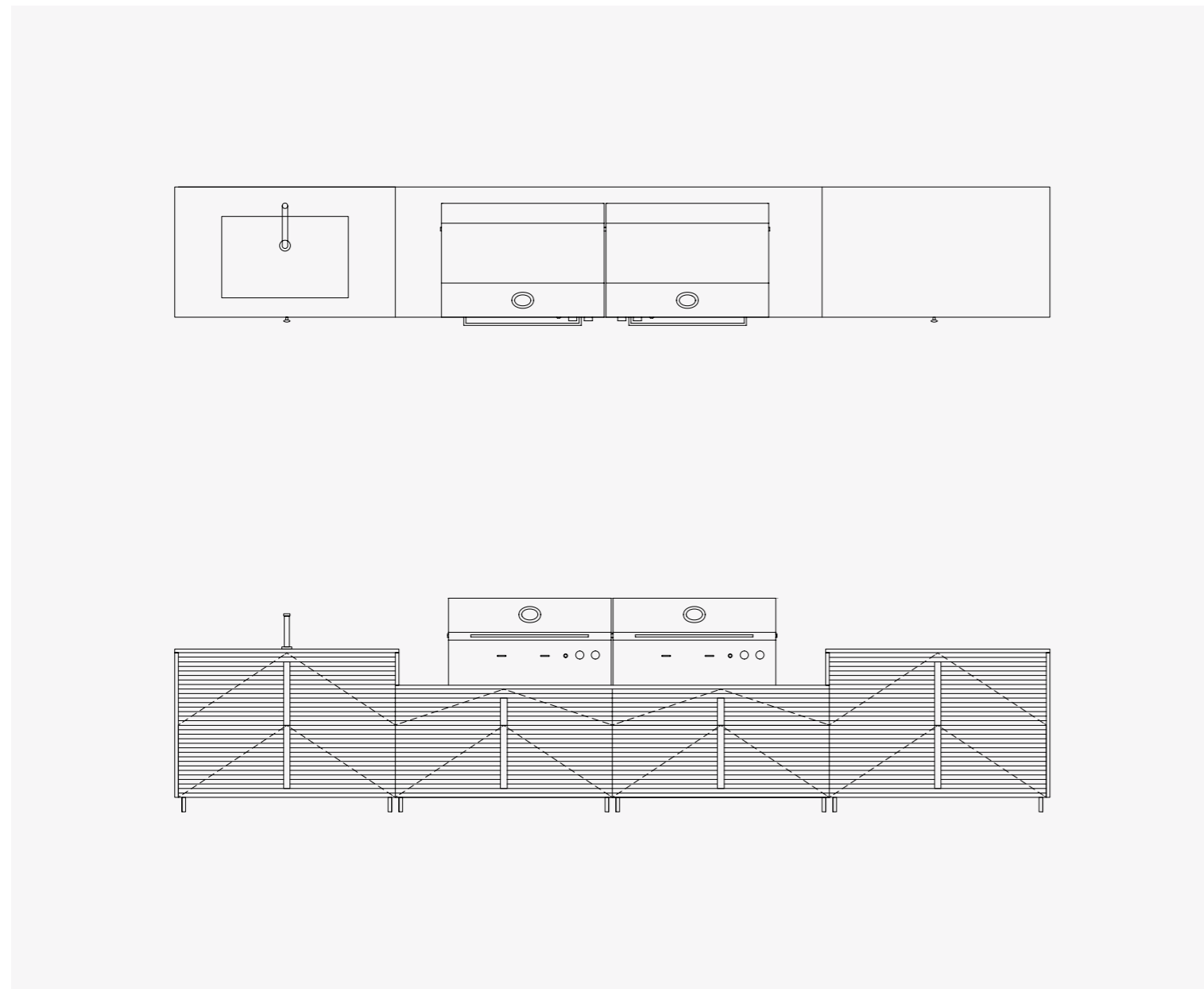

Amalfi Kitchen composition 05 - 443x214 cm

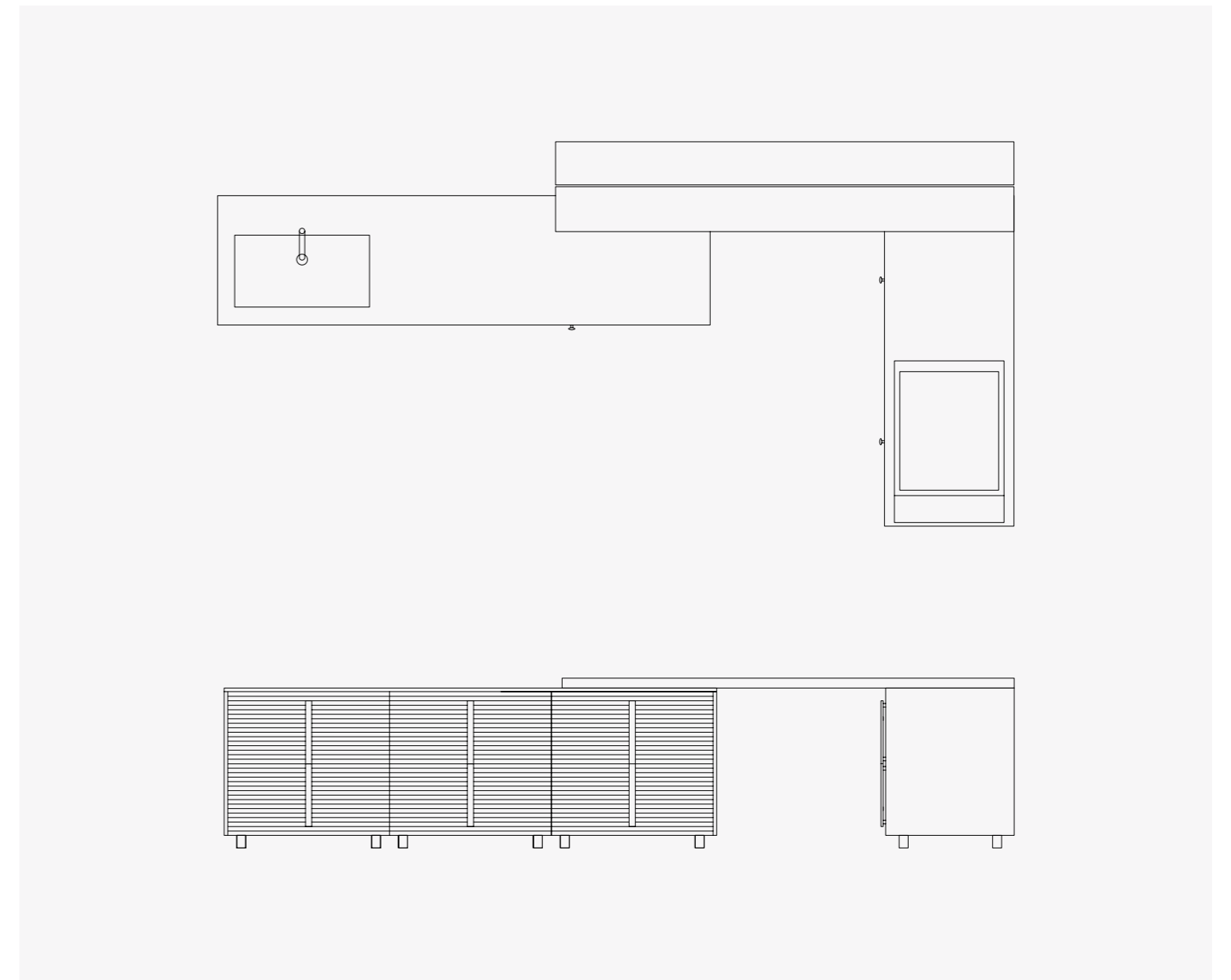

ASTRATTO COFFEE TABLE

Studiopepe



TOP.....enamelled copper
LEGS..... burnished brass

DIMENSIONS
ø45×h45 cm / ø35×h35 cm

P 50

EN Pure and essential, the Astratto table embodies deep artistry. The circular top, hand-enamelled copper, evokes abstract brushstrokes and shifting reflections with the light. Each piece is unique, crafted with meticulous artisanal care.

IT Essenziale e pura, la forma del tavolino Astratto racchiude una forte carica artistica. Il piano circolare, in rame smaltato a mano, richiama pennellate astratte e riflessi cangianti che mutano con la luce. Ogni pezzo è unico, frutto di un lavoro artigianale accurato.



BISCUIT COFFEE TABLE

Massimo Castagna



STRUCTUREmarble / stone

DIMENSIONS
 ø150×h30 cm / 150×150×h30 cm

P 131

EN The Biscuit coffee table echoes the dining table's sculptural lines, single-material composition, and refined details like visible leg joints, softly rounded edges, and unique marble veins selected from rare varieties. A playful and sophisticated homage.

IT Il tavolino Biscuit riprende l'estetica del tavolo omonimo: linee scultoree, monomatericità e dettagli raffinati come le giunture a vista, i bordi arrotondati e le venature uniche del marmo, selezionato tra le varietà più rare. Un omaggio giocoso e sofisticato.

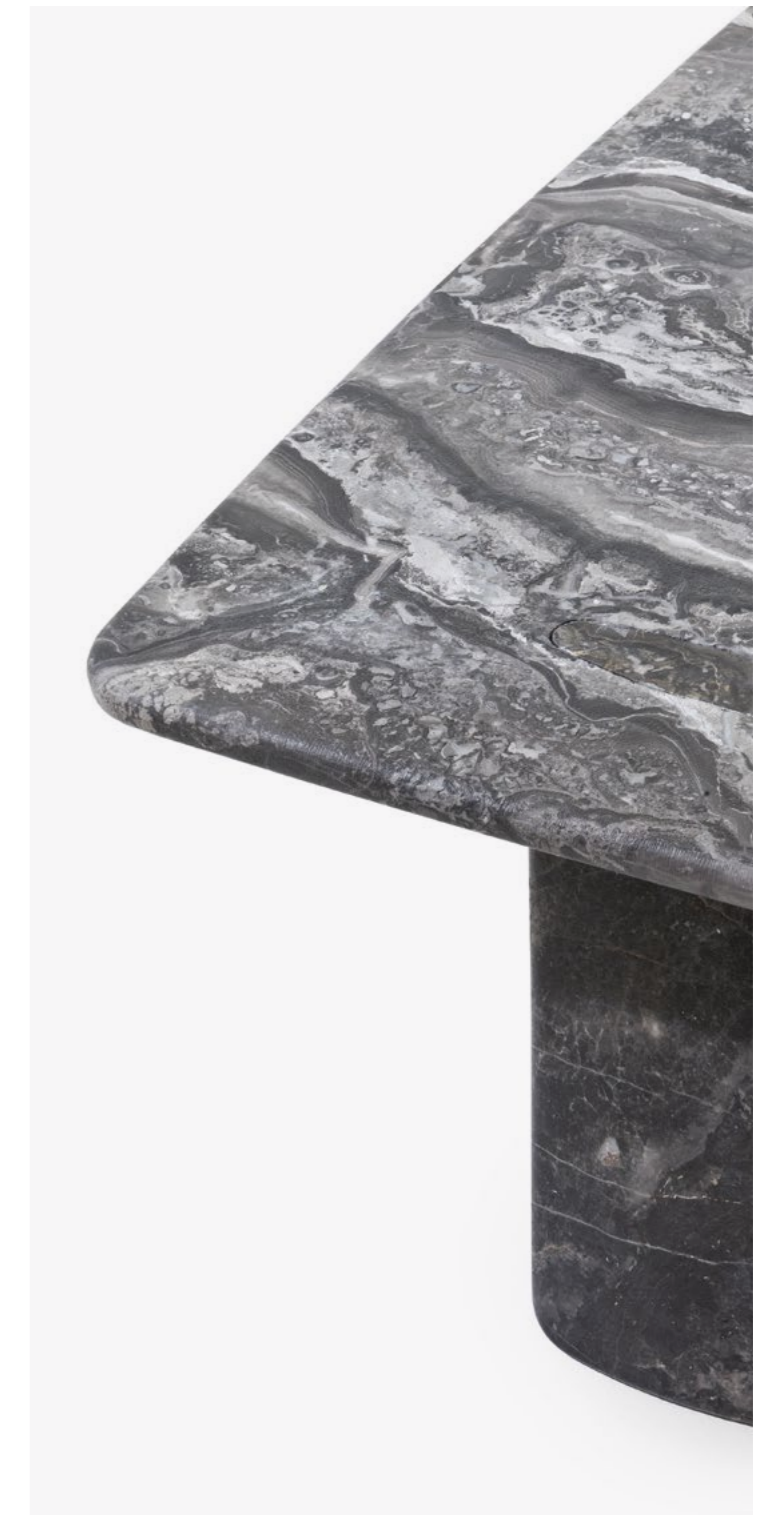

**CAPRERA
SOFA MODULAR**
Massimo Castagna



STRUCTURE sapelli mahogany
HARDWARE stainless steel
PADDING polyurethane
TOP INTERNAL LINING Waterproof and breathable fabrics
EXTERNAL LINING fabric or leather
FEET sapelli mahogany, stainless steel 316

DIMENSIONS

See following pages
 /vedi le pagine seguenti

PP 44-45, 48-51, 53-55, 57, 128-131

EN Caprera is a modular sofa designed as an archipelago of comfort: composable, customizable, and evolving elements. Airy, longitudinal design, slightly suspended, complemented by low, adjustable backs for a light, relaxed aesthetic.

IT Caprera è un divano modulare pensato come un arcipelago di comfort: elementi componibili, personalizzabili e in evoluzione. Dal design aereo e longitudinale, è sospeso da terra e completato da schienali bassi e regolabili, per un'estetica leggera e rilassata.



TECHNICAL DATA

End element (L & R) - 95×95×68 cm

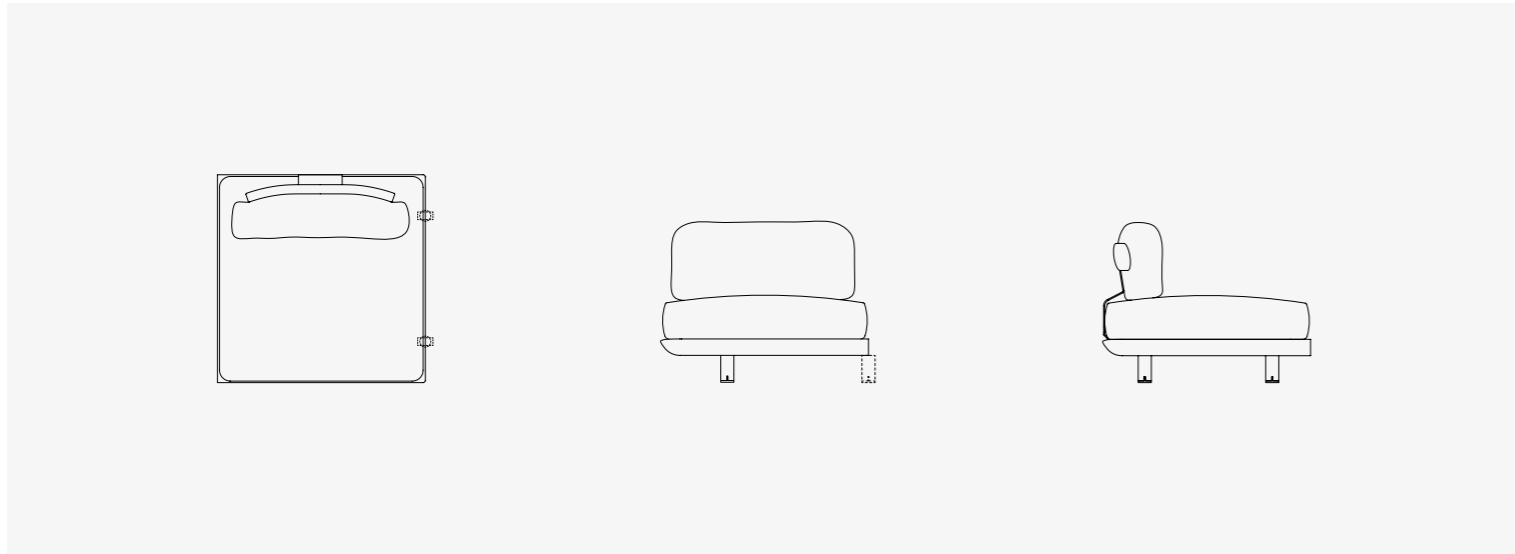

Angular (L & R) - 95×95×68 cm

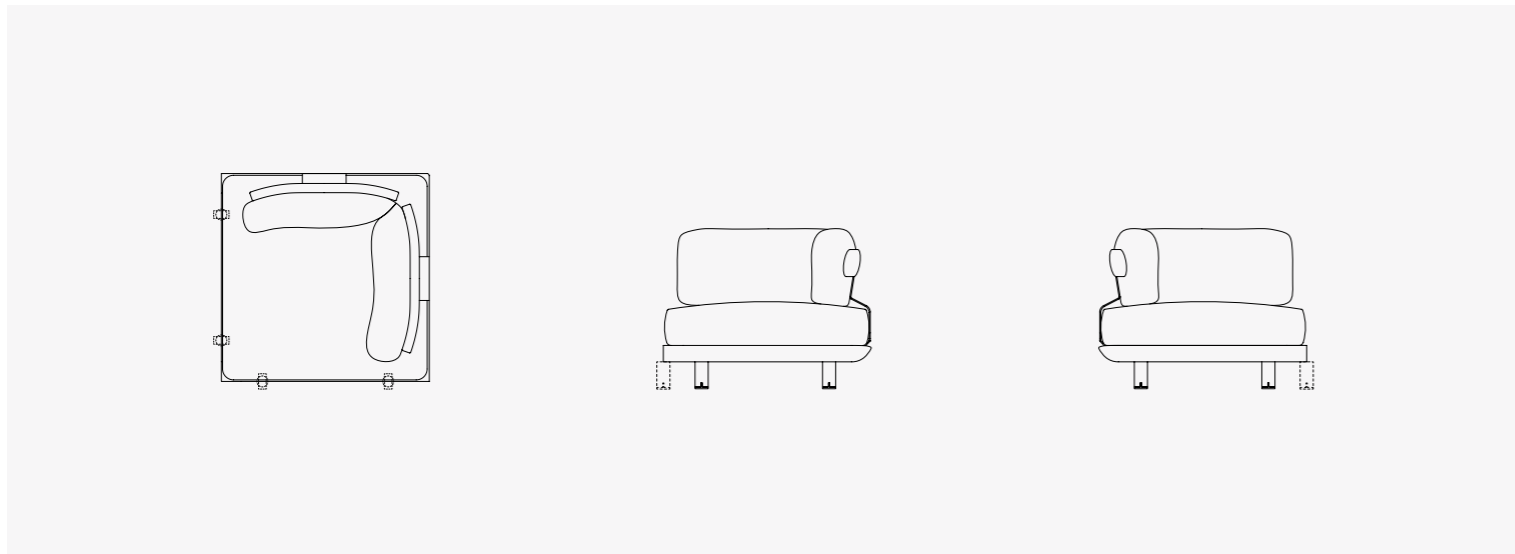

Central - 95×95×68 cm

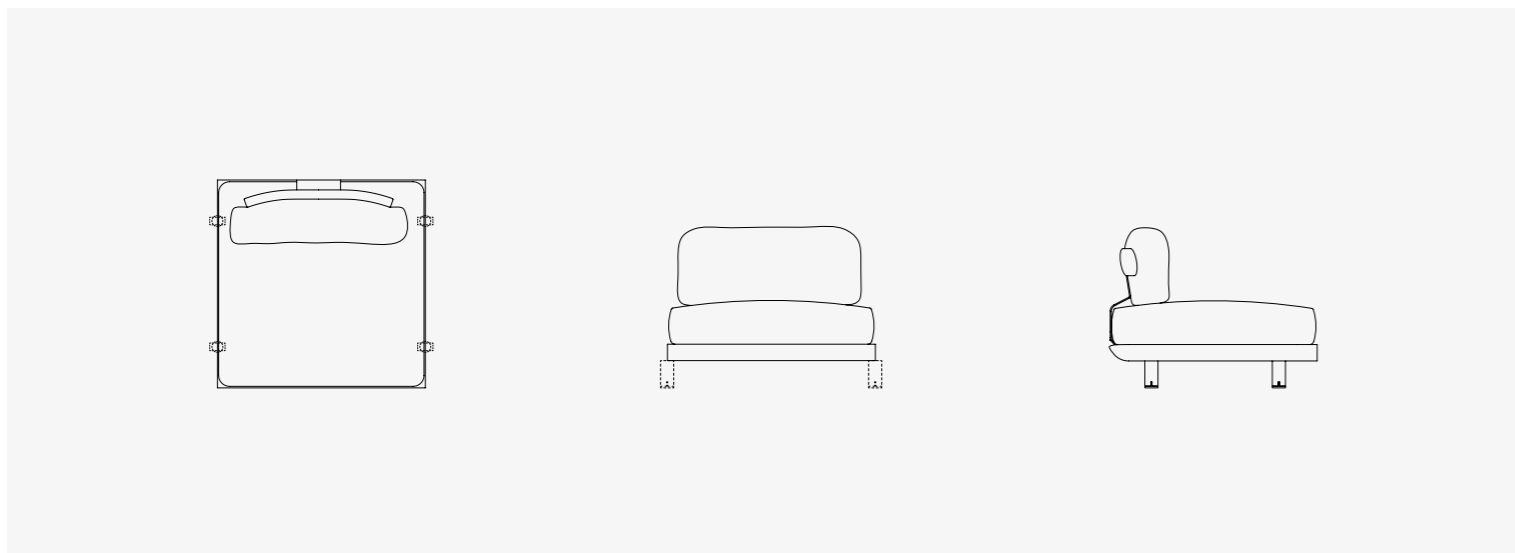

Pouf end element - 95×95×40 cm

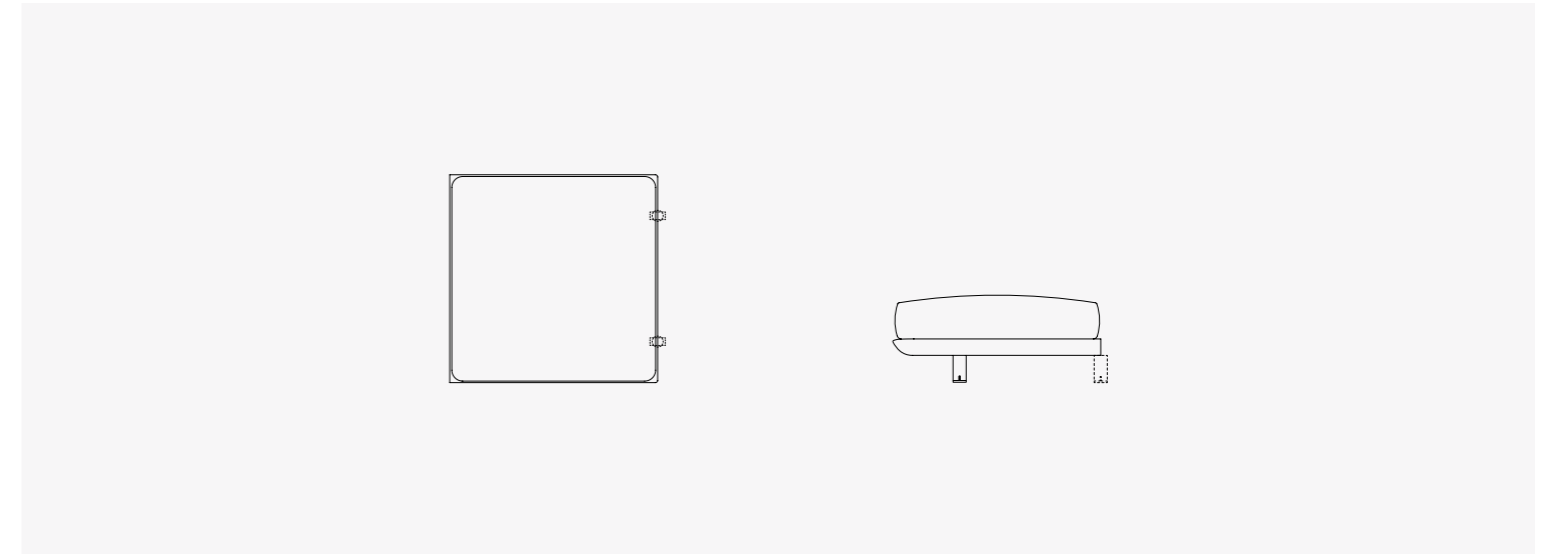

Pouf angular - 95×95×40 cm

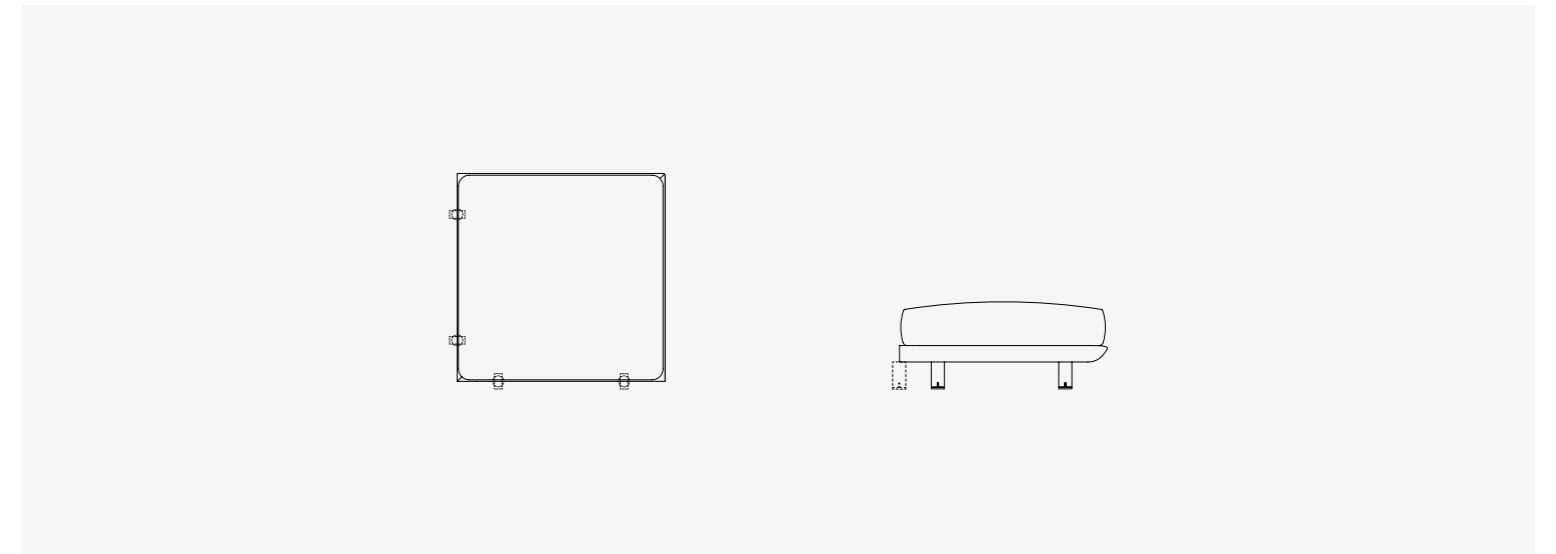

Pouf central - 95×95×40 cm

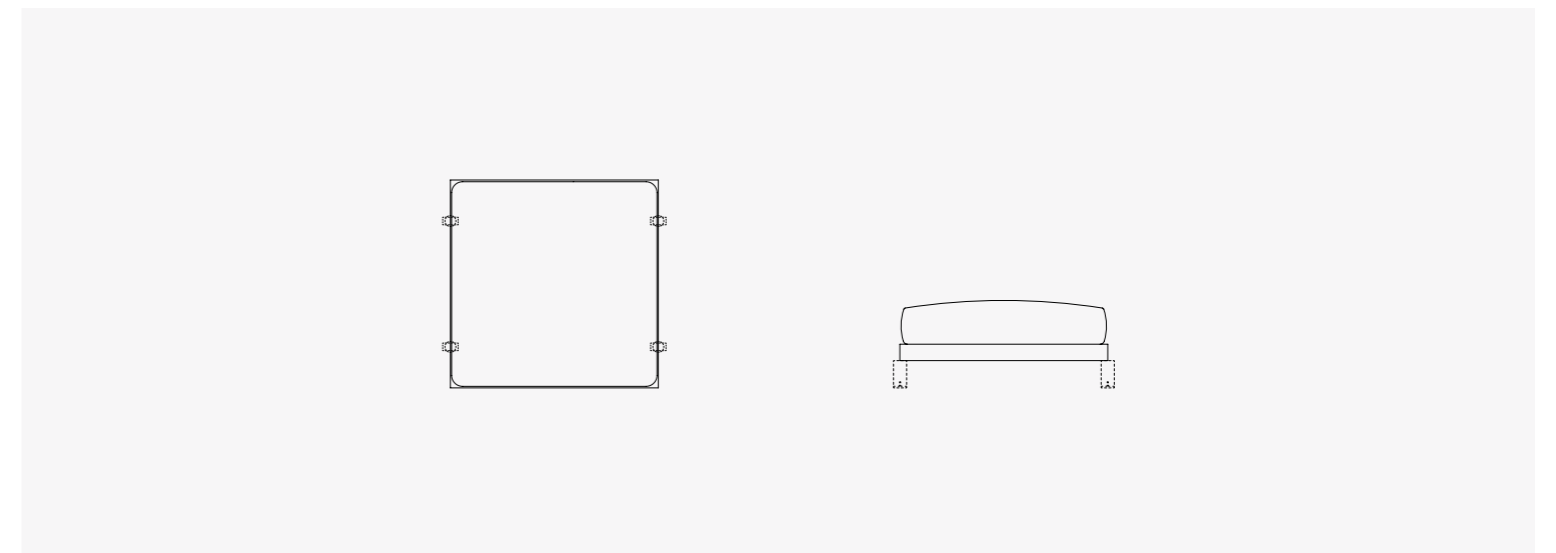

EXTETA

Island with weighted backrest - 160×150×68 cm

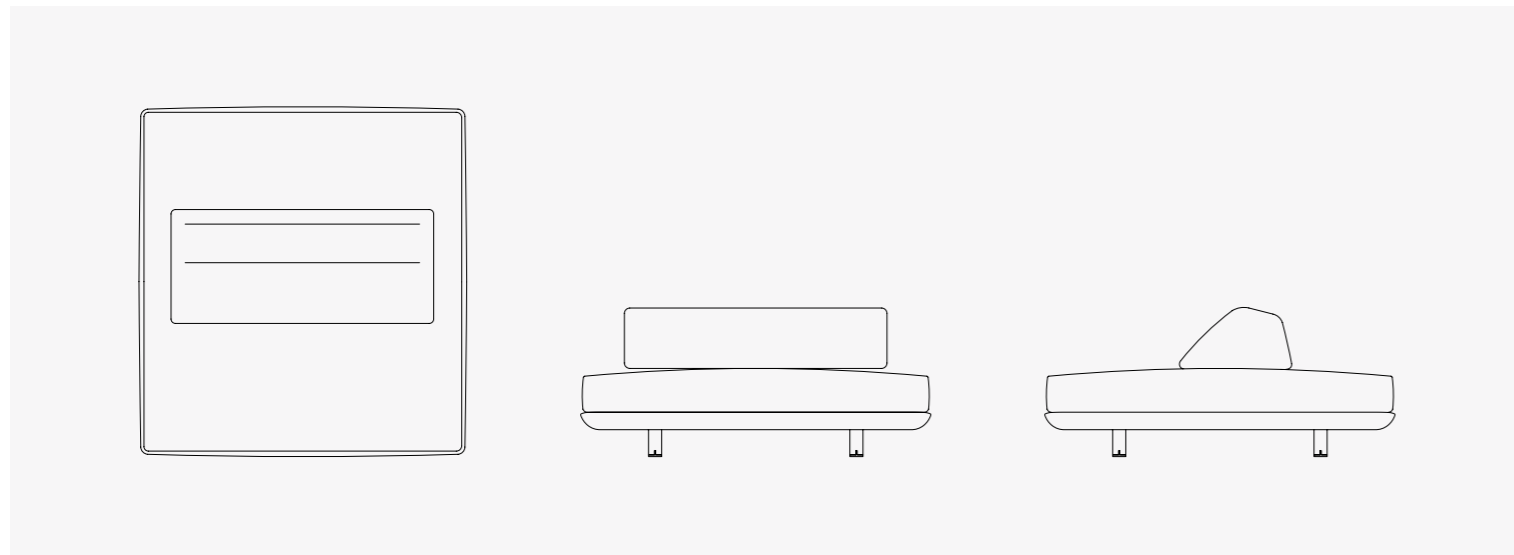

Island with standard fixed backrest (L & R) - 160×150×68 cm

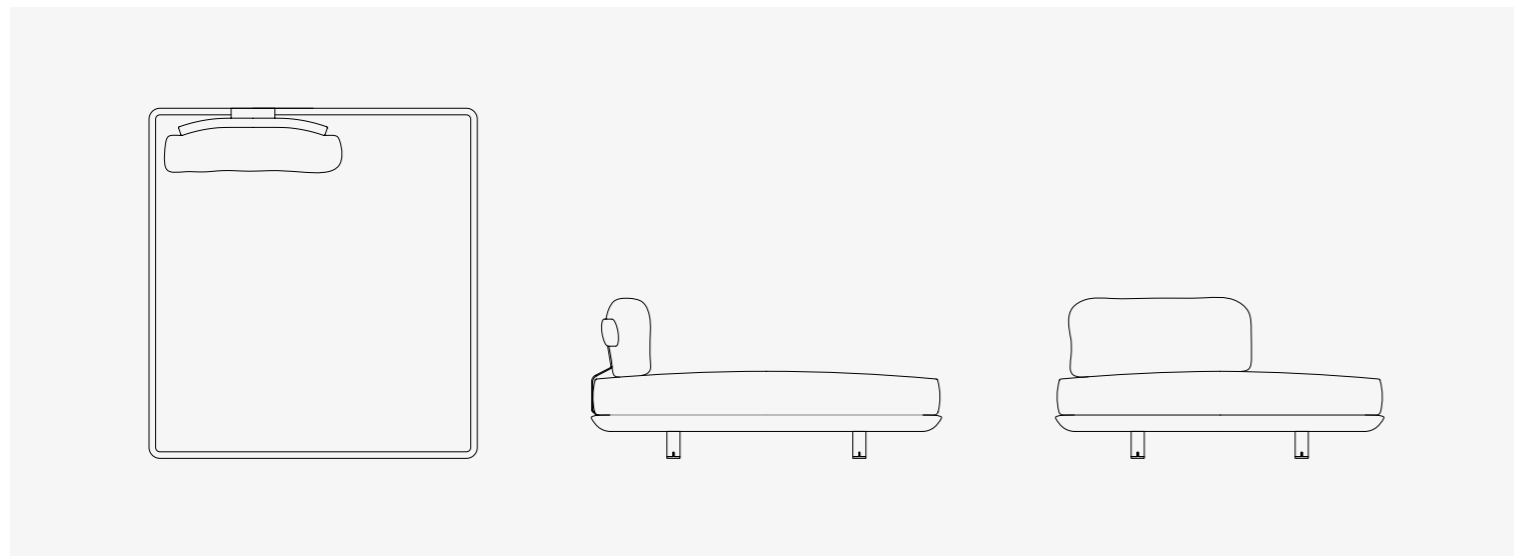

Wooden armrest (L & R) - 62×24×26 cm

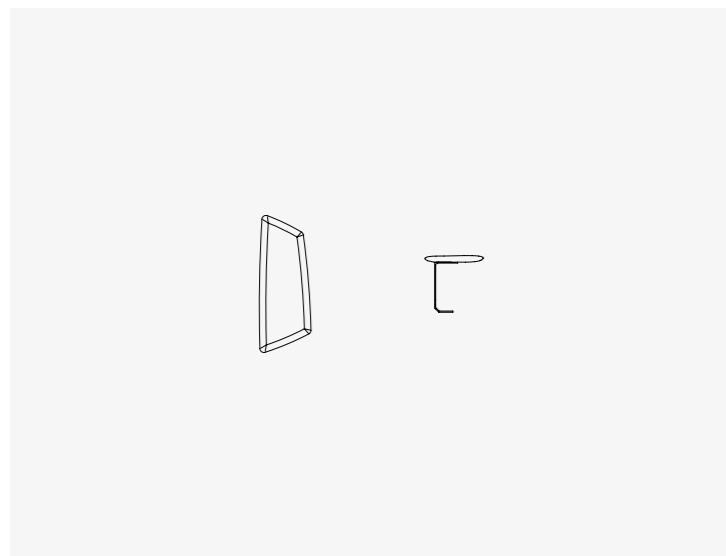

CAPRERA SOFA MODULAR

Caprera composition 01 - 620×430 cm

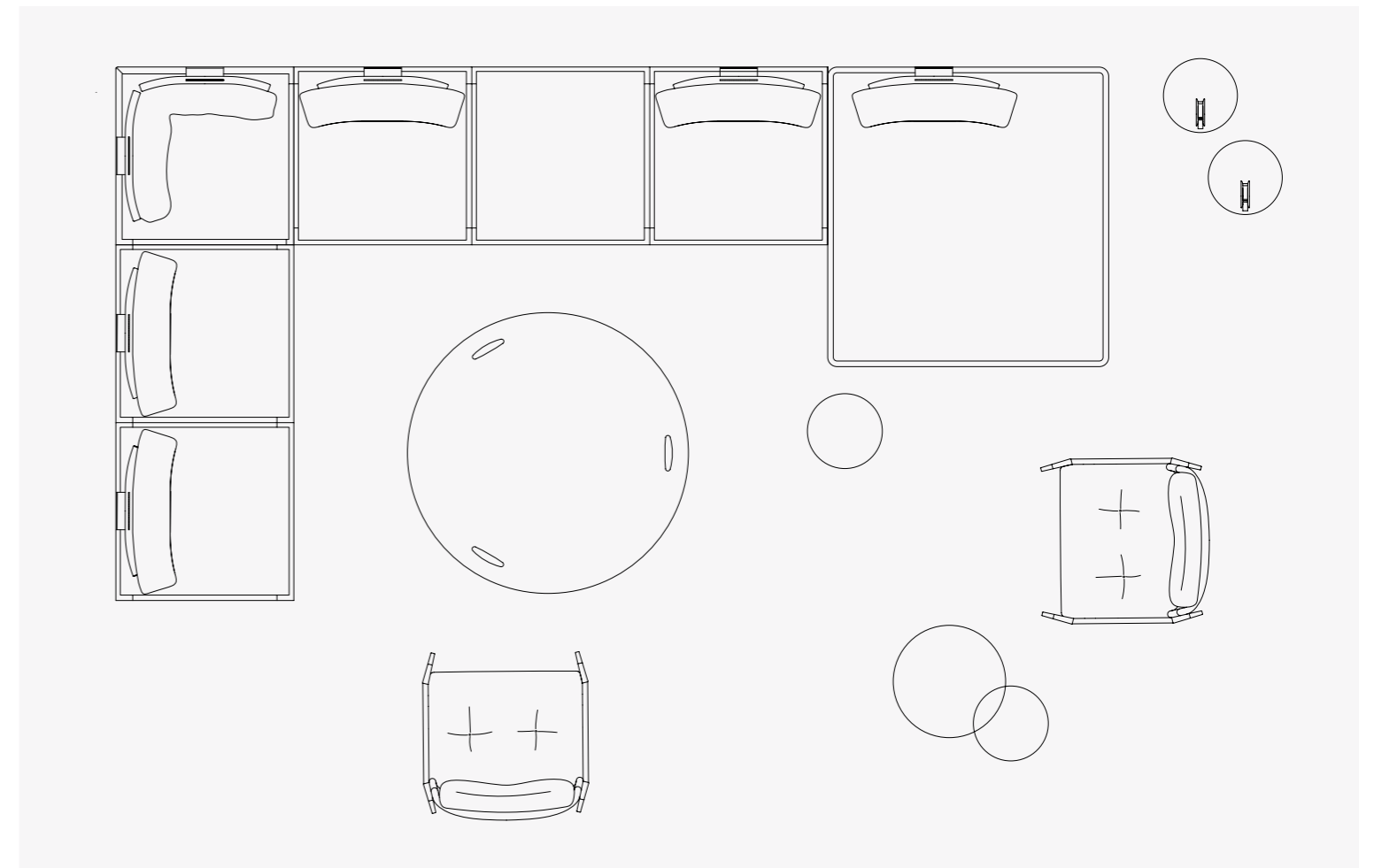

Caprera composition 02 - 300×320 cm

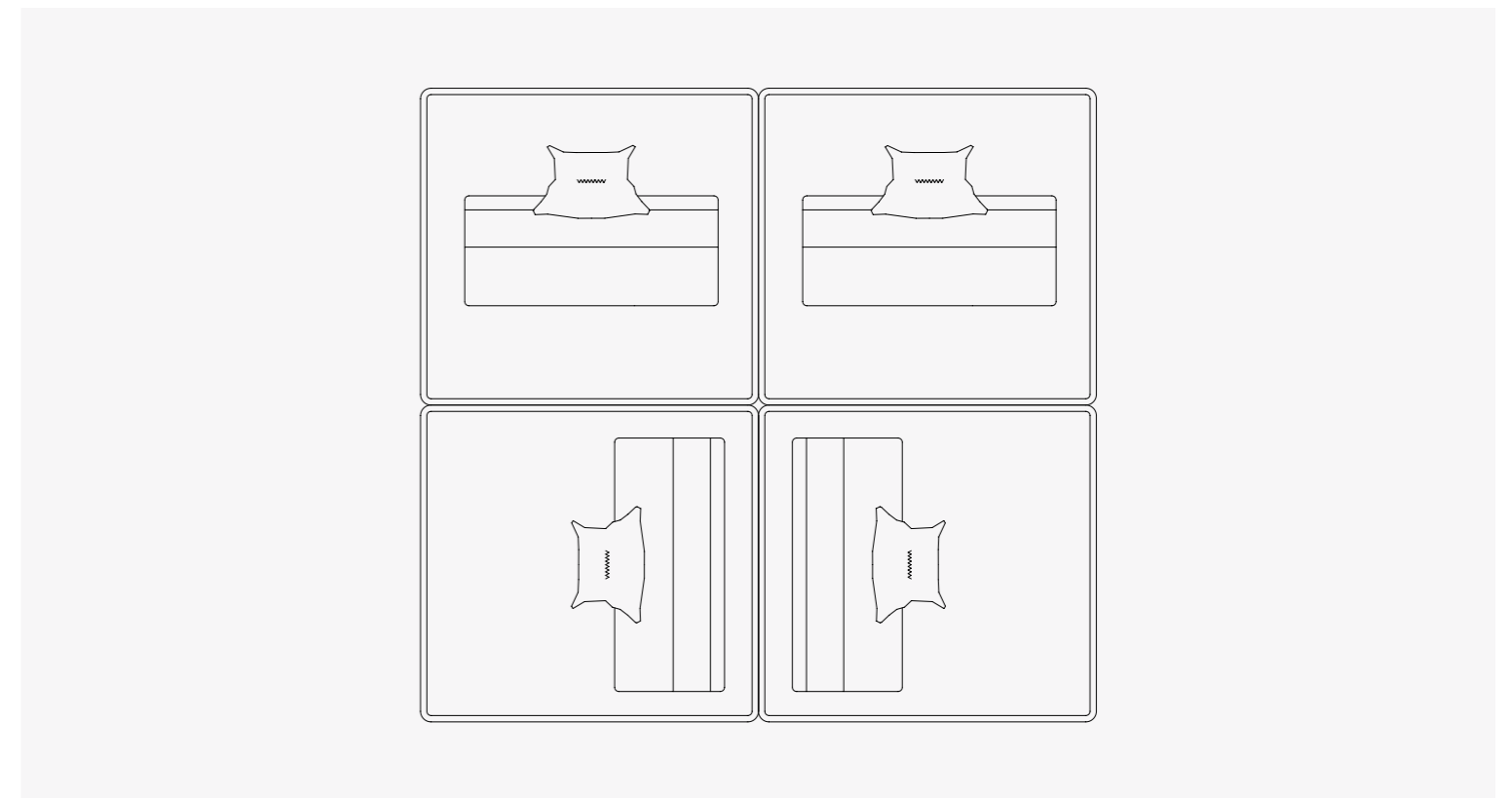

**EXTETA X RIVA
ARMCHAIR**
Massimo Castagna



STRUCTURE sapelli mahogany, stainless steel 316
INTERNAL LINING..... waterproof and breathable fabrics
EXTERNAL LINING..... fabric or leather
FEET..... stainless steel 316, PVC

DIMENSIONS
71x73x76 cm

PP 10, 21, 101-103, 107

EN The nautical aesthetic is reflected in the use of noble materials, such as stainless steel and hand-finished mahogany, as well as in the light, tapered lines that project towards the horizon. With a touch of timeless style, this deep and spacious seat is designed to enhance any lounge area.

IT L'estetica nautica si traduce in materiali nobili come l'acciaio inox e il mogano rifinito a mano, e nelle linee leggere, affusolate, proiettate all'orizzonte. Una seduta, ampia e profonda, pensata per arricchire ambienti lounge con un tocco di stile senza tempo.

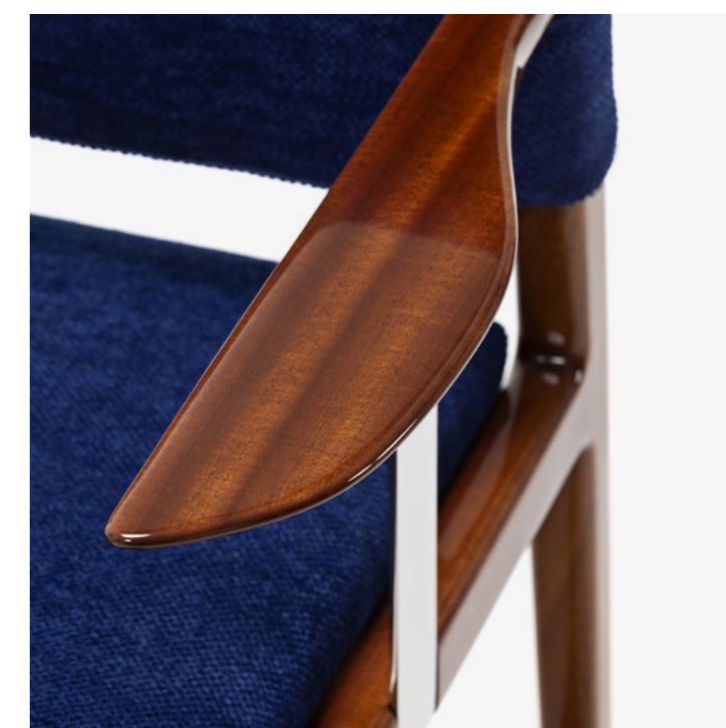
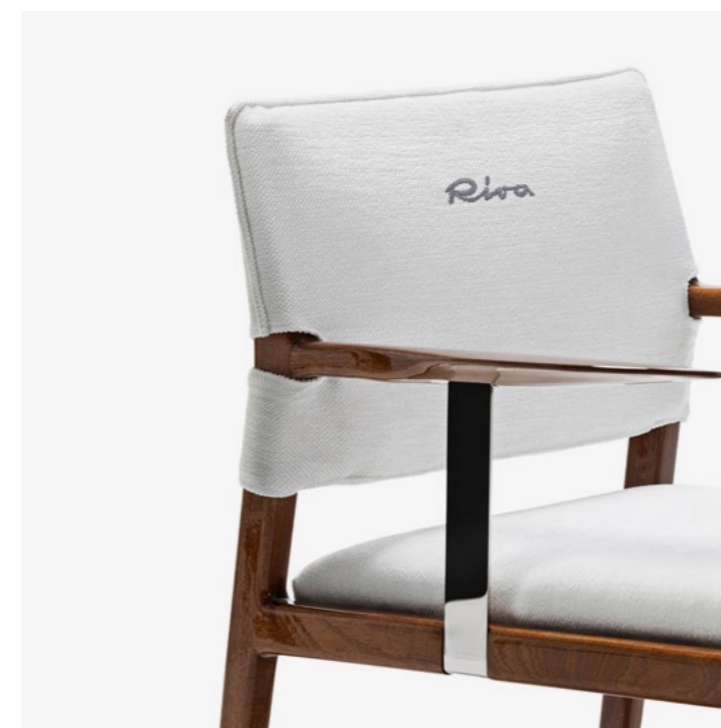

EXTETA X RIVA CHAIR

Massimo Castagna



STRUCTURE sapelli mahogany, stainless steel 316
INTERNAL LINING waterproof and breathable fabrics
EXTERNAL LINING fabric or leather
FEET stainless steel 316, PVC

DIMENSIONS
66x61x82 cm

PP 10, 94-95, 97

EN This chair is set to become an iconic piece of furniture. The result of a partnership between two Italian companies renowned for their excellence, it embodies combined expertise that is echoed in its elegant, dynamic lines, premium, high-performance, durable materials and handcrafted finishes.

IT Questo arredo è già destinato a diventare un'icona. Frutto della collaborazione tra due eccellenze italiane, questa sedia racchiude un savoir-faire condiviso che si riflette nelle linee eleganti e dinamiche, nei materiali pregiati, performanti e resistenti, e nelle finiture eseguite a mano.

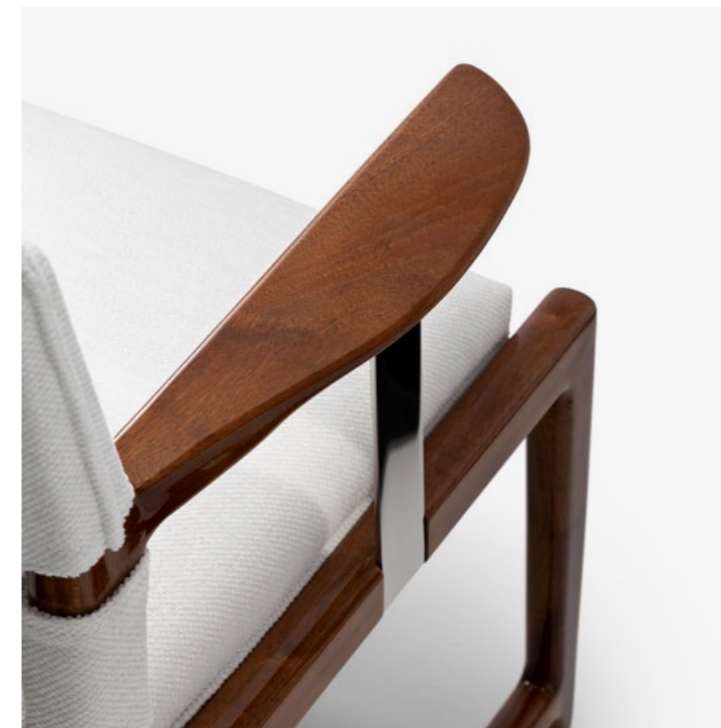

EXTETA X RIVA COFFEE TABLE

Massimo Castagna



TOP.....sapelli mahogany
LEGS.....polished stainless steel 316

DIMENSIONS
100x100x45 cm

PP 10, 100-102, 104-107

EN A smaller-scale version of the dining table from the collection. The hand-finished mahogany top calls to mind the deck of a yacht, while the base – a stainless steel column – accentuates its lightweight appearance.

IT Il tavolino Exteta x Riva replica su scala ridotta i canoni compositivi del tavolo da pranzo della collezione. Il piano in mogano, rifinito a mano, richiama il ponte di uno yacht, mentre la base – una colonna d'acciaio inox – ne esalta la leggerezza.

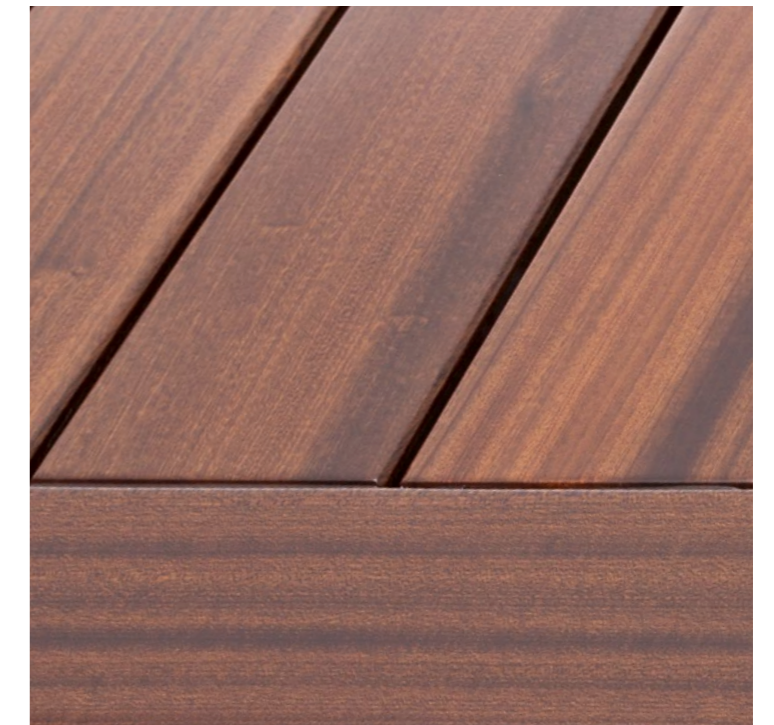

EXTETA X RIVA DINING TABLE

Massimo Castagna



TOP.....sapelli mahogany
LEGS.....polished stainless steel 316

DIMENSIONS
150x150xh75 cm

PP 10, 94-97

EN The table designed by Exteta and Riva from the collection reinterprets the concept and design of a classic yacht deck: an outdoor living space that brings you into close contact with natural materials and the surrounding landscape.

IT Il tavolo della collezione firmata Exteta e Riva reinterpreta nel concept e nel design il ponte di un classico yacht: uno spazio da vivere all'aria aperta, a stretto contatto con la naturalità dei materiali e del paesaggio.

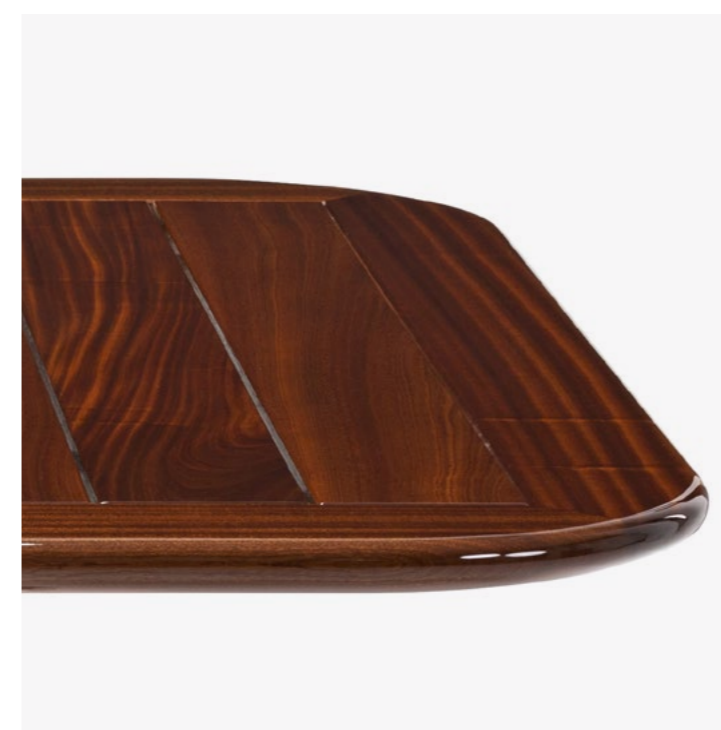

EXTETA X RIVA LAMP

Massimo Castagna



STRUCTURE stainless steel 316

LED 2.5 W, 190/200 lm/W

DIMENSIONS
14×16×33 cm

PP 9, 21, 24-25,
94-97, 101-102, 107

EN The Exteta x Riva Lamp was conceived as a small, wireless and rechargeable table sculpture made of polished stainless steel with a touch sensor for switching on and off.

IT Exteta x Riva Lamp: una piccola scultura da tavolo realizzata in acciaio inox lucidato, wireless e ricaricabile, dotata di sensore touch per un'accensione intuitiva.



EXTETA X RIVA LOUNGE TABLE

Massimo Castagna



TOP.....sapelli mahogany
LEGS.....polished stainless steel 316

DIMENSIONS
100×100×65 cm

P 21

EN Measuring 65 centimetres in height, this table aligns with the contemporary low dining trend, offering a relaxed and convivial experience suitable for any time of day.

IT Grazie alla sua peculiare altezza di 65 centimetri, questo tavolo abbraccia la tendenza contemporanea del low dining, creando così un'esperienza più rilassata e conviviale, adatta a ogni momento della giornata.



EXTETA X RIVA LOUNGE CHAIR

Massimo Castagna



STRUCTUREstainless steel, aluminium
PADDING variable-density high resilience polyurethane comfort foams
INTERNAL LINING..... waterproof and breathable fabrics
EXTERNAL LINING..... fabric or leather fabric
FEET..... aluminium

DIMENSIONS
108x87x79 cm

EN Taking inspiration from the sofa in the collection, the Lounge Chair reinterprets its enveloping, slender design in a more compact version. In the padded armrest version, the side contour follows the shape of the silhouette, while in the mahogany version, the volume appears lighter and airier.

IT La Lounge Chair reinterpreta in chiave compatta il divano della collezione. Il concept si esprime con forza nei braccioli: nella versione imbottita, un profilo laterale ne tratteggia la silhouette; nella variante in mogano, il volume si fa più leggero e arioso.

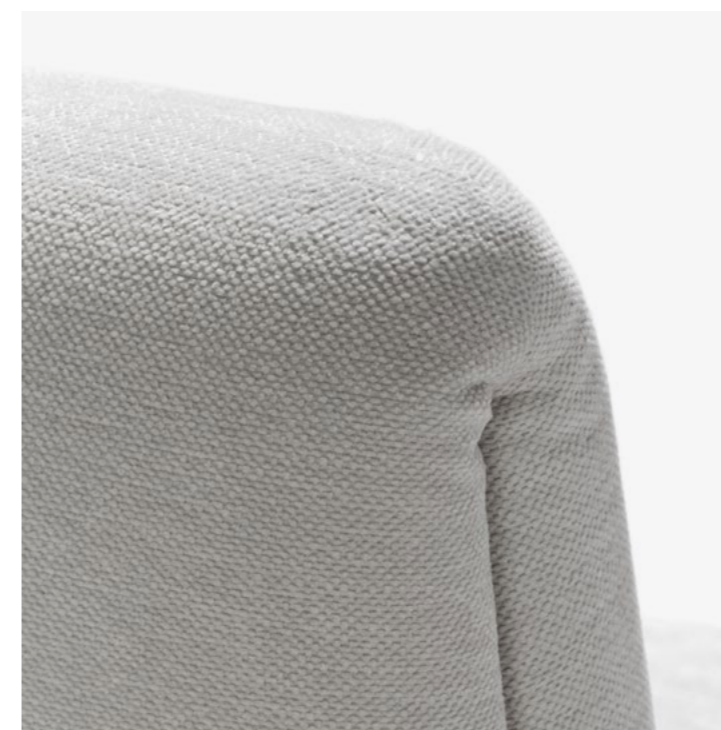

**EXTETA X RIVA
LOUNGE CHAIR WITH
WOODEN ARMRESTS**

Massimo Castagna



STRUCTUREstainless steel, aluminium
PADDING variable-density high resilience polyurethane comfort foams
INTERNAL LINING..... waterproof and breathable fabrics
EXTERNAL LINING..... fabric or leather fabric
FEET..... aluminium

DIMENSIONS
104x87x79 cm

PP 100, 104-107

EN Taking inspiration from the sofa in the collection, the Lounge Chair reinterprets its enveloping, slender design in a more compact version. In the padded armrest version, the side contour follows the shape of the silhouette, while in the mahogany version, the volume appears lighter and airier.

IT La Lounge Chair reinterpreta in chiave compatta il divano della collezione. Il concept si esprime con forza nei braccioli: nella versione imbottita, un profilo laterale ne tratteggia la silhouette; nella variante in mogano, il volume si fa più leggero e arioso.

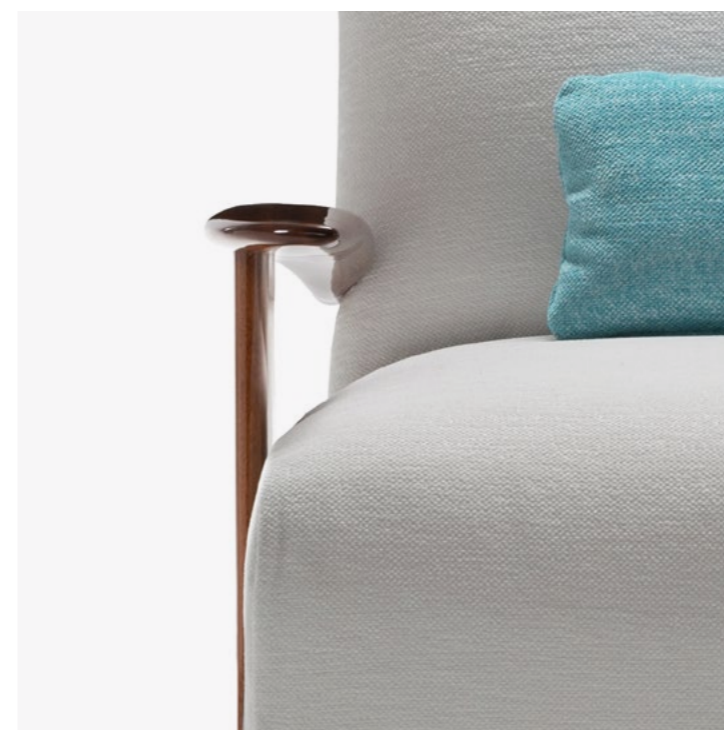

EXTETA X RIVA
SOFA
Massimo Castagna



STRUCTUREstainless steel, aluminium
PADDING variable-density high resilience polyurethane comfort foams
INTERNAL LINING..... waterproof and breathable fabrics
EXTERNAL LINING..... fabric or leather fabric
FEET..... aluminium

DIMENSIONS
See following pages
/vedi le pagine seguenti

PP 24, 100-101, 104-107

EN Characterized by ample proportions and meticulous attention to detail, from the padded or mahogany armrests to the selection of materials that are specifically designed for outdoor use, up to modules that can be combined to create a system where you can relax, let yourself be enveloped.

IT Una visione contemporanea del comfort, accentuata da volumi generosi e dettagli accurati: dai braccioli imbottiti o in mogano alla scelta di materiali studiati per resistere all'aperto. Fino alla componibilità modulare che crea un sistema in cui rilassarsi e lasciarsi avvolgere.



**EXTETA X RIVA
SOFA WITH
WOODEN ARMRESTS**

Massimo Castagna



STRUCTUREstainless steel, aluminium
PADDING variable-density high resilience polyurethane comfort foams
INTERNAL LINING..... waterproof and breathable fabrics
EXTERNAL LINING..... fabric or leather fabric
FEET..... aluminium

DIMENSIONS

See following pages
 /vedi le pagine seguenti

PP 9, 101, 102, 106-107

EN Characterized by ample proportions and meticulous attention to detail, from the padded or mahogany armrests to the selection of materials that are specifically designed for outdoor use, up to modules that can be combined to create a system where you can relax, let yourself be enveloped.

IT Una visione contemporanea del comfort, accentuata da volumi generosi e dettagli accurati: dai braccioli imbottiti o in mogano alla scelta di materiali studiati per resistere all'aperto. Fino alla componibilità modulare che crea un sistema in cui rilassarsi e lasciarsi avvolgere.



EXTETA

TECHNICAL DATA

Central - 90×95×84 cm

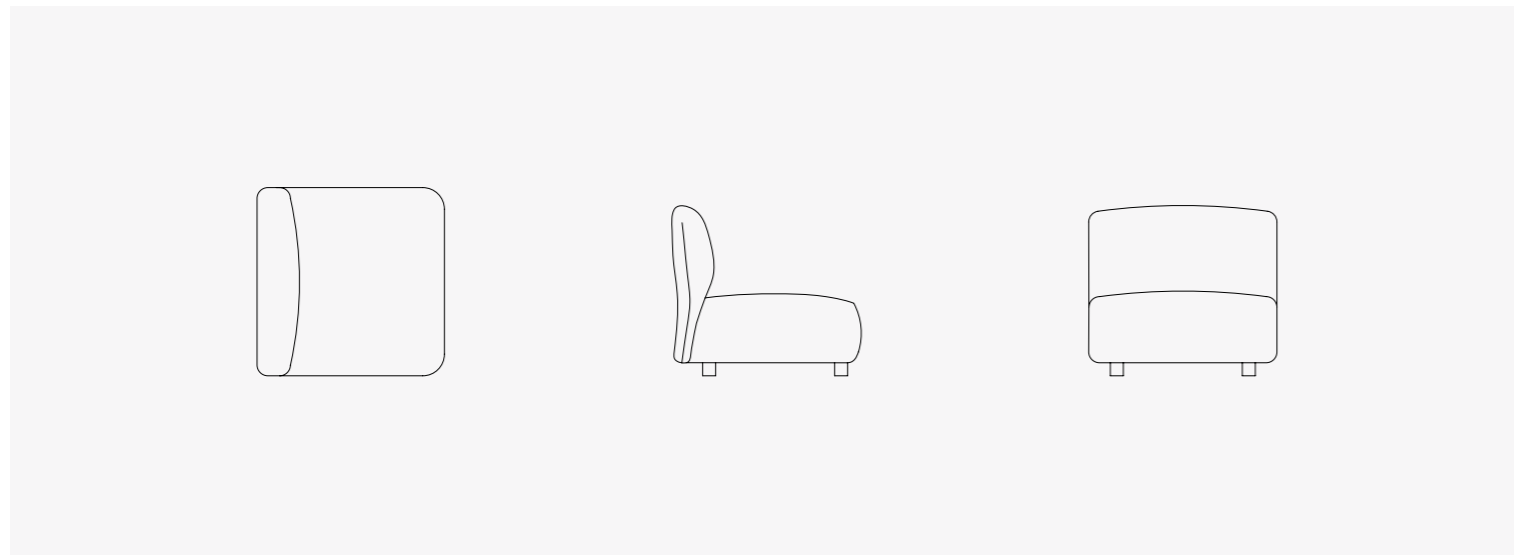

Sofa End Element - 105×95×84 cm

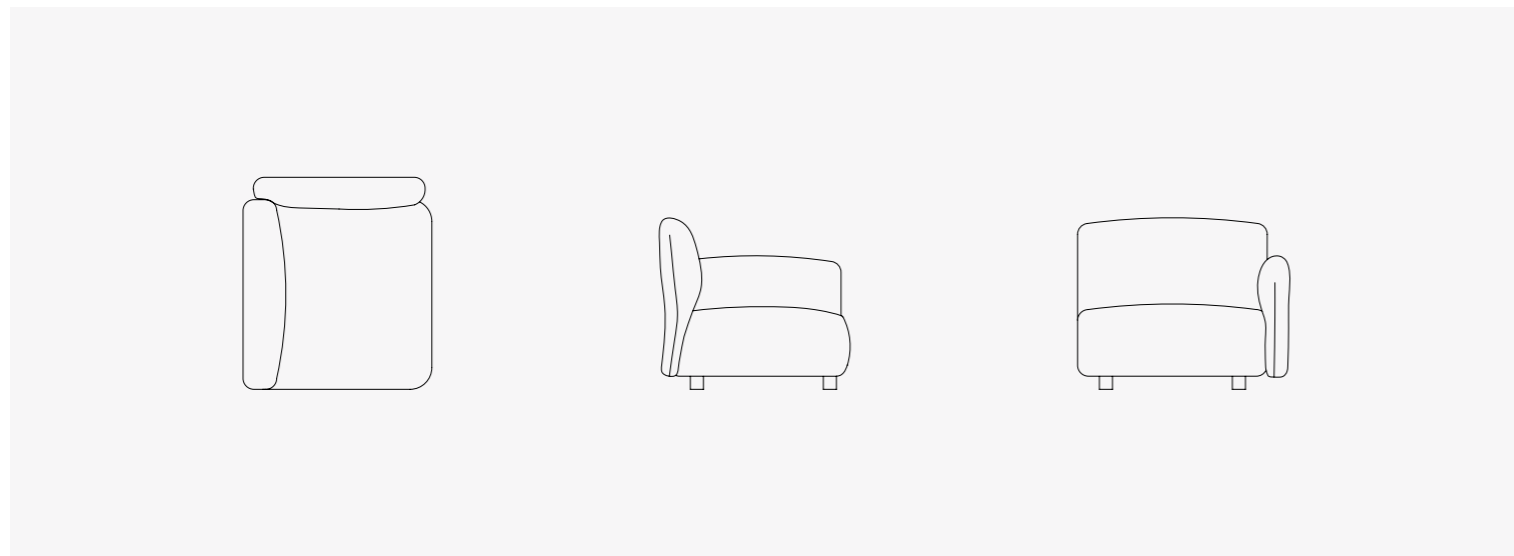

Sofa End Element with Wooden Armrest - 96×95×84 cm



EXTETA X RIVA SOFA

Pouf - 90×80×40 cm

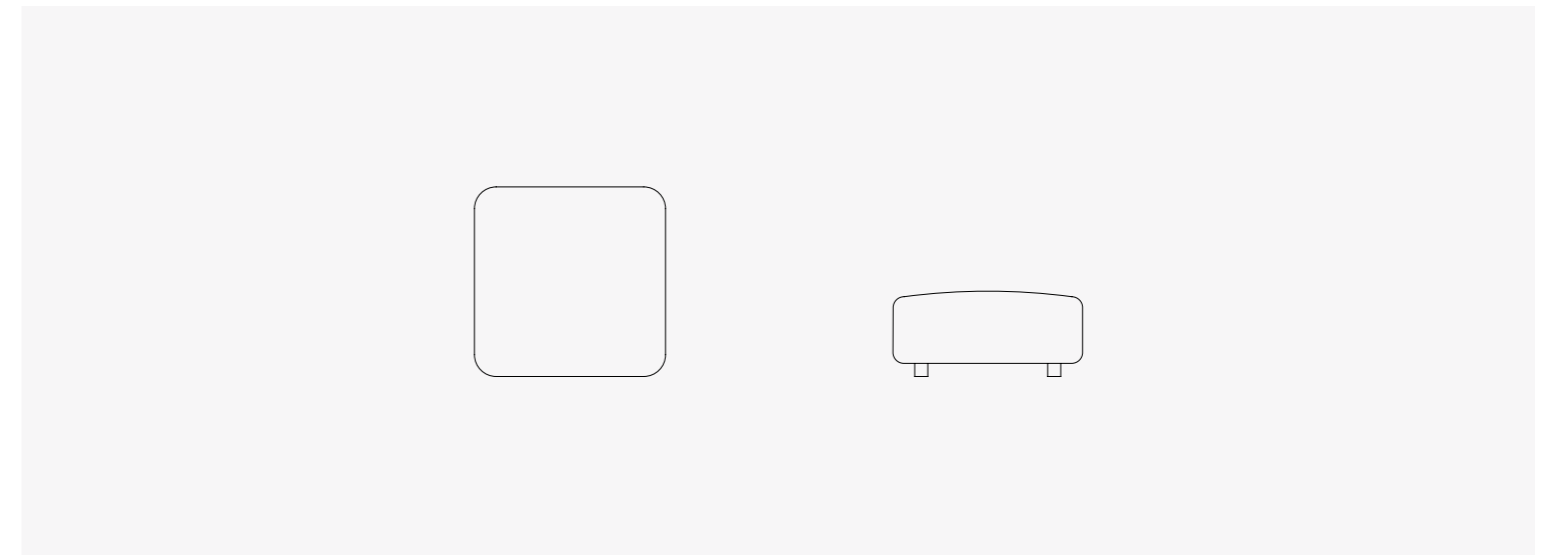

Lounge Chair - 108×95×84 cm

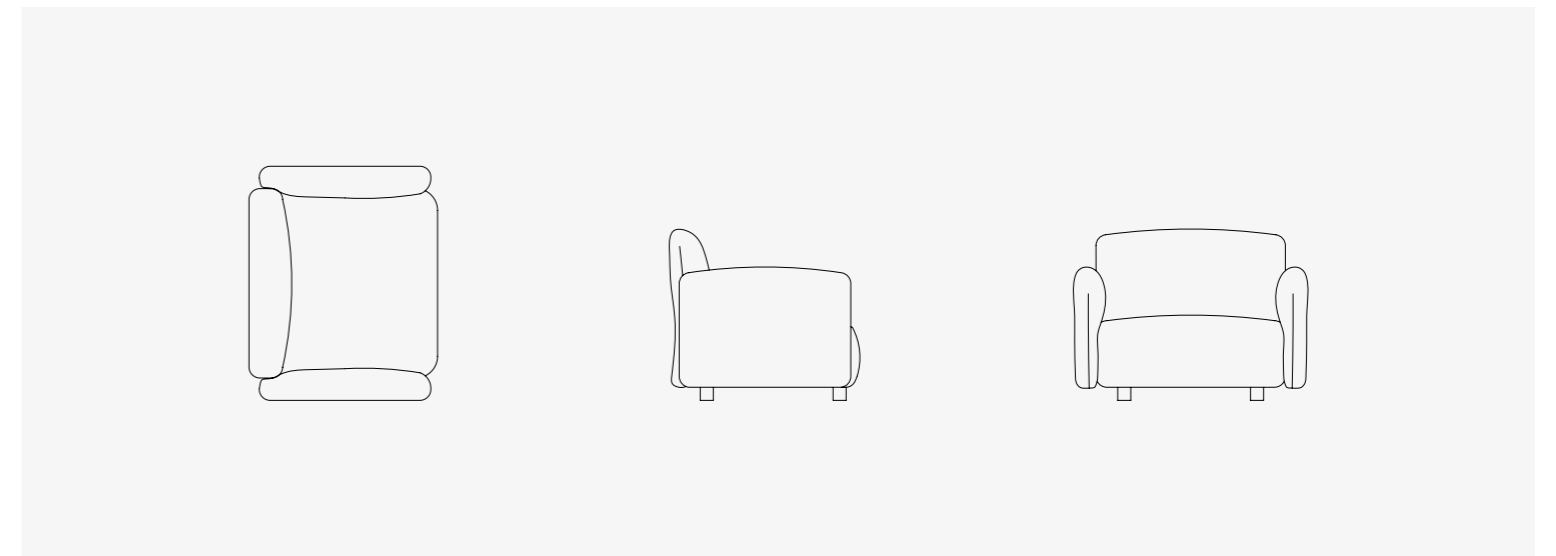

Lounge Chair with Wooden Armrests - 104×95×84 cm



**EXTETA X RIVA
SUN LOUNGER**
Massimo Castagna



STRUCTURE sapelli mahogany
PADDING variable-density high resilience polyurethane comfort foams
INTERNAL LINING waterproof and breathable fabrics
EXTERNAL LINING fabric or leather fabric
FEET stainless steel 316, PVC

DIMENSIONS
212x85x36 cm

PP 10, 98, 107

EN The sun lounger is a nod to Riva's iconic past, reimagined in a style reminiscent of the legendary boats. Its light shape and refined proportions skilfully combine mahogany and stainless steel, complete with soft padding.

IT Il lettino è un omaggio al passato iconico di Riva, riletto attraverso uno stile che richiama le leggendarie imbarcazioni. Leggero nelle forme e raffinato nelle proporzioni, combina sapientemente mogano e acciaio inox, ed è completato da una delicata imbottitura.

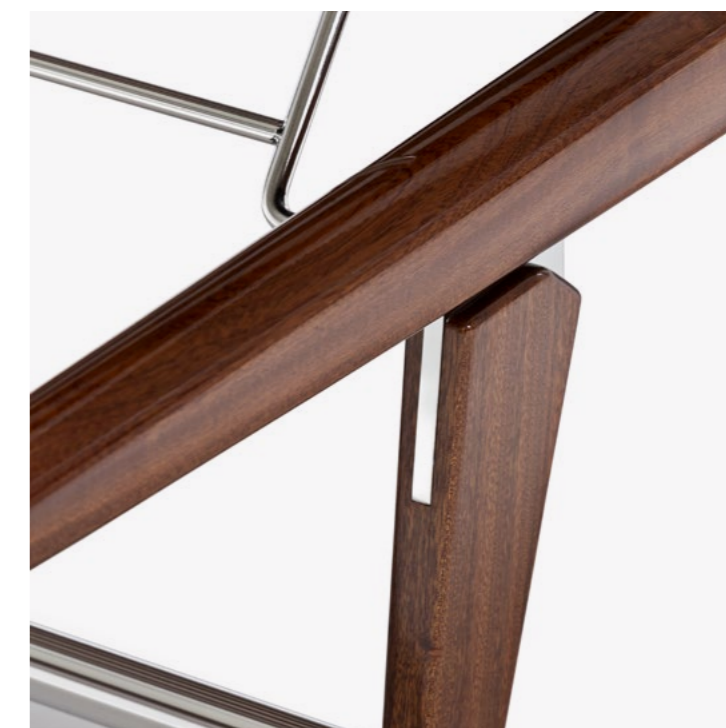

HIKARI LAMP

Massimo Castagna



STRUCTURE coated aluminum, opaline glass
HANDLE saddle leather
LED 2.5 Watt - 190/200 lm/W (Hikari Small), 5 Watt - 190/200 lm/W (Hikari Medium)

DIMENSIONS
 ø10×h20 cm / ø17×h30 cm

PP 40, 44, 46, 132

EN Hikari reinterprets the traditional lantern in a modern, practical, and elegant form. Easy to move, it stylishly lights both indoor and outdoor spaces. Lightweight and versatile, it stands out for its quality materials: opaline glass and painted steel.

IT Hikari reinterpreta la lanterna tradizionale in chiave moderna, pratica ed elegante. Facile da spostare, illumina con stile ambienti interni ed esterni. Leggera e versatile, si distingue per la qualità dei materiali: vetro opalino e acciaio verniciato.

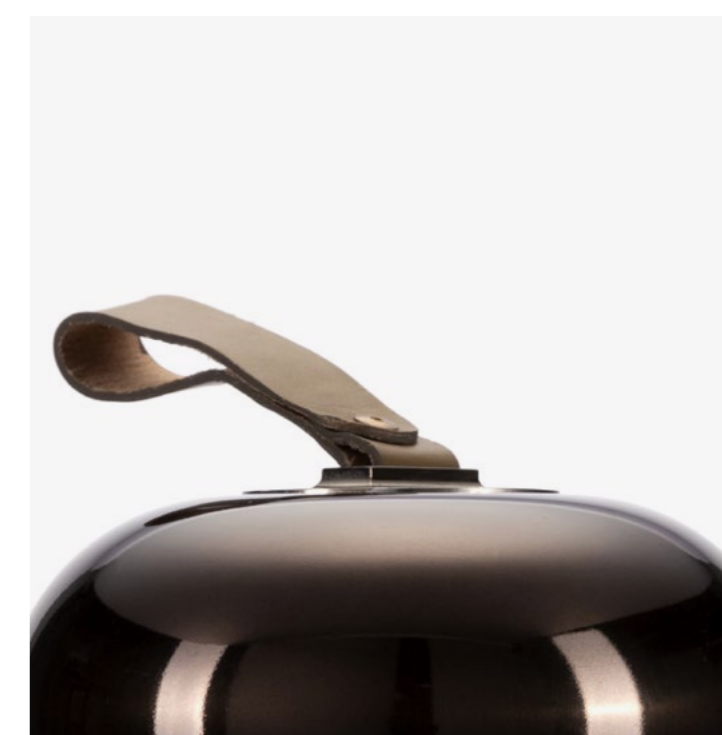

LEVANTE STOOL

Massimo Castagna



STRUCTURE sapelli mahogany
SEATBACK AND SEAT saddle leather
HARDWARE stainless steel

DIMENSIONS
49×53×90 cm / 49×53×105 cm

P 93

EN The Levante stool is a woodworking masterpiece that mimics nature with organic shapes inspired by tree branches. Made from Sapelli mahogany with visible grain, varying thicknesses, and outdoor-treated leather upholstery. A balance of creative skill and natural beauty.

IT Lo sgabello Levante è un capolavoro di ebanisteria che emula la natura con forme organiche ispirate ai rami degli alberi. In mogano Sapelli dalle venature a vista, ha spessori irregolari e seduta in pelle outdoor. Un equilibrio tra ingegno creativo e bellezza naturale.

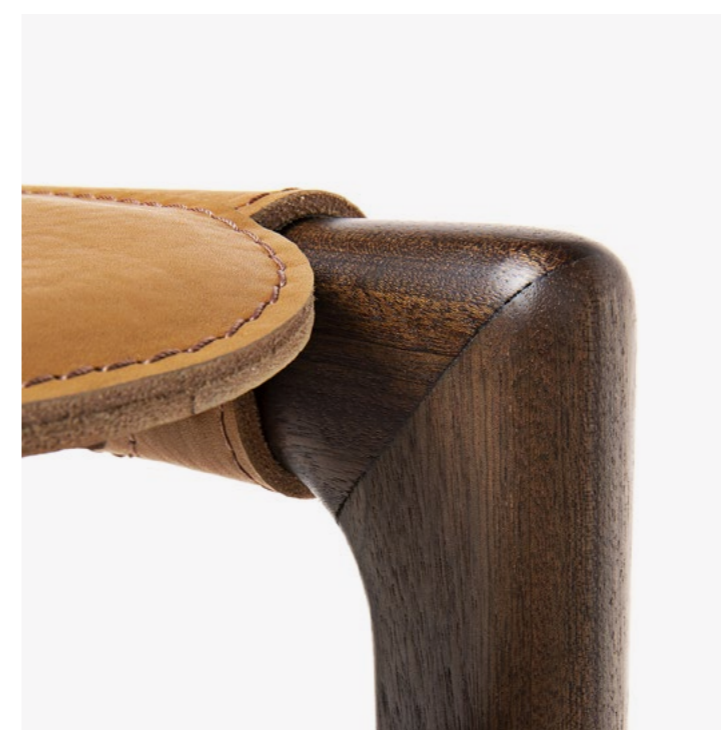
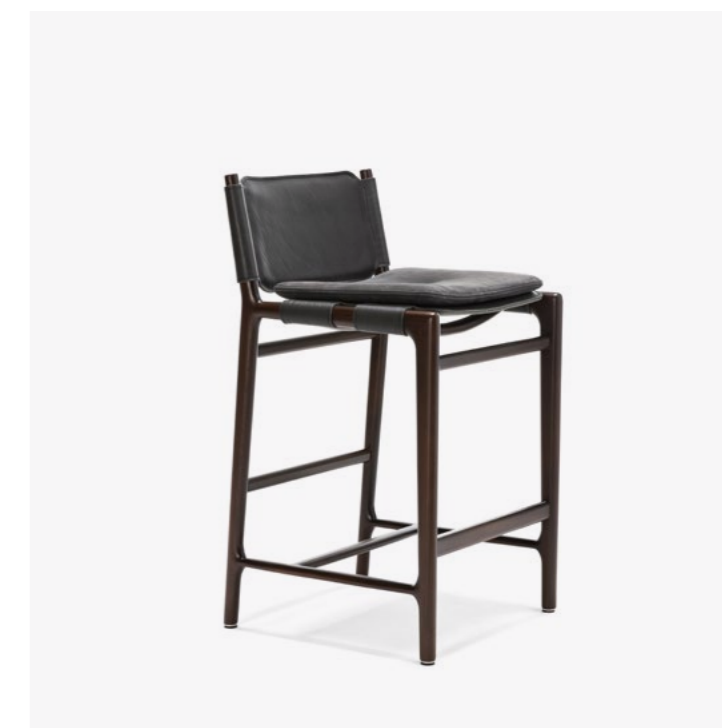

LPIDC01 FOLDABLE DIRECTOR'S CHAIR

Paola Navone OTTO Studio



STRUCTURE sapelli mahogany, polished aluminium
SEATBACK AND SEAT Loro Piana Interiors outdoor fabrics
FEET rubber

DIMENSIONS

63/69×62×85 cm

EN Loro Piana's textile excellence meets Exteta's craftsmanship in the Director Chair: a folding chair in hand-shaped mahogany that reinterprets a design classic with precious materials and Loro Piana fabrics for timeless elegance.

IT L'eccellenza tessile di Loro Piana incontra l'artigianalità di Exteta nella Director Chair: una sedia pieghevole in mogano lavorato a mano, che reinterpreta un classico del design con materiali pregiati e tessuti Loro Piana per un'eleganza senza tempo.



LPIDC02 ARMCHAIR

Paola Navone OTTO Studio



WEAVINGhandwoven cord
 FEETrubber

DIMENSIONS

70/79×73×78 cm

PP 67, 71

EN Retro charm meets modern comfort in this armchair by Loro Piana Interiors and Exteta. Featuring smooth lines in satin-finished Sapelli mahogany, fine fabrics, and padding inspired by the director's chair. Optional wider armrest doubles as a practical side table.

IT Fascino retrò e comfort moderno per la poltrona firmata Loro Piana Interiors ed Exteta. Linee sinuose in mogano Sapelli satinato, tessuti pregiati e imbottiture ispirate alla sedia da regista. Opzionale il bracciolo extra, utile anche come piano d'appoggio.



**LPIDC03
FOLDABLE STOOL**
Paola Navone OTTO Studio



STRUCTURE sapelli mahogany
SEATBACK AND SEAT..... Loro Piana Interiors outdoor fabrics
FEET.....rubber

DIMENSIONS
65x42x38 cm

EN With dual function as a footrest or informal seat, the folding stool proves versatile. Elegant in combining Sapelli mahogany and Loro Piana Interiors fabric, it adds function to any furniture arrangement.

IT Con doppia funzione di poggiatesta e seduta informale, lo sgabello pieghevole si rivela un elemento versatile. Elegante nella combinazione tra mogano Sapelli e tessuto Loro Piana Interiors, aggiunge funzionalità a ogni scenografia d'arredo.

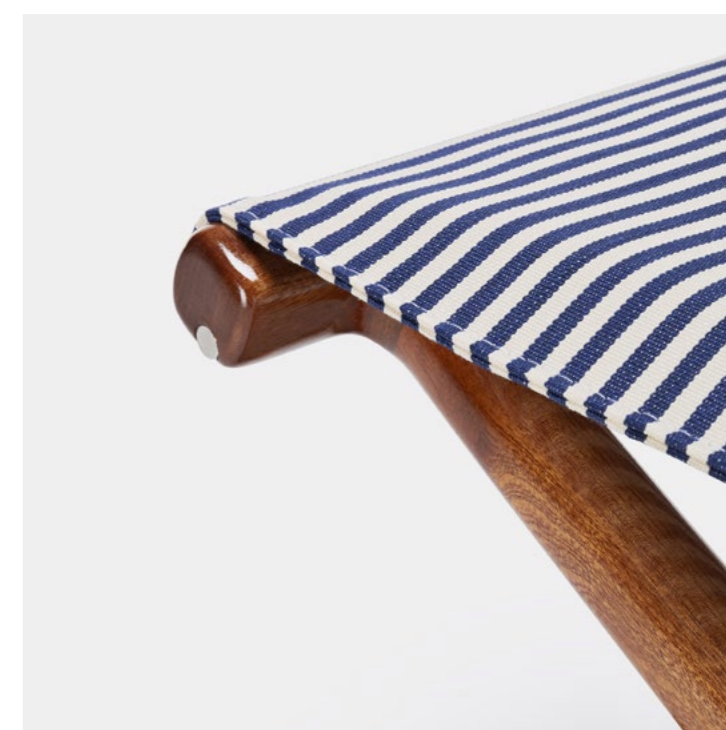
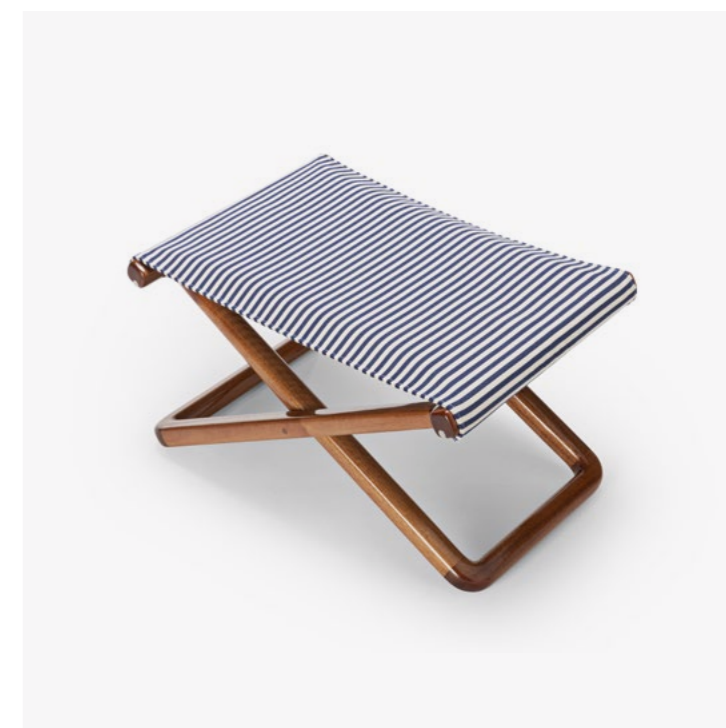

**LPIDC04
SUNBED**

Paola Navone OTTO Studio



STRUCTUREsapelli mahogany
WEAVINGhandwoven cord
HARDWAREstainless steel
SEAT AND SEATBACK..... Loro Piana Interiors outdoor fabric
FEETrubber

DIMENSIONS
212x95x32 cm

PP 66-67

EN With generous dimensions and bold profiles, the lounge stands out elegantly in outdoor spaces. Cozy and comfortable with padded mattress, headrest, and adjustable backrest, it highlights Loro Piana fabrics with artisanal rope weaving.

IT Con dimensioni generose e profili marcati, il lettino si impone con eleganza negli spazi outdoor. Accogliente e confortevole grazie a materassino, poggiatesta e schienale regolabile, valorizza i tessuti Loro Piana con un intreccio artigianale di corde.



**LPIDC05
ROCKING CHAIR**
Paola Navone OTTO Studio



STRUCTUREsapelli mahogany
WEAVINGhandwoven cord
SEAT AND SEATBACK Loro Piana Interiors outdoor fabric
FEET:rubber

DIMENSIONS
70/76×79×83 cm

EN The rocking chair is the most original and playful piece in the collection. Paola Navone reinterprets The Delight Chairs' features, blending wood and Loro Piana fabrics into a poetic piece that evokes familiar gestures and offers moments of comfort and sweetness.

IT La sedia a dondolo è il pezzo più originale e giocoso della collezione. Paola Navone reinterpreta i tratti di The Delight Chairs unendo legno e tessuti Loro Piana in un arredo poetico che evoca gesti familiari e regala momenti di comfort e dolcezza.

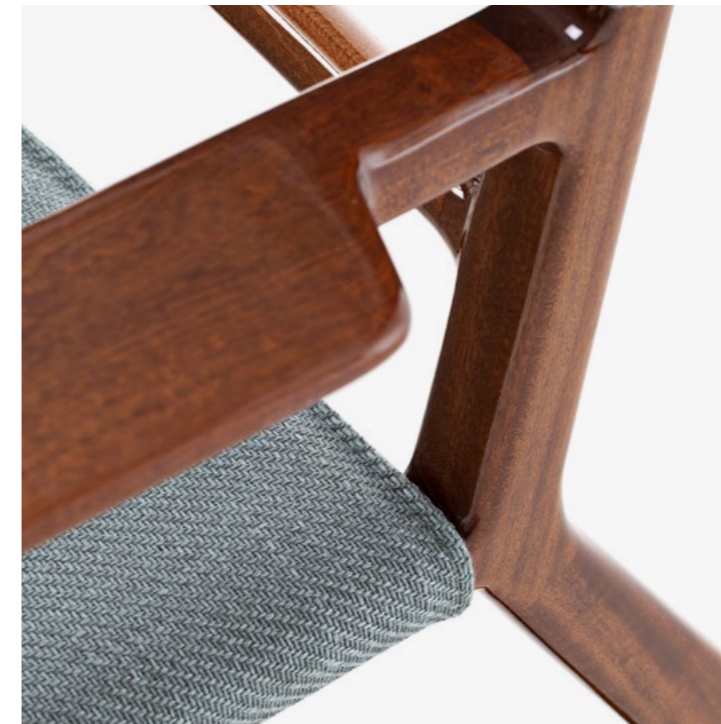

LPIDC06 DINING TABLE

Paola Navone OTTO Studio



STRUCTURE sapelli mahogany
TOP.....marble or stone
FEET.....rubber

DIMENSIONS
110×110×h65/75 cm

EN Compact and versatile, the dining table suits various contexts without sacrificing elegance. Harmonious design pairs noble materials like matte or glossy Sapelli mahogany with marble in various finishes, perfect for outdoor use.

IT Compatto e versatile, il Dining Table si adatta a diversi contesti senza rinunciare all'eleganza. Il design armonioso si unisce a materiali nobili come il mogano Sapelli, opaco o lucido, e il marmo in varie finiture, ideali per l'uso in ambienti outdoor.



LPIDC07 SIDE TABLE

Paola Navone OTTO Studio



STRUCTURE sapelli mahogany
TOP.....marble or stone
FEET.....rubber

DIMENSIONS

32×32×h35 cm / 50×35×h50 cm

PP 71, 80, 82

EN Compact dimensions, maximum elegance. Two service tables echo the main tables' distinctive aesthetics on a smaller scale. Offered in two heights, they can be paired dynamically or used singly beside armchairs, loungers, or sofas.

IT Misure contenute, massima eleganza. I due tavolini di servizio riprendono in scala ridotta l'estetica dei tavoli principali. Disponibili in due altezze, si usano in coppia o singolarmente accanto a poltrone, lettini o divani lounge, creando composizioni dinamiche.

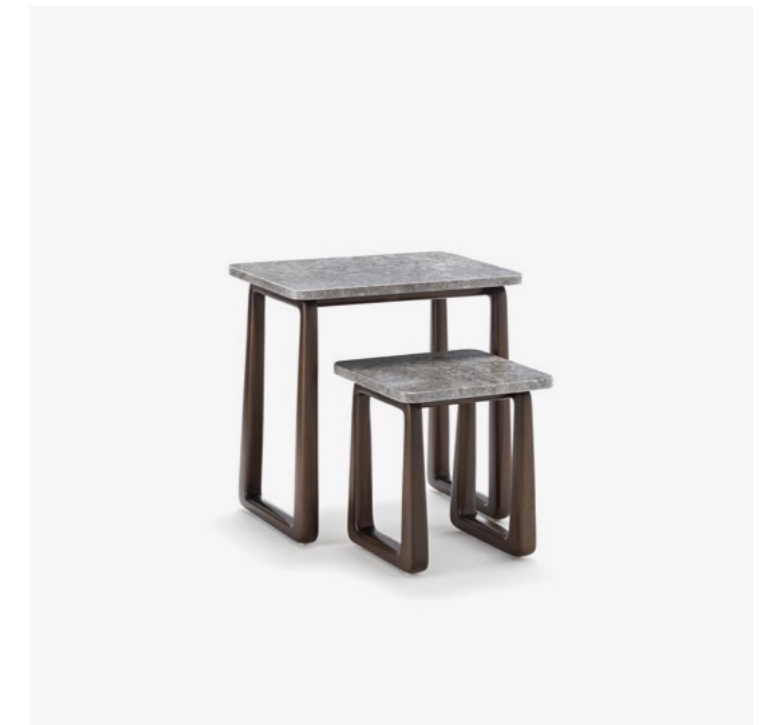

**LPIDC08
LOUNGE CHAIR**

Paola Navone OTTO Studio



STRUCTURE sapelli mahogany
INTERNAL LINING waterproof and breathable fabrics
EXTERNAL LINING Loro Piana Interiors fabrics
PADDING variable-density high resilience polyurethane
FEET rubber

DIMENSIONS
 85/95x89xh68 cm

PP 78, 81-83

EN The lounge chair echoes the LPIDC08 Sofa, sharing compact, solid volumes lightened by a Sapelli mahogany frame. Essential yet tactile, it blends comfort and character to furnish outdoor spaces with understated elegance.

IT La Lounge Chair richiamo il modello LPIDC08 Sofa, con cui condivide volumi compatti e solidi, alleggeriti dalla struttura in mogano Sapelli. Essenziale ma materica, unisce comfort e carattere per arredare gli spazi outdoor con sobria ed elegante coerenza.



**LPIDC08
SOFA**

Paola Navone OTTO Studio



STRUCTUREsapelli mahogany
INTERNAL LINING.....waterproof and breathable fabrics
EXTERNAL LINING.....Loro Piana Interiors fabrics
PADDINGvariable-density high resilience polyurethane
FEET.....rubber

DIMENSIONS
 190/200×89×h68 cm
 / 260/270×89×h68 cm

PP 31, 67

EN The LPIDC08 Sofa balances compactness and enveloping softness. The Sapelli mahogany frame embraces soft cushions covered in Loro Piana Interiors fabrics. Waterproof, plush back cushions lighten the volume for sophisticated outdoor comfort.

IT Il divano LPIDC08 combina compattezza e avvolgenza. La struttura in mogano Sapelli incornicia morbide imbottiture rivestite in tessuti Loro Piana Interiors. I cuscini dello schienale, impermeabili e soffici, alleggeriscono il volume per un comfort sofisticato outdoor.



LPIDC09 WOODEN COFFEE TABLE

Paola Navone OTTO Studio



STRUCTUREsapelli mahogany
FEETrubber

DIMENSIONS
90×65×30 cm / 70×70×30 cm

PP 31, 67, 71

EN A compact version of the wooden dining table, this coffee table blends practicality and style. Entirely mahogany, it's a tribute to fine woodworking: curvilinear hand-finished base and regularly spaced slatted top. Daily elegance.

IT Versione compatta del wooden dining table, questo tavolino unisce praticità e stile. Interamente in mogano, è un omaggio all'ebanisteria: base curvilinea e lavorata a mano, piano a doghe distanziate con finitura regolare e rigorosa. Eleganza quotidiana.

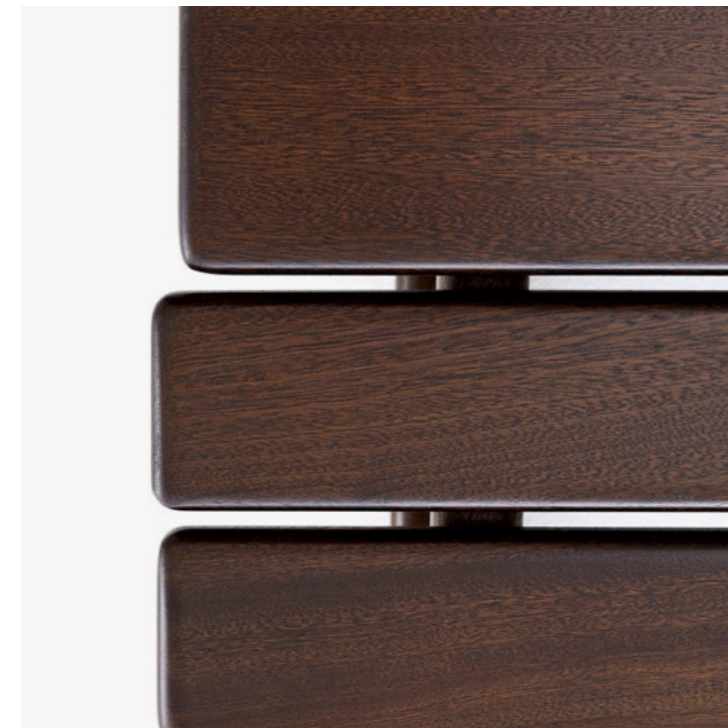

**LPIDC10
COFFEE TABLE**

Paola Navone OTTO Studio



TOP..... marble / Stone
 STRUCTUREsapelli mahogany
 FEET.....rubber

DIMENSIONS
 70x70xh30 cm / 100x100xh25 cm
 / 180x65xh25 cm

PP 78-83

EN An ideal complement to The Delight Chairs, this coffee table pairs with sofas and armchairs in style and coherence. Wood base and stone top create a material link to the dining table. Varied top geometries enhance compositional freedom in outdoor spaces.

IT Ideale complemento di The Delight Chairs, questo tavolino affianca divani e poltrone con stile e coerenza. Base in legno e piano in pietra creano un richiamo materico al Dining Table. Le diverse geometrie esaltano la libertà compositiva degli spazi outdoor.



**LPIDC11
MODULAR SOFA**
Paola Navone OTTO Studio



STRUCTUREPE, stainless steel, polyurethane foam at different densities
INTERNAL LINING.....waterproof and breathable fabrics
EXTERNAL LINING.....Loro Piana Interiors outdoor flame retardant fabrics
FEET..... powder coated aluminium, nylon

DIMENSIONS
See following pages
/vedi le pagine seguenti

PP 78-82

EN LPIDC11 Modular Sofa offers endless configurations for any outdoor setting, from yacht decks to open terraces. Generous padding envelops seats, armrests, and backs, creating a cozy look. Coordinated coffee tables add rhythm and function.

IT LPIDC11 – Modular Sofa offre infinite configurazioni per ogni contesto outdoor, dagli yacht alle terrazze. Ampie imbottiture avvolgono sedute, braccioli e schienali, creando un'estetica accogliente. I coffee table coordinati aggiungono ritmo e funzionalità.



TECHNICAL DATA

Modular Sofa Angular Left - 92×92×75 cm, seat height 39 cm

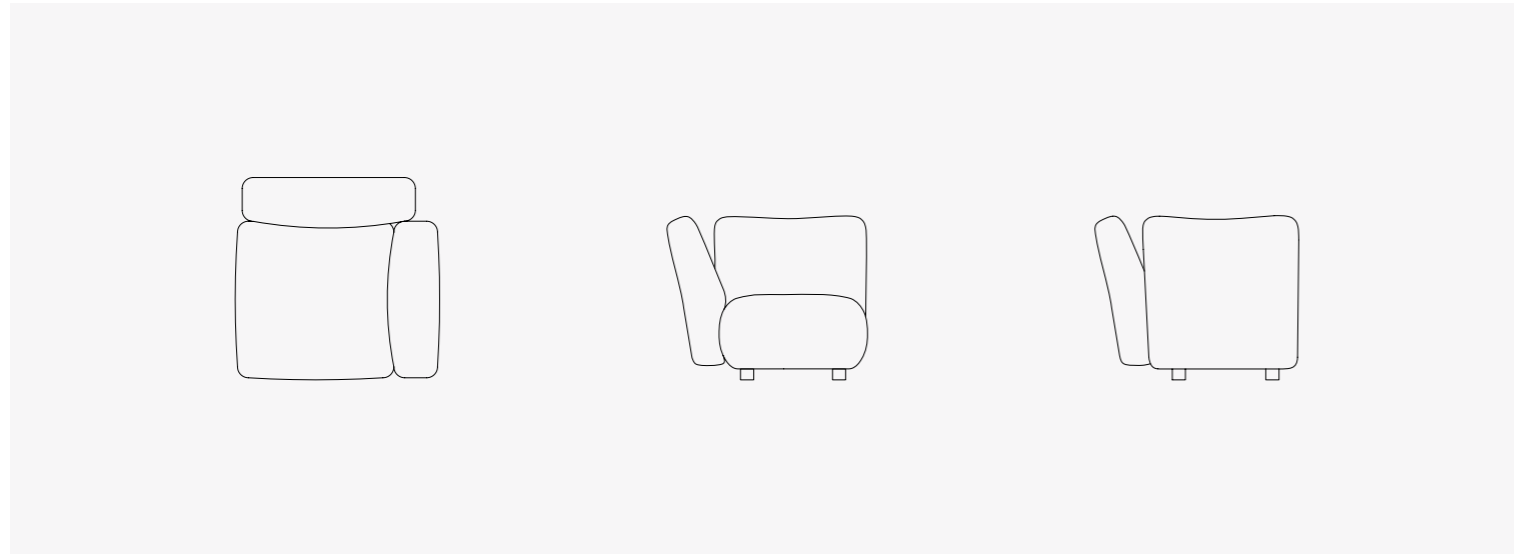

Modular Sofa Angular Right - 92×92×75 cm, seat height 39 cm

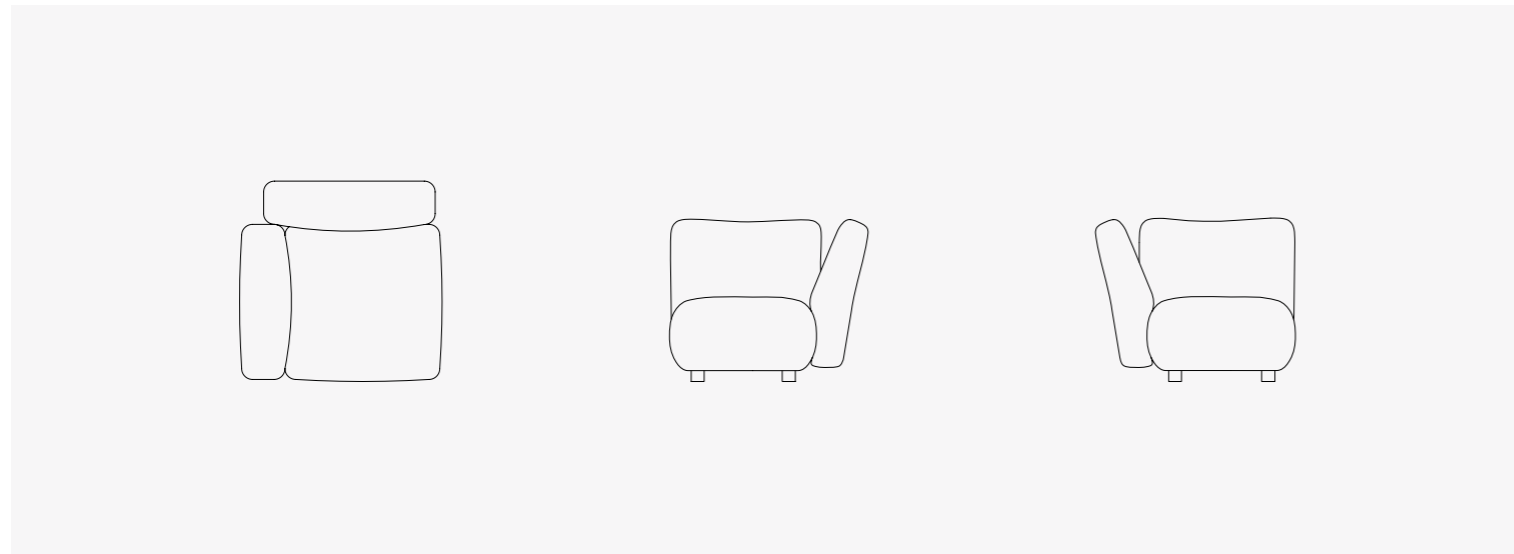

Modular Sofa Central - 90×92×75 cm, seat height 39 cm

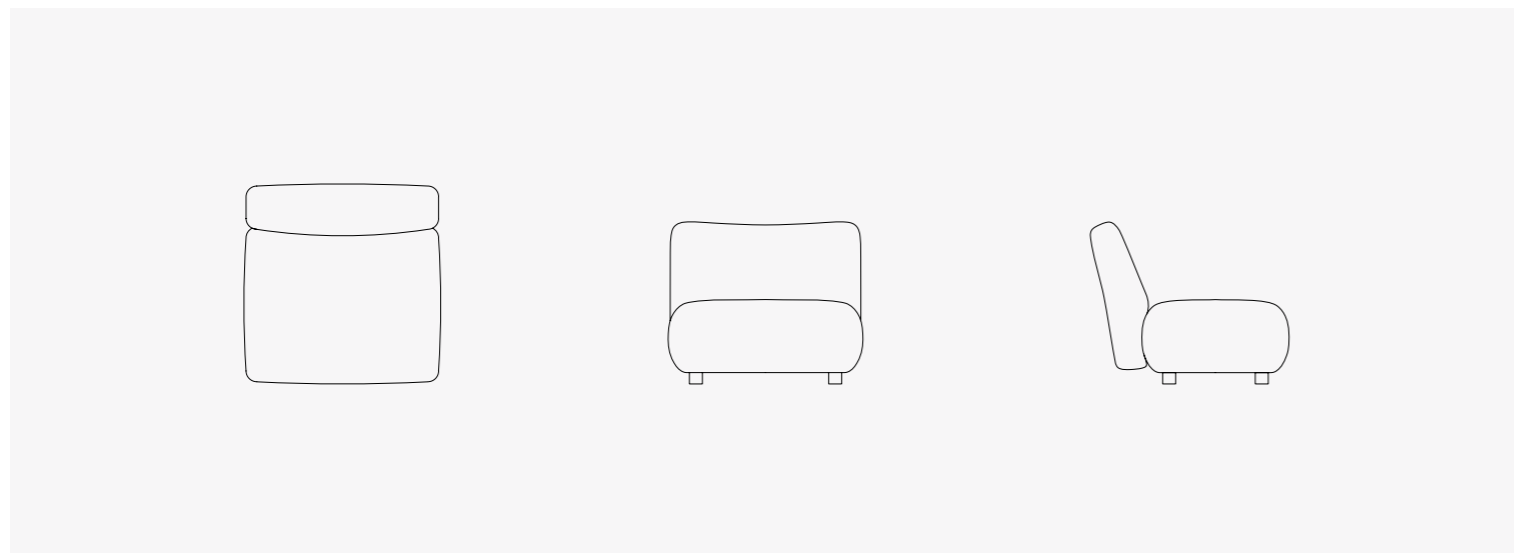

Modular Sofa Chaise Longue Left - 159×106×75 cm, seat height 39 cm

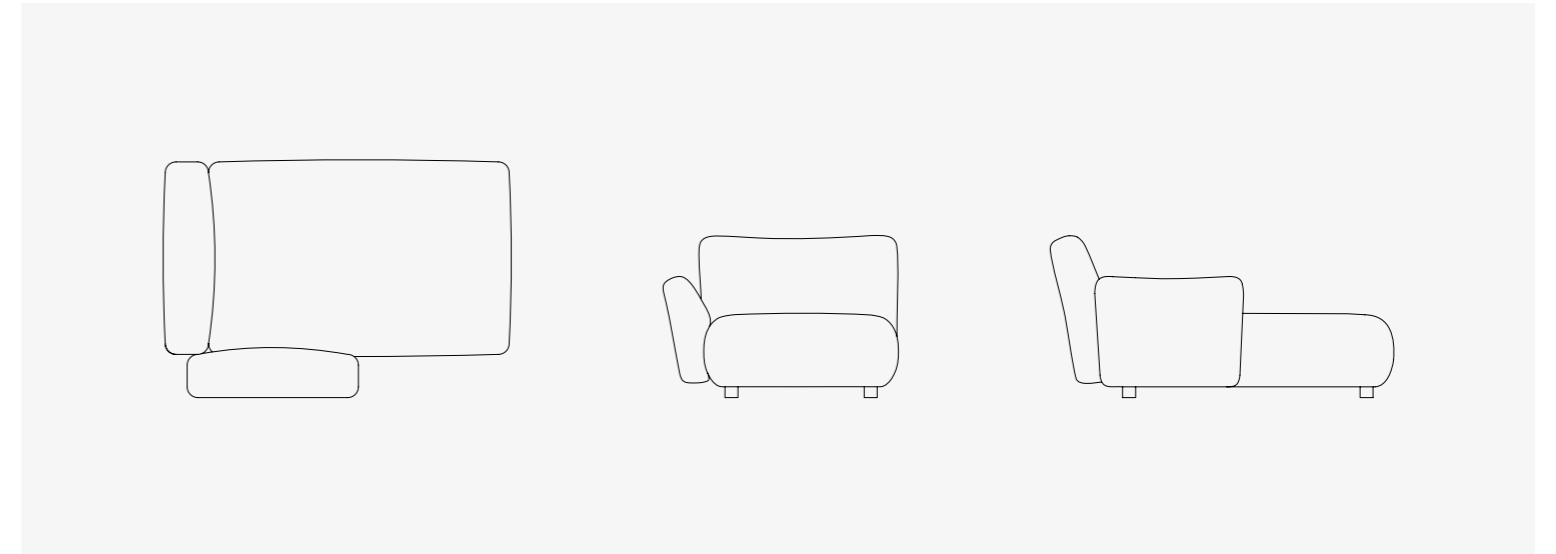

Modular Sofa Chaise Longue Right - 106×159×75 cm, seat height 39 cm

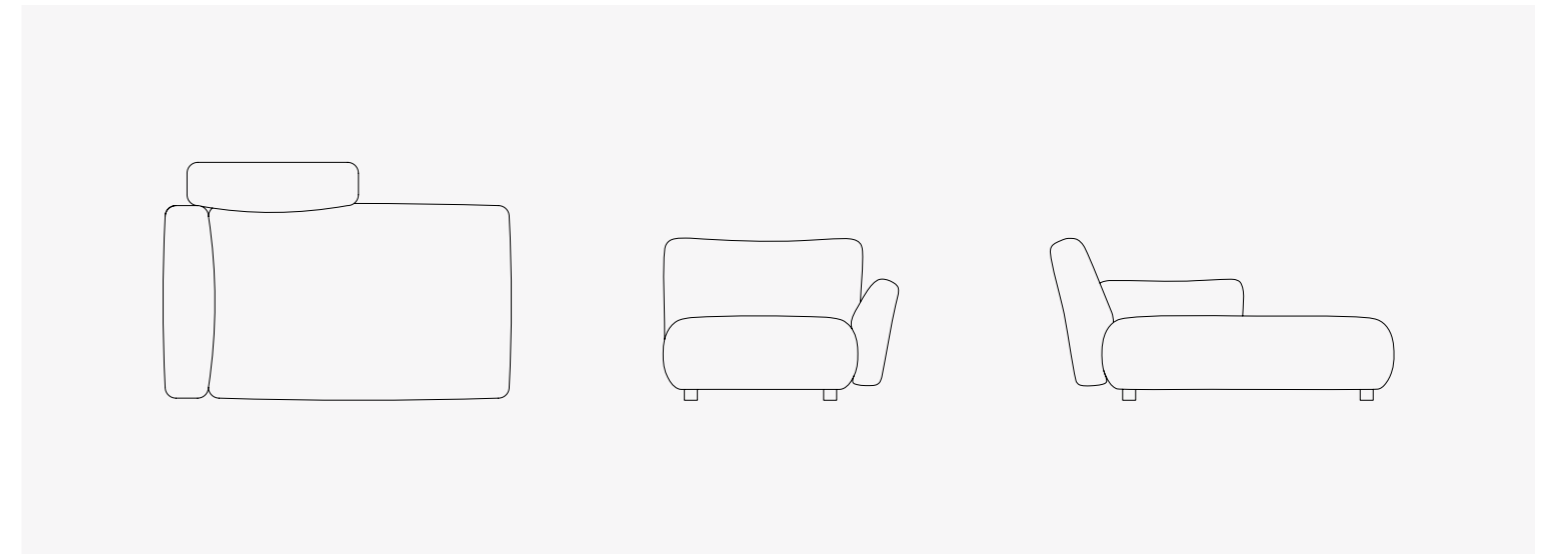

Modular Sofa End Element Left - 110×92×75 cm, seat height 39 cm

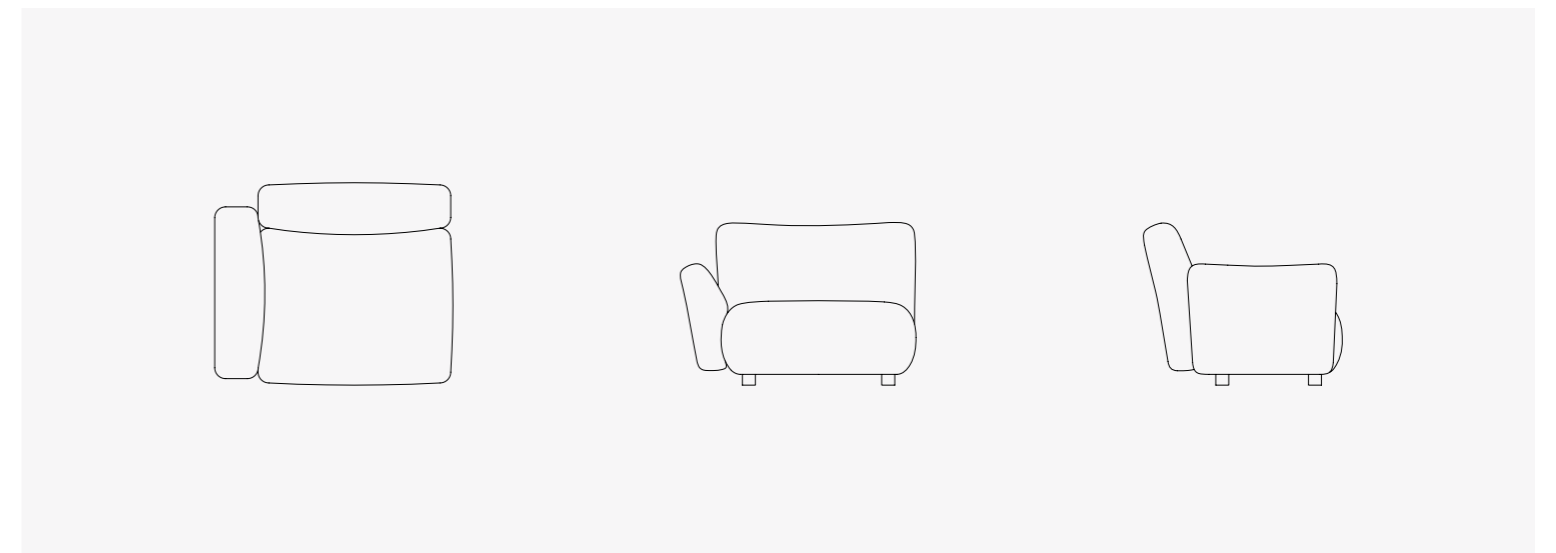

**LPIDC12
DINING CHAIR**

Paola Navone OTTO Studio



STRUCTURE sapelli mahogany
SEATBACK AND SEAT LORO PIANA INTERIORS outdoor flame retardant fabrics, reinforced membrane
FEET rubber

DIMENSIONS

60×62×84 cm

PP 26, 30, 66, 69-70

EN HThe Dining Chair, more compact than the classic director's chair, combines comfort and style. It echoes The Delight Chairs' soft wood curves, extended armrests, and plush padding. Distinctive details include Loro Piana's rubber protectors inspired by iconic footwear.

IT Perfetta con il nuovo tavolo della collezione, la Dining Chair unisce comfort e stile. Più compatta della sedia regista, ha curve morbide, braccioli estesi e imbottiture accoglienti. Distintivo il dettaglio: le protezioni in gomma firmate Loro Piana.



**LPIDC13
BAR STOOL**

Paola Navone OTTO Studio



STRUCTURE sapelli mahogany
SEATBACK AND SEAT..... LORO PIANA INTERIORS outdoor flame retardant fabrics, reinforced membrane
HARDWARE stainless steel 316
FEET.....rubber

DIMENSIONS
57×60×105 cm

P 60

EN In line with The Delight Chairs, the stool faithfully mirrors their aesthetics and materials: a sleek yet sturdy wooden frame, soft contours, plush padding, and comfortable armrests. A functional piece that elegantly blends style with casualness.

IT In linea con The Delight Chairs, lo sgabello ne riprende estetica e materiali: struttura in legno slanciata ma solida, profili morbidi, imbottiture soffici e braccioli comodi. Un elemento funzionale che unisce con eleganza stile e informalità.

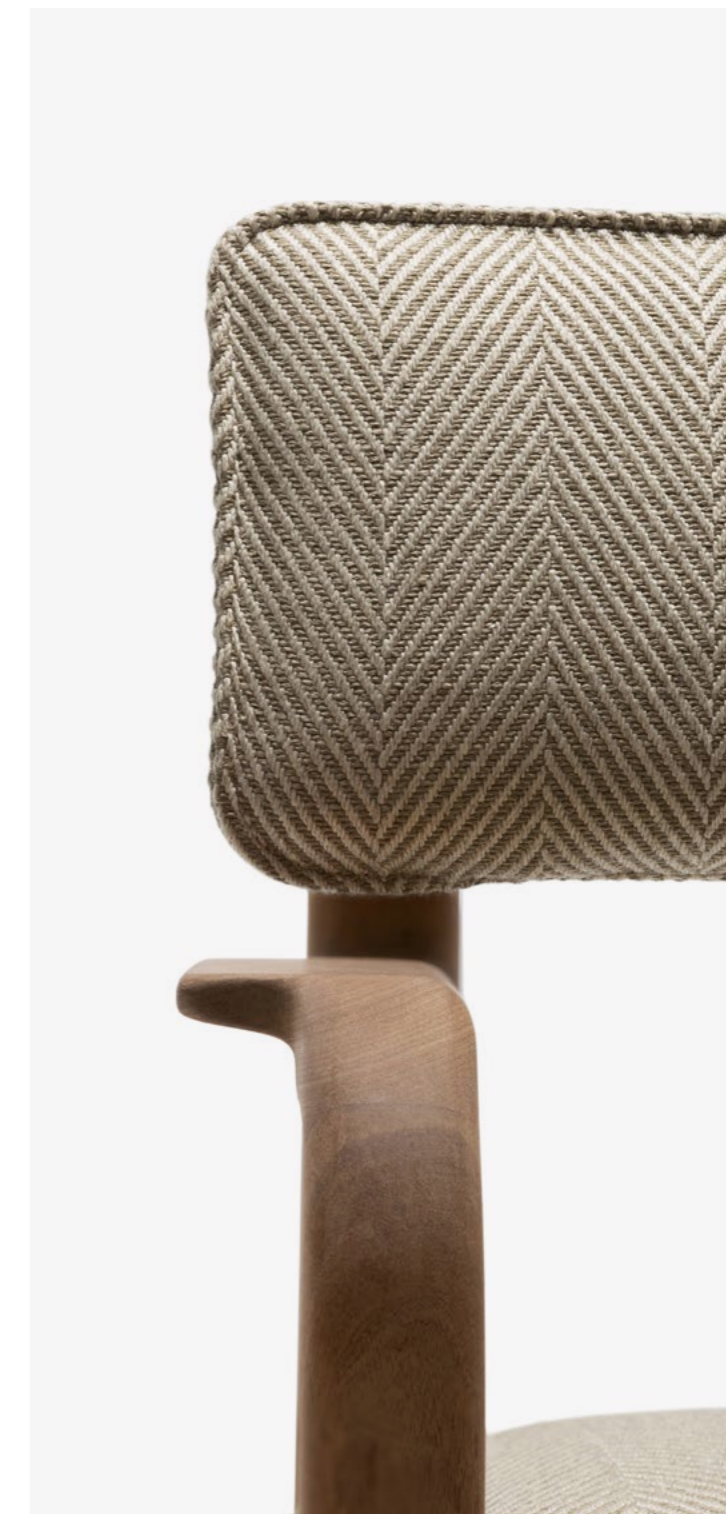

LPIDC14 WOODEN DINING TABLE

Paola Navone OTTO Studio



STRUCTURE sapelli mahogany
CONNECTORS.....brnze
HARDWARE stainless steel 316
FEETrubber

DIMENSIONS
265/320×140×75 cm

PP 26, 66, 69, 70

EN With its finely worked Sapelli mahogany structure, this piece captivates the eye and creates an enveloping atmosphere. The top, lightened by spaced wooden slats, is enriched with matte gold bronze inlays that bring rhythm and movement to the furniture.

IT Con la sua struttura in mogano Sapelli finemente lavorato, questo arredo cattura lo sguardo e crea un'atmosfera avvolgente. Il piano, alleggerito da listelli distanziati, è impreziosito da inserti in bronzo dorato opaco che donano ritmo e movimento.

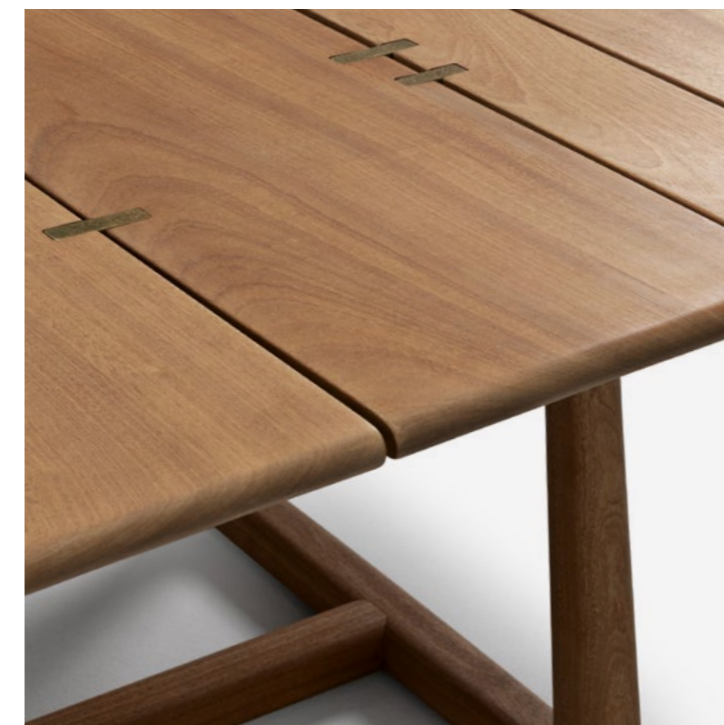
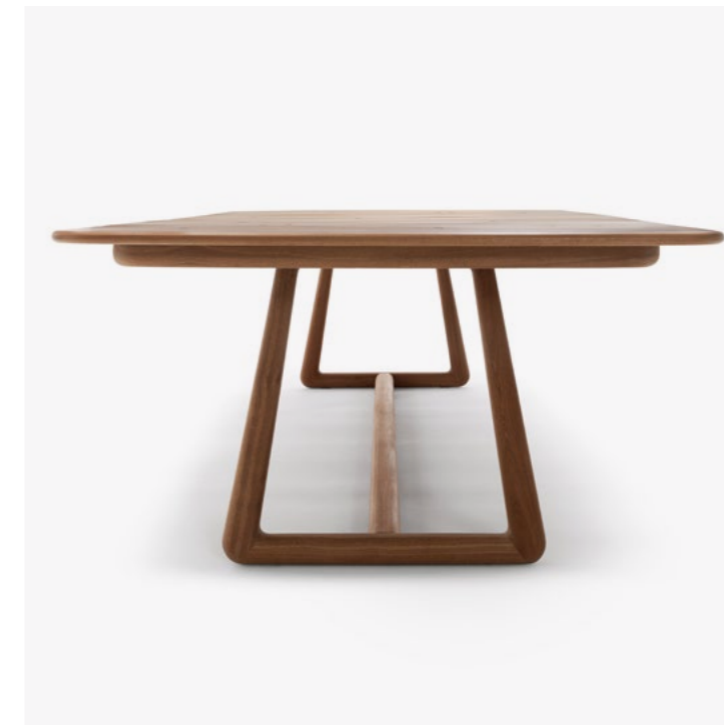

LPIDC15 PORTABLE LAMP

Paola Navone OTTO Studio



STRUCTUREsapelli mahogany

LED 5 Watt, 190/200 lm/W

DIMENSIONS

20×15×39 cm

PP 56, 71, 80

EN In this lamp, light becomes a theatrical presence. The softly curved wooden frame wraps the opaline glass, creating a harmonious dialogue with the space. Portable and versatile, it gracefully accompanies everyday beauty.

IT In questa lampada la luce diventa presenza scenografica. La cornice in legno dalle linee morbide avvolge il vetro opalino, creando un dialogo armonioso con lo spazio. Portatile e versatile, accompagna la quotidianità con eleganza e carattere.



MICHELANGELO DINNER TABLE

Massimo Castagna



STRUCTUREmarble / stone

DIMENSIONS
295/400x150xh75 cm

PP 122-124

EN Inspired by sculpture, Michelangelo is an all-marble table blending art and design. Minimal lines, a thin top, and drop-shaped legs carved from solid marble blocks form a harmonious balance. A classic masterpiece for contemporary interiors.

IT Ispirato al mondo scultoreo, Michelangelo è un tavolo interamente in marmo che unisce arte e design. Linee minimal, piano sottile e gambe a goccia in blocchi massicci creano un equilibrio armonioso. Un capolavoro classico per l'arredo contemporaneo.

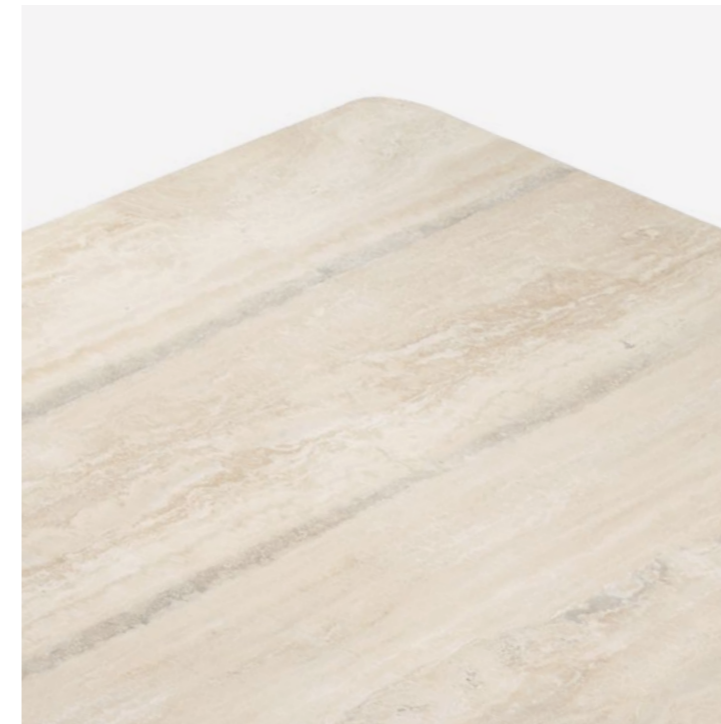

**MOCHI
ARMCHAIR**
Studiopepe



STRUCTUREEPS, polyurethane foam at different densities
INTERNAL LINING.....waterproof and breathable fabrics
EXTERNAL LINING.....fabric or leather
FEET..... PE

DIMENSIONS
85x90x74 cm

P 89

EN Inspired by the famous Japanese sweet, Mochi is a compact, soft armchair by Studiopepe. The embracing seat fits into a rigid leather backrest, creating an elegant contrast. Designed for outdoors, it combines delicacy with durability.

IT Ispirata al celebre dolcetto giapponese, Mochi è una poltrona compatta e morbida, firmata Studiopepe. La seduta avvolgente si inserisce in uno schienale in cuoio rigido, creando un elegante contrasto. Progettata per l'outdoor, unisce delicatezza e resistenza.



MOCHI CHAISE LONGUE

Studiopepe



STRUCTUREEPS, polyurethane foam at different densities
INTERNAL LINING.....waterproof and breathable fabrics
EXTERNAL LINING.....fabric or leather
FEET..... PE

DIMENSIONS
160×85×74 cm

EN Part of Studiopepe's Mochi collection, the chaise longue invites deep relaxation. With an extended seat and extra-soft padding, it pairs full, rounded forms with a rigid, enveloping backrest, balancing rigor and softness.

IT Parte della collezione Mochi di Studiopepe, la Chaise Longue è pensata per il relax profondo. Con seduta allungata e imbottitura extra-soft, unisce forme piene e tondeggianti a uno schienale rigido e avvolgente, in un equilibrio armonioso tra rigore e dolcezza.



MOCHI SOFA
Studiopepe



STRUCTUREEPS, polyurethane foam at different densities
INTERNAL LINING.....waterproof and breathable fabrics
EXTERNAL LINING.....fabric or leather
FEET..... PE

DIMENSIONS
190x105x74 cm

P 89

EN From the recognizable design of the Mochi collection comes the sofa: soft, generous volumes welcome several people in a reassuring embrace, emphasized by a rigid backrest and double cushioning. A playful aesthetic inspired by the famous Japanese sweet.

IT Dal design riconoscibile della collezione Mochi nasce il divano: volumi morbidi e generosi accolgono più persone in un abbraccio rassicurante, enfatizzato dallo schienale rigido e dalla doppia cuscinatura. Un'estetica giocosa ispirata al celebre dolcetto giapponese.



MODERNISTA ARMCHAIR

Studiopepe



STRUCTURE Stainless steel 316, variable-density high resilience polyurethane comfort foams
INTERNAL LINING waterproof and beathable fabrics
EXTERNAL LINING fabric or leather
FEET thermoplastic resin

DIMENSIONS
80x90x70 cm

PP 40, 44-45, 47

EN With '70s flair, Studiopepe's Modernista Armchair blends boldness and softness. The exposed stainless steel frame, inspired by modernist architecture, supports plush, slightly inclined cushions suspended on soft volumes for ergonomic, enveloping comfort.

IT Con richiami anni '70, la poltrona Modernista di Studiopepe unisce audacia e dolcezza. La struttura a vista in acciaio inox, ispirata all'architettura modernista, accoglie cuscini imbottiti e inclinati, sospesi su volumi morbidi per un comfort ergonomico e avvolgente.



MODERNISTA CHAIR

Studiopepe



STRUCTURE Stainless steel 316, variable-density high resilience polyurethane comfort foams
INTERNAL LINING waterproof and beathable fabrics
EXTERNAL LINING fabric or leather
FEET thermoplastic resin

DIMENSIONS

54×63×79 cm

PP 120-122, 124

EN The Modernista Chair adapts the armchair's concept into a sleeker version. Its tubular metal frame sketches an airy, graphic line, while the soft seat and back cushions delicately balance formality and comfort.

IT La Modernista Chair riprende il concept dell'omonima poltrona in una versione più essenziale. La struttura in metallo tubolare disegna una linea aerea e grafica, mentre le imbottiture morbide di seduta e schienale bilanciano rigore formale e comfort.

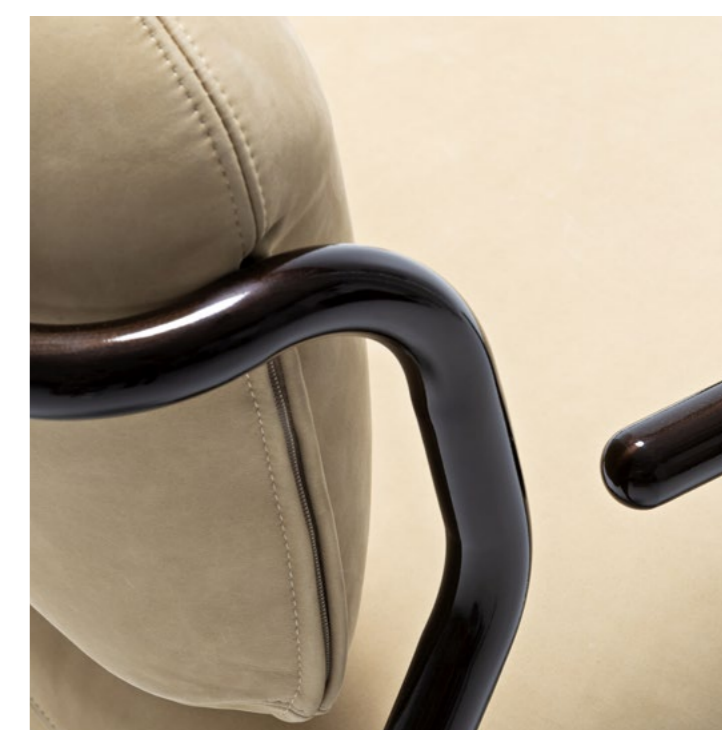

MOONLIGHT DINING TABLE

Paola Navone OTTO Studio



STRUCTURE powder coated stainless steel
TOP marble / stone
LEGS anticorodal aluminium / bronze

DIMENSIONS
300x130xh75 cm

PP 82, 84-87

EN This table fuses industrial and space-age styles with sculptural forms and bold materials. Aluminum or bronze frame, sand-cast for unique detail. A marble top completes the design, highlighting contrast between surfaces and textures.

IT Il tavolo Moonlight unisce stile industrial e space age con forme scultoree e materiali decisi. Struttura in alluminio o bronzo, fuso in sabbia naturale per dettagli unici. Il piano in marmo completa il design, esaltando il contrasto tra superfici e texture.

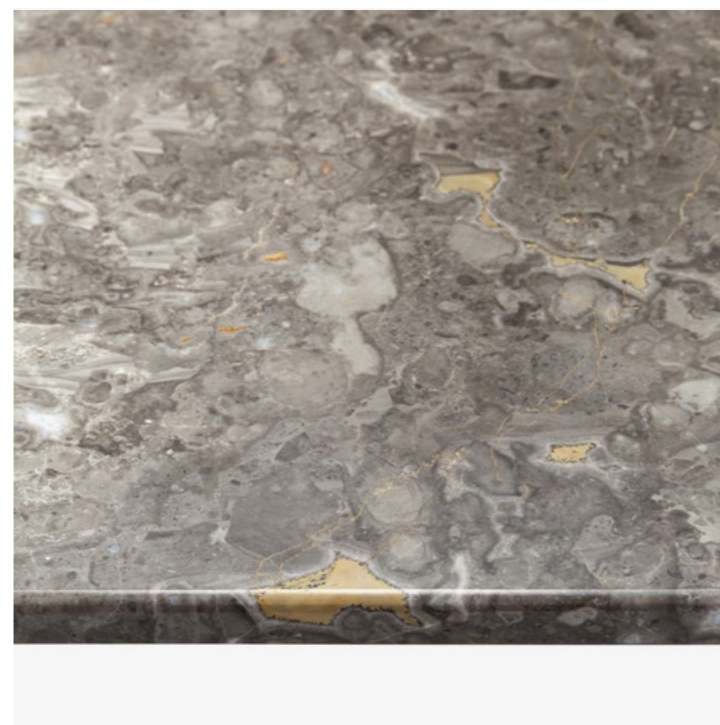

MOONLIGHT SOFT CHAIR

Paola Navone OTTO Studio



STRUCTUREaluminium, polyurethane foam at different densities
INTERNAL LINING..... waterproof and breathable
EXTERNAL LINING.....fabric or leather
FEET..... PE

DIMENSIONS
 60×60×83 cm / 57×60×83 cm

PP 85-87

EN Fully padded and upholstered with fine materials, the Moonlight Soft Chair reinterprets the seating archetype in a soft key. With or without arms, it suits indoor and outdoor, becoming a versatile piece for living, dining, and lounge.

IT Interamente imbottita e rivestita con materiali pregiati, la Moonlight Soft Chair reinterpreta l'archetipo della seduta in chiave morbida. Con o senza braccioli, si adatta a indoor e outdoor, diventando un passe-partout per living, dining e lounge.



**NEREIDE
BASKET**
Studiopepe



STRUCTURE saddle leather
 DETAILS brass

DIMENSIONS
 ø70×h20 cm / ø45×h30 cm

PP 13, 48-49, 54-55, 86,
 88-89, 116-117, 118

EN The Nereide Basket is a study in design and decorative refinement. Made from premium saddle leather with brass details, it showcases Exteta's haute couture craftsmanship. The perforated pattern creates a rhythmic play of light and shadow, ideal for outdoor and nautical settings.

IT Sintesi progettuale e raffinatezza decorativa: il cestino Nereide, in pelle selleria e dettagli in ottone, esalta l'artigianato haute couture di Exteta. Il pattern traforato crea giochi di luce e volumi, ideale per l'outdoor e perfetto in ambienti nautici.

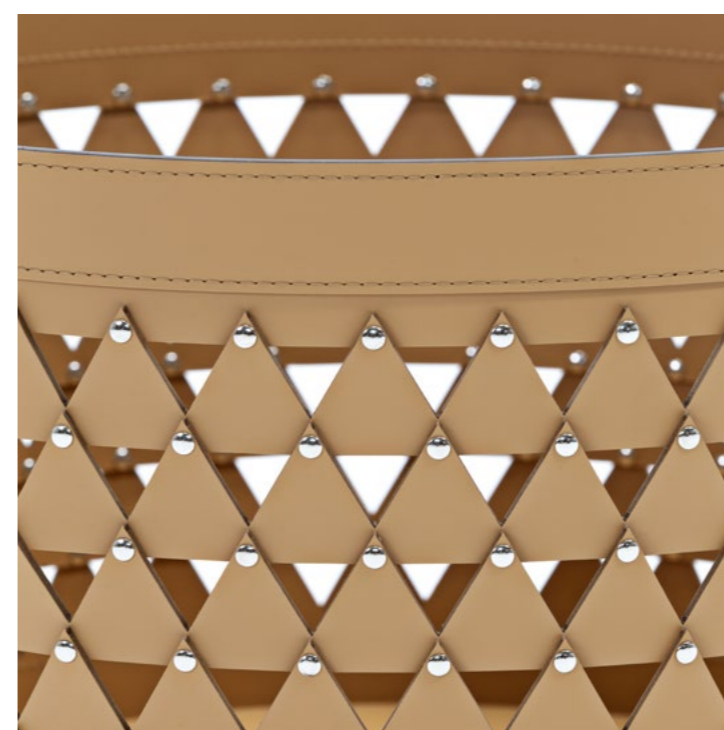

NO-GLUE ARMCHAIR

Massimo Castagna



STRUCTURE sapelli mahogany
PADDING polyurethane foam at different densities
INTERNAL LINING waterproof and breathable fabric
EXTERNAL LINING fabric or leather
HARDWARE stainless steel 316

DIMENSIONS
88x90x81 cm

PP 128, 131

EN No-Glue is a sustainable, innovative armchair made without glue, relying on clever interlocking and mechanical fastenings. Easy to disassemble and repair, it combines technical ingenuity, vintage appeal, and durability with reduced environmental impact.

IT NoGlue è una poltrona sostenibile e innovativa, realizzata senza colle ma con incastri e chiusure meccaniche. Facile da smontare e riparare, unisce ingegno tecnico, estetica vintage e durabilità, riducendo l'impatto ambientale con un design etico.



PANAREA COFFEE TABLE

Massimo Castagna



STRUCTURE marble/ stone
TOP..... sapelli mahogany

DIMENSIONS

220×57×30 cm

PP 43, 48-49, 54-55

EN Between a coffee table and a pouf, this coffee table by Massimo Castagna blends aesthetics and function. With a marble base and geometric patterned mahogany top, it stands out with interchangeable trays or cushions that attach to the slatted elements.

IT Tra tavolino e pouf, Panarea di Massimo Castagna unisce estetica e funzionalità. Con base in marmo e piano in mogano a motivi geometrici, si distingue per accessori intercambiabili – vassoi o cuscini – che si agganciano agli elementi listellari.

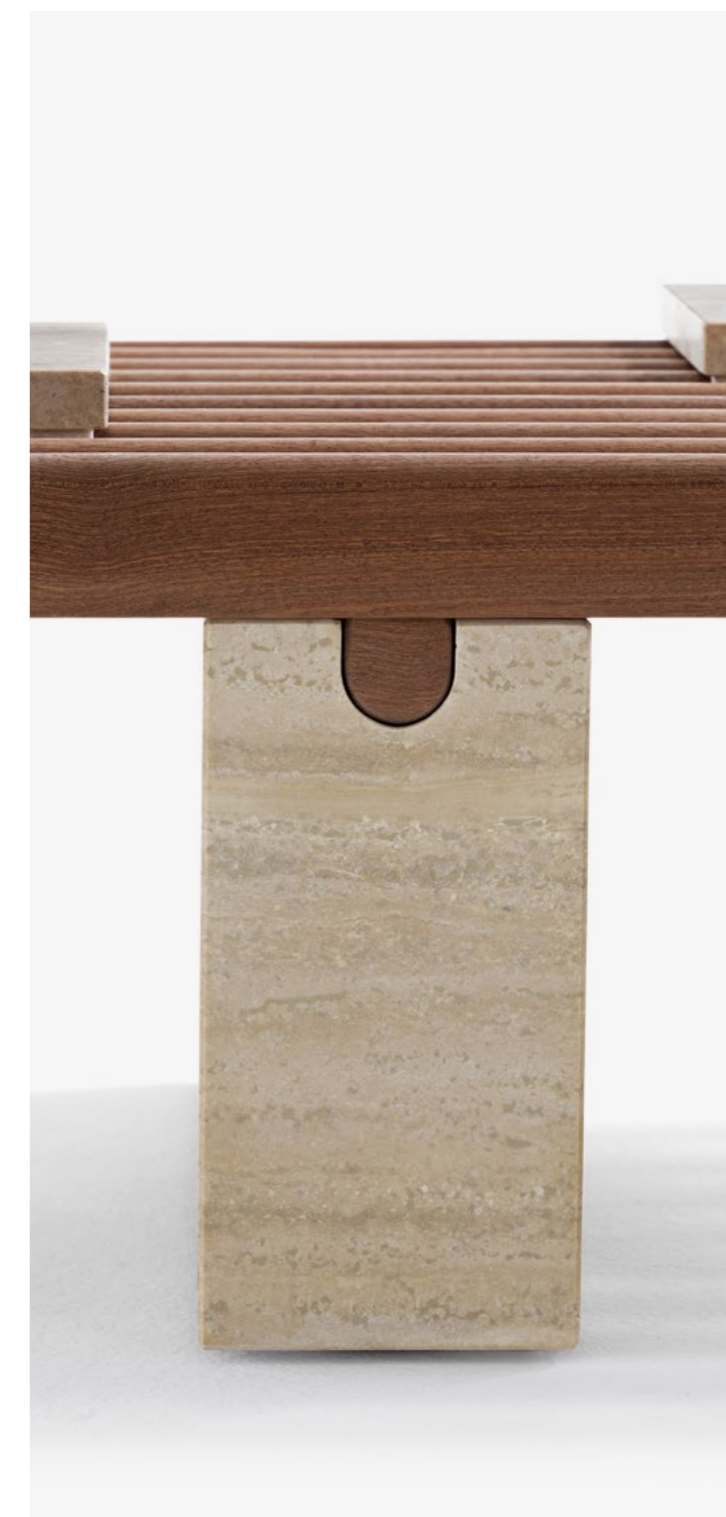

**PERISCOPIO
ARMCHAIR**

Studiopepe



STRUCTURE PE, EPS, polyurethane foam at different densities
INTERNAL LINING waterproof and breathable fabrics
EXTERNAL LINING fabric or leather
FEET stainless steel

DIMENSIONS
85×100×72 cm

PP 40, 44

EN Iconic and eclectic, the Periscopio Armchair reinterprets '70s style codes with boldness and freedom. Its central body, made of five padded tubes lined up, plays with modularity and expresses curvilinear design experimentation.

IT Iconica ed eclettica, la poltrona Periscopio reinterpreta i codici stilistici anni '70 con audacia e libertà creativa. Cinque tubi imbottiti affiancati compongono la sua forma centrale, in un gioco modulare che esprime sperimentazione e design curvilineo.



**PERISCOPIO
CHAISE LONGUE**

Studiopepe



STRUCTURE PE, EPS, polyurethane foam at different densities
INTERNAL LINING waterproof and breathable fabrics
EXTERNAL LINING fabric or leather
FEET stainless steel

DIMENSIONS

200x85x72 cm

EN The Periscopio Chaise Longue highlights the collection's tubular rhythmic forms. Its horizontal seat welcomes relaxation and renewal. Studiopepe's concept draws from the '70s, an era of bold creativity and freedom.

IT La Chaise Longue Periscopio esalta le forme tubolari e ritmiche della collezione. Con la sua seduta orizzontale, accoglie il relax con energia nuova. Studiopepe la concepisce ispirandosi agli anni '70, epoca di libertà creativa e sperimentazione audace.



PERISCOPIO COFFEE TABLE

Studiopepe



STRUCTUREmarble / stone

DIMENSIONS
50/70×70×25 cm / 70×55×25 cm
/ 140×70×2 cm

PP 40, 44-46

EN Born as an independent design, the Periscopio Coffee Table perfectly complements the collection's soft volumes. Its essential geometric shapes and noble materials like marble, stone, and travertine define a modular design. The Arc version's curved edges echo the seats.

IT Nato come progetto autonomo, il tavolino Periscopio si abbina perfettamente ai volumi morbidi della collezione. Forme geometriche essenziali e materiali nobili come marmo, pietra e travertino definiscono un design modulare. Nella versione Arc, i profili curvi richiamano le sedute.



**PERISCOPIO
SOFA**
Studiopepe



STRUCTUREEPS, polyurethane foam at different densities
INTERNAL LINING.....waterproof and breathable fabrics
EXTERNAL LINING.....fabric or leather
STRUCTUREmarble / stone

DIMENSIONS
170x100x72 cm

PP 40, 45, 46

EN Periscopio Sofa is an expressive couch that channels '70s design with a series of padded tubes aligned side by side. Suitable for both indoor and outdoor, it combines seriality and dynamic style, especially in multiples or paired with the collection's coffee tables.

IT Periscopio Sofa è un divano espressivo che richiama il design anni '70 con una sequenza di tubi imbottiti affiancati. Ideale per outdoor e indoor, unisce serialità e dinamismo, soprattutto in composizioni multiple o abbinato ai coffee table della linea.



EXTETA

TECHNICAL DATA

Armchair - 85×100×72 cm, seat height 38 cm

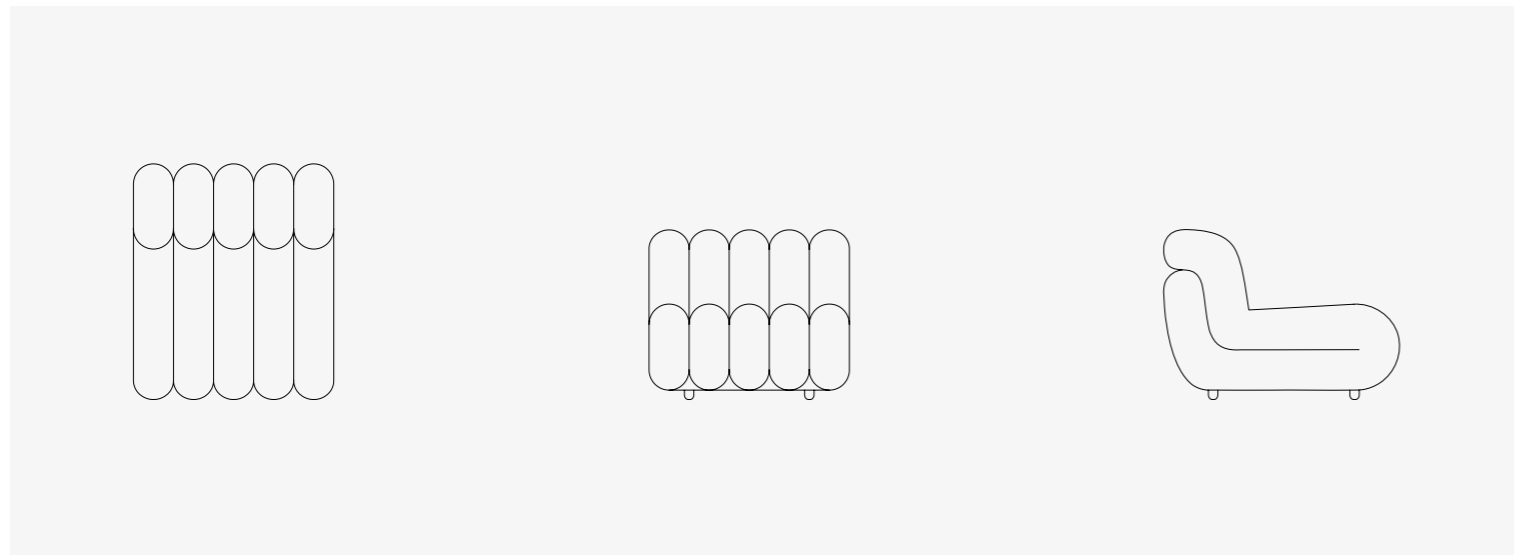

Sofa - 170×100×72 cm, seat height 38 cm

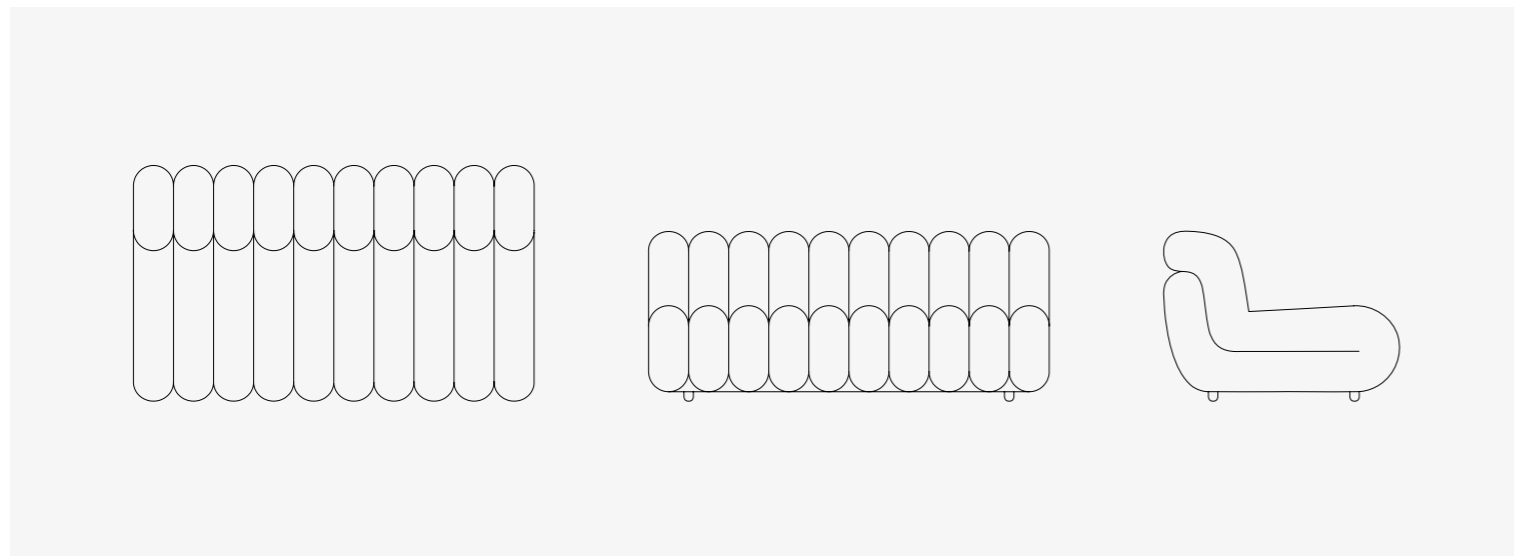

Chaise Longue - 200×85×72 cm, seat height 38 cm

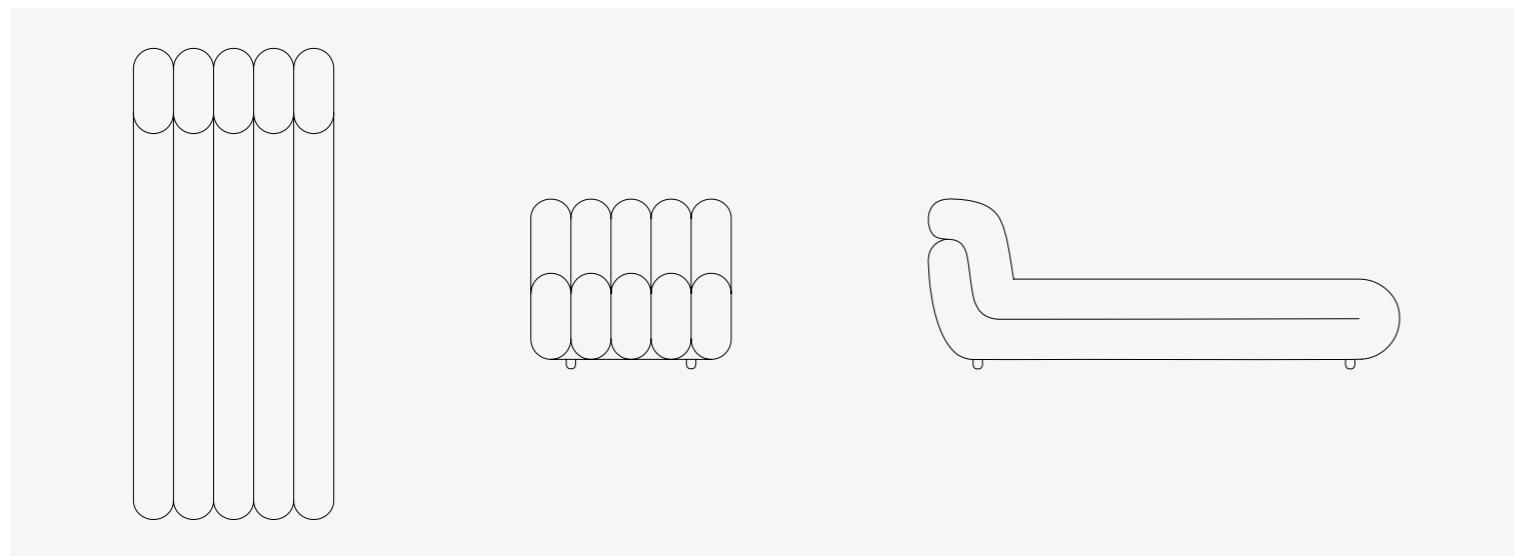

PERISCOPIO SOFA

Periscopio Sofa composition - 450×625 cm

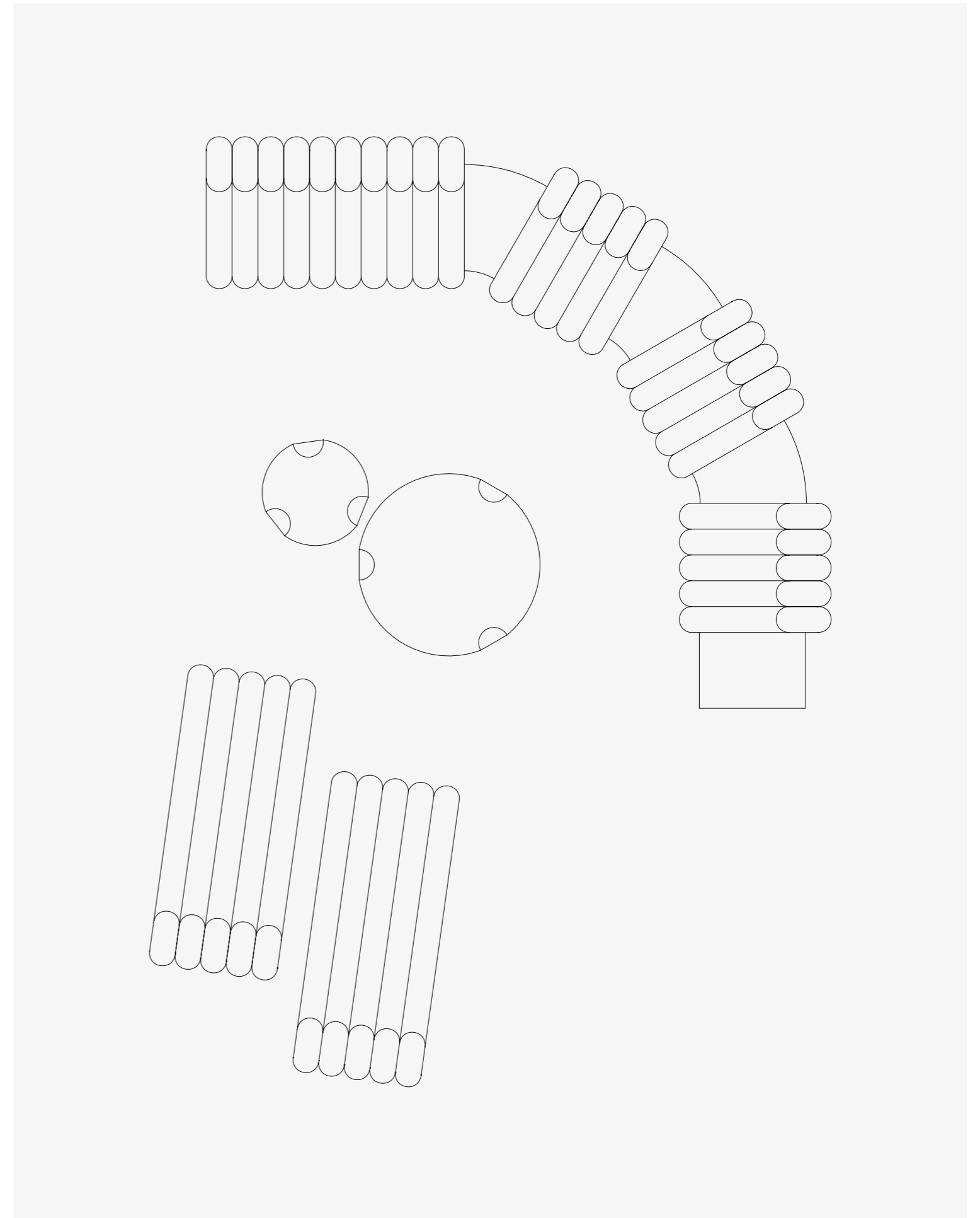

SERELE COFFEE TABLE

Studiopepe



STRUCTUREmarble / stone

DIMENSIONS

ø120×h33 cm / ø70×h45 cm
/ ø40×h55 cm

PP 40, 44-45, 46, 85-86, 89

EN Serele tables recall a Morandi painting's balance, with geometric lines, softened corners, and neutral tones. Half-cylinder legs fit into the top. Available in marble or stone, in three sizes, they suit outdoor environments perfectly.

IT Linee geometriche, angoli smussati e toni neutri definiscono i tavolini Serele, ispirati all'equilibrio di un dipinto di Morandi. Le gambe, cilindri dimezzati, si incastrano nel top. In marmo o pietra e tre dimensioni, sono ideali per l'outdoor.



SHELL ARMCHAIR

Studiopepe



STRUCTURE stainless steel, saddle leather, internal padding

DIMENSIONS

84x72x77 cm

PP 42, 52-53, 132-133

EN The Shell armchair by Studiopepe embraces the body with fluid lines inspired by a seashell. Clad in saddle leather with a stainless steel frame, it blends comfort and rigor in timeless elegance that celebrates craftsmanship.

IT La poltrona Shell di Studiopepe avvolge il corpo con linee fluide ispirate alla forma di una conchiglia. Rivestita in pelle selleria e con struttura in acciaio inox, unisce comfort e rigore formale in un'eleganza senza tempo che celebra la maestria artigianale.



SHELL CHAIR

Studiopepe



STRUCTURE stainless steel, saddle leather, internal padding

DIMENSIONS

66×58×83 cm

PP 58-59, 64

EN "More than a seat, it's a gesture": this is how Studiopepe describes the Shell Chair, inspired by a seashell. Enveloping and sculptural, it echoes the armchair with saddle leather, stainless steel, and artisanal care.

IT "Più che una seduta, è un gesto": così Studiopepe descrive la Shell Chair, ispirata alla forma di una conchiglia. Avvolgente e scultorea, riprende materiali e linee della poltrona omonima: rivestita in pelle selleria, con struttura in acciaio inox e cura artigianale.



STECCA LIGHT

Massimo Castagna

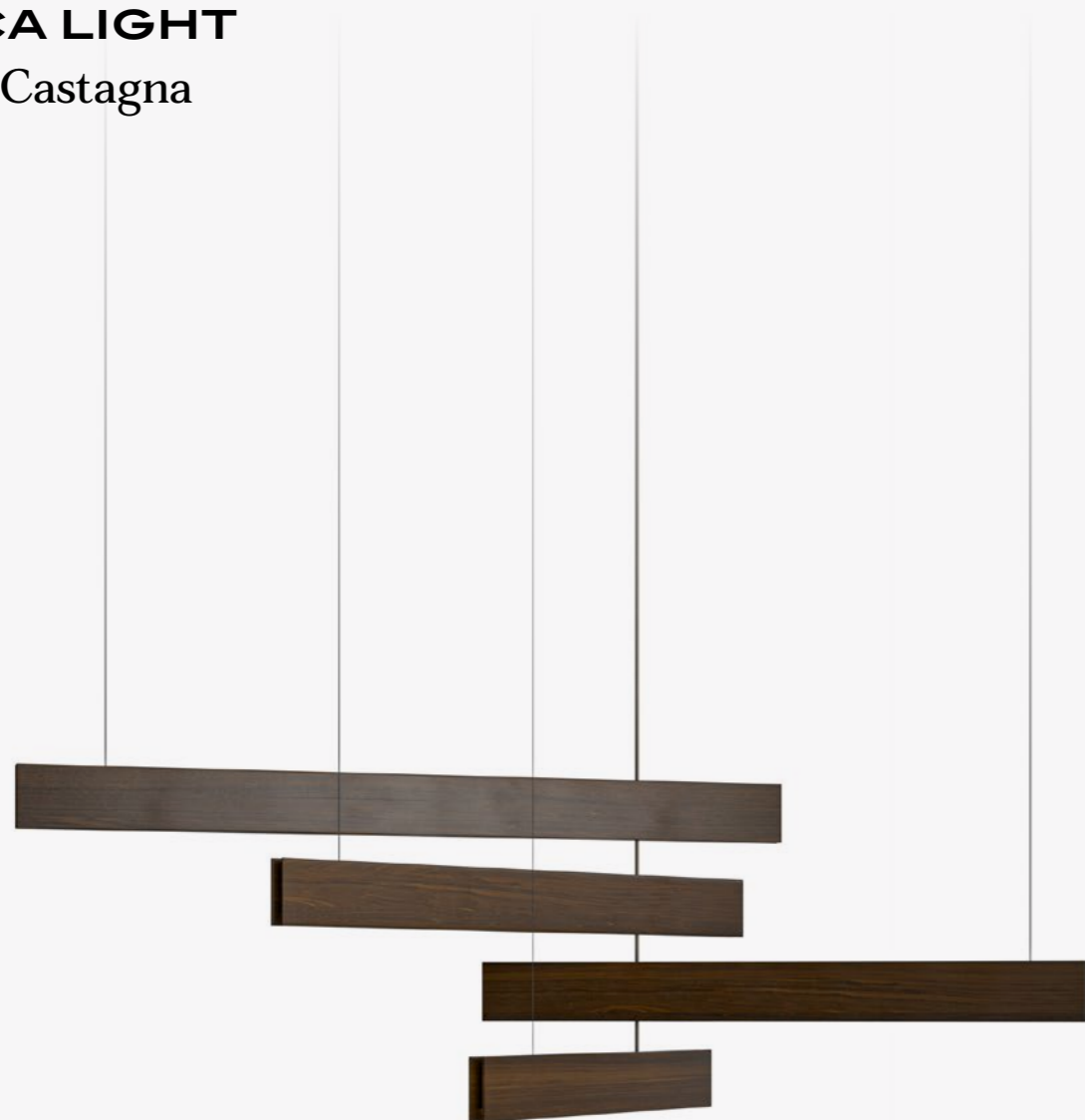

STRUCTURE	sapelli mahogany, stainless steel
HARDWARE	stainless steel
TOTAL POWER	83 Watt
PROTECTION GRADE.....	IP55
COLOR TEMPERATURE.....	3000 K

DIMENSIONS
150/240×10×140 cm

PP 26, 30, 69-70, 82,
85-87, 120-122, 124

EN Stecca is a striking lamp for tables or outdoor kitchens, made of four Sapelli mahogany modules hiding the light source. Adjustable blocks allow custom setups. Essential and elegant, it pairs with Exteta furniture.

IT Stecca è una lampada scenografica per tavolo o cucina outdoor, composta da quattro moduli in mogano Sapelli che celano la fonte luminosa. I blocchi orientabili permettono configurazioni personalizzate. Essenziale ed elegante, si abbina agli arredi Exteta.

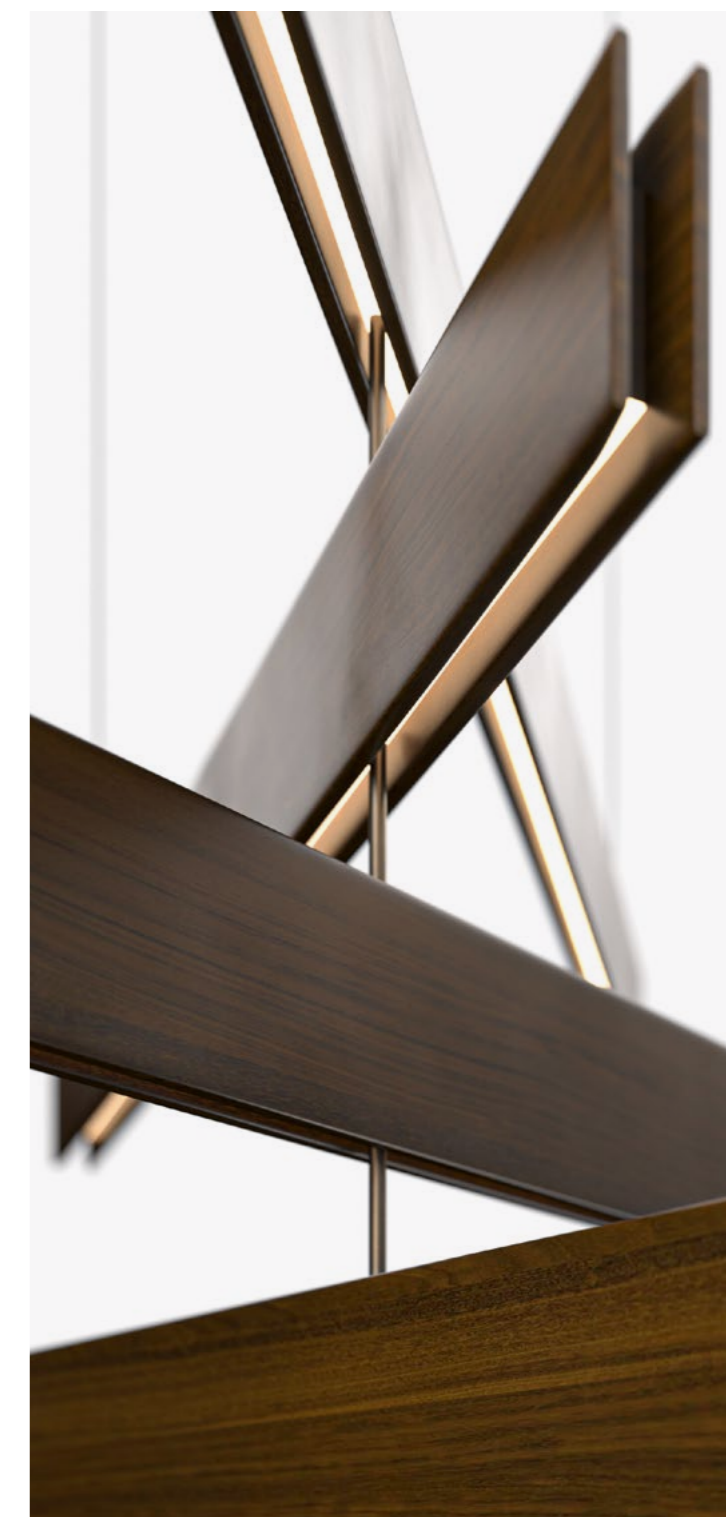

STECCA LIGHT APPLIQUE

Massimo Castagna



STRUCTURE sapelli mahogany and stainless steel
 PROTECTION GRADE.....IP55
 TOTAL POWER 24 W
 COLOR TEMPERATURE..... 3000 K

DIMENSIONS
5×25×205 cm

PP 58, 60, 66

EN Stecca Light Applique, by Massimo Castagna, is the wall version of the ceiling lamp. In Sapelli mahogany, with clean geometric lines, it brings discreet elegance and enhances the wood's natural grain.

IT Stecca Light Applique, firmata da Massimo Castagna, è la versione da parete della lampada da soffitto. In mogano Sapelli, con linea geometrica essenziale, illumina l'outdoor con eleganza discreta, valorizzando le venature naturali del legno.



STECCA LIGHT FREESTANDING

Massimo Castagna



STRUCTURE:..... sapelli mahogany and stainless steel
 PROTECTION GRADE.....IP55
 TOTAL POWER.....24 W
 COLOR TEMPERATURE.....3000 K

DIMENSIONS
 ø40×240 cm

PP 129, 131

EN In its freestanding version, the Stecca lamp highlights its linearity with a minimal base. Light flows from the central slit, casting reflections. Made of Sapelli mahogany, it fits indoors or outdoors.

IT Nella versione freestanding, la lampada Stecca accentua la sua linearità con una base essenziale che ne esalta la forma. La luce si diffonde dalla fenditura centrale, creando riflessi sull'ambiente. In mogano Sapelli, si adatta con naturalezza a interni ed esterni.

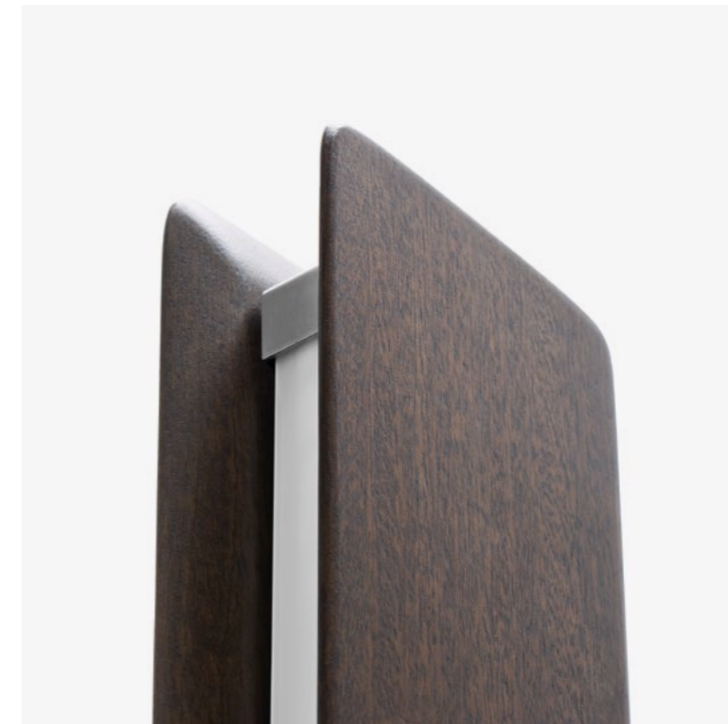
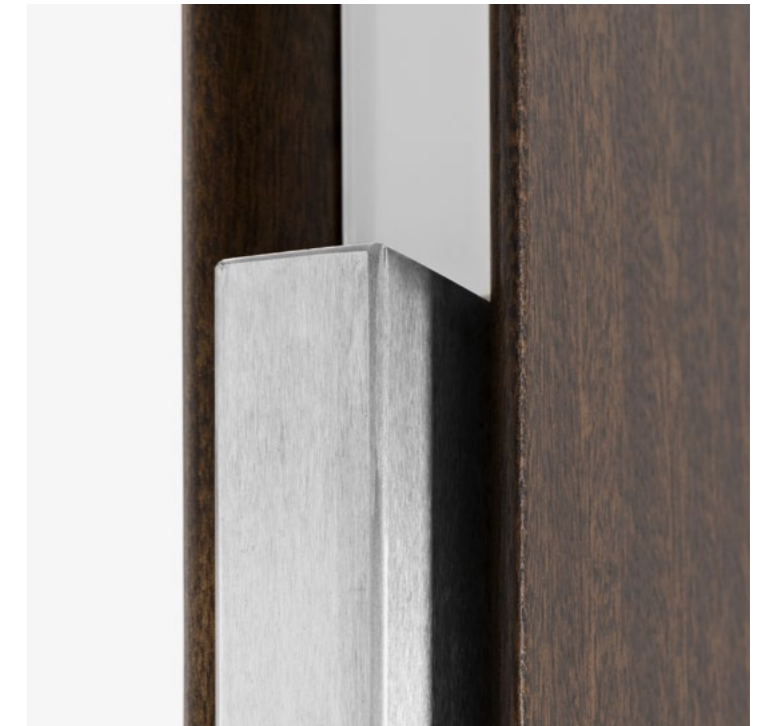

STONE ROUND COFFEE TABLE

Ludovica + Roberto Palomba



STRUCTUREmarble / stone

DIMENSIONS
 ø34×h30 cm / ø42×h54 cm
 / ø50×h40 cm

PP 10, 56, 98, 129

EN Signed by Ludovica + Roberto Palomba, this marble coffee table collection pays tribute to classical art with a contemporary touch. Exclusive finishes and bold tops create unique, simple yet elegant pieces.

IT Firmata da Ludovica + Roberto Palomba, questa collezione di tavolini in marmo è un omaggio all'arte classica in chiave contemporanea. Le finiture esclusive e il profilo spesso del piano creano pezzi unici, eleganti nella loro semplicità e ricchi di personalità.

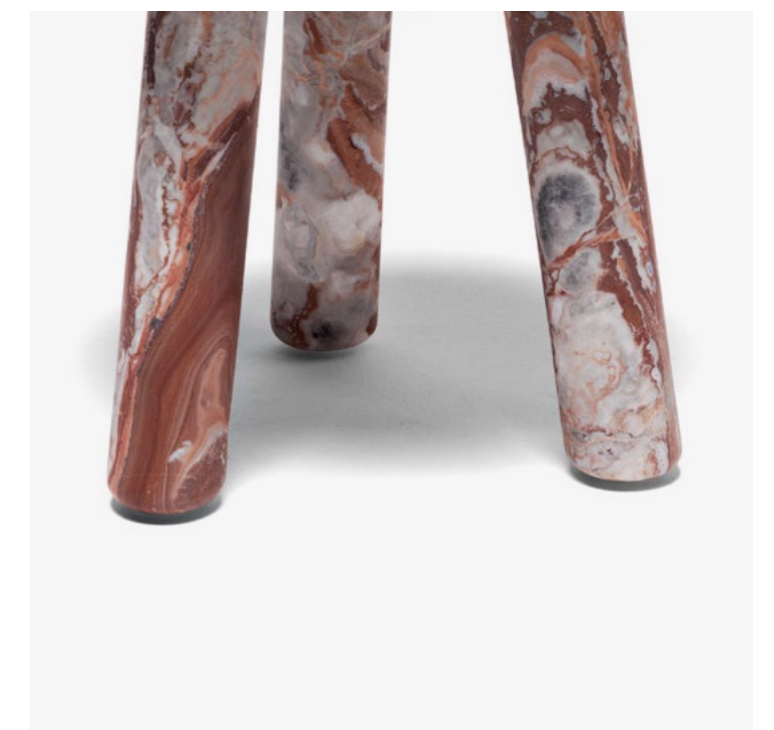
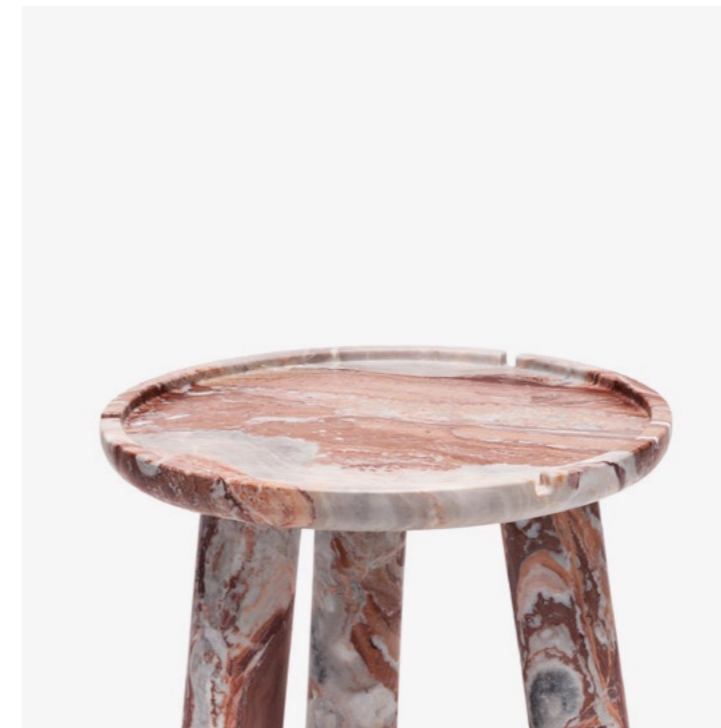

STRINGA ARMCHAIR 1963

Gae Aulenti



STRUCTURE stainless steel, heat-sealed straps, polyurethane foam at different densities
INTERNAL LINING waterproof and breathable fabrics
EXTERNAL LINING fabric or leather
FEET POM-C

DIMENSIONS

87×94×80 cm

PP 134, 137

EN With soft lines and '60s style, this Gae Aulenti armchair, reissued by Exteta, blends sensuality and comfort. Its stainless steel frame, in light gray or gunmetal finish, supports a wide padded seat upholstered in leather or fabric.

IT Con linee morbide e gusto anni '60, questa poltrona di Gae Aulenti, rieditata da Exteta, unisce sensualità e comfort. La struttura in acciaio inox, in finitura grigio chiaro o canna di fucile, sorregge un'ampia seduta imbottita, rivestita in pelle o tessuto.



STRINGA COFFEE TABLE 1963

Gae Aulenti



TOP..... sapelli mahogany
 STRUCTUREstainless steel
 FEET..... POM-C

DIMENSIONS

78x82x32 cm

PP 134-135, 137

EN Like the chairs in the collection, the Stringa Coffee Table features a stainless steel tubular frame supporting a mahogany top. The contrast between curved lines and square surface creates Gae Aulenti's timeless design, suitable for any indoor or outdoor space.

IT Come le sedute della collezione, il tavolino Stringa ha struttura tubolare in acciaio inox e piano in mogano. Il contrasto tra linee curve e superficie quadrata rende il design di Gae Aulenti senza tempo, adatto a ogni ambiente indoor e outdoor.

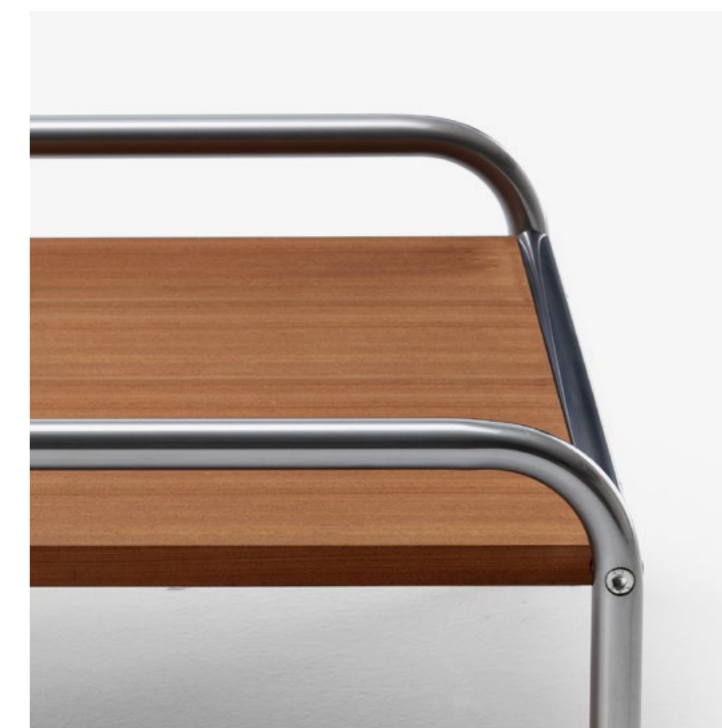

**STRINGA
SOFA 1963**
Gae Aulenti



STRUCTURE stainless steel, heat-sealed straps, polyurethane foam at different densities
INTERNAL LINING waterproof and breathable fabrics
EXTERNAL LINING fabric or leather
FEET POM-C

DIMENSIONS
153×94×80 cm / 228×94×80 cm

PP 134-137

EN The Stringa Sofa, a Gae Aulenti original reissued by Exteta, combines '60s style and comfort. With soft curves, a wide seat, and cushioned back, its tubular stainless steel structure lends an enveloping character, perfect for indoor and outdoor.

IT Il divano Stringa, progetto originale di Gae Aulenti rieditato da Exteta, unisce gusto anni '60 e comfort. Con curve dolci, seduta ampia e schienale morbido, la struttura tubolare in acciaio inox gli conferisce un carattere avvolgente, perfetto per indoor e outdoor.



SUNSET LOUNGE TABLE

Paola Navone OTTO Studio



TOP.....marble / stone
 STRUCTUREsapelli mahogany, stainless steel
 FEET..... powder coated aluminium, pvc

DIMENSIONS

ø120×h65/75 cm

PP 42, 53, 57

EN In the Sunset Lounge table, the round natural stone top dialogues with the turned wooden base, creating a playful 3D pattern. Soft lines and circular forms merge in a perfect piece for relaxed moments and social gatherings.

IT Nel tavolo Sunset Lounge, il piano rotondo in pietra naturale dialoga con la base in legno tornito, creando un pattern tridimensionale. Linee morbide e forme circolari si fondono in un complemento perfetto per ogni momento, da pause rilassate a incontri conviviali.



TERRA FRESCA CARPET

Deanna Comellini

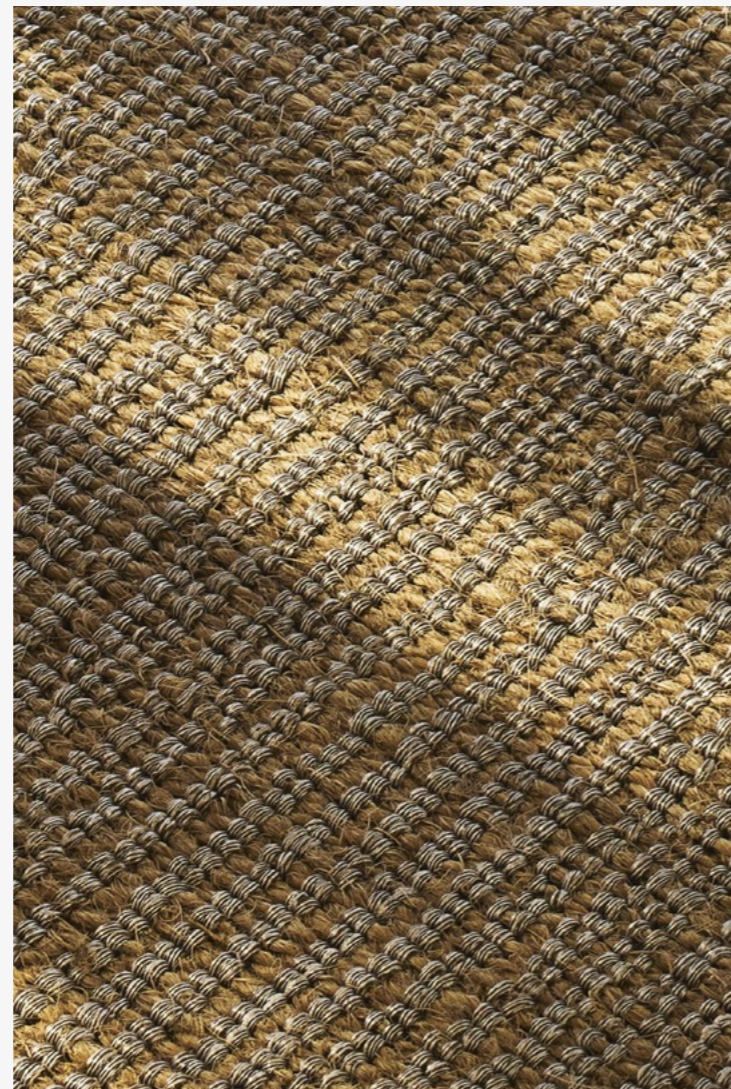

COMPOSITIONhandwoven coir fiber and polyester

DIMENSIONS
200x30 cm / 250x600 cm
/ 300x400 cm

PP 9, 31, 42-43, 48-55, 57,
67, 71, 78-83, 86-89, 93, 94,
100-107, 128-131, 134-135.

EN Deanna Comellini's carpet line, in coconut fiber and technical yarn, honors handweaving: durable, versatile, and unique thanks to the charm of irregularity.

IT La linea di tappeti di Deanna Comellini, in fibra di cocco e filato tecnico, celebra la tessitura a mano: resistente, versatile e unica grazie al fascino dell'irregolarità.



Materials

FABRICS

EN All fabrics are specifically selected for their quality, performance, and ease of cleaning. They are engineered to be resistant to agents such as water, salinity, sunlight, mold, stains, and high abrasions while limiting changes in their appearance, tactile qualities and color.

IT Tutti i tessuti sono accuratamente selezionati per la loro qualità, prestazioni e facilità di pulizia. Sono progettati per resistere ad agenti quali acqua, salsedine, luce solare, muffa, macchie e abrasioni intense, limitando al contempo eventuali alterazioni nell'aspetto, nella texture e nel colore.



Brea 04.....

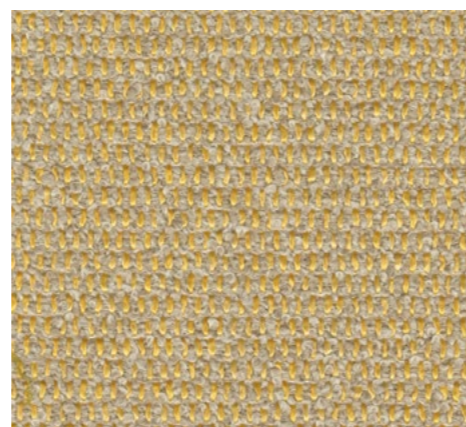

Brea 22.....



Tarascon 03.....

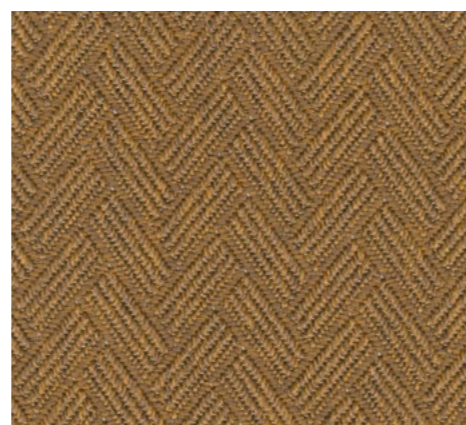

Vernon 79.....

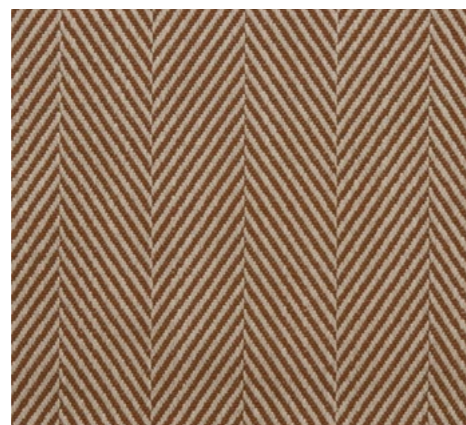

Loro Piana Dehors Eze Kasha Kummel 013



Loro Piana Dehors Grimaud Ginger 004 ...

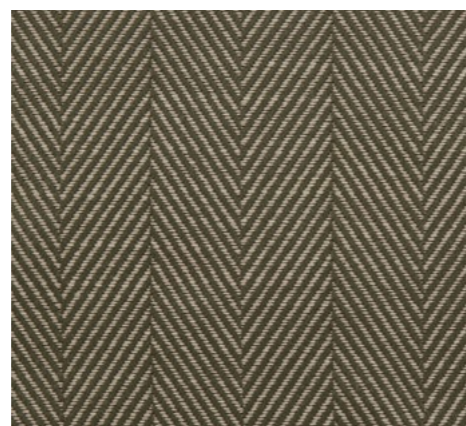

Loro Piana Dehors Eze Kasha Muschio 016

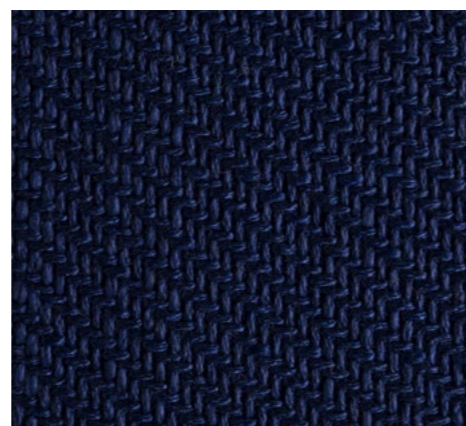

Loro Piana Dehors Grimaud Indigo 003.....

NOTES

Discover the complete selection of finishes on our website.

Scopri la selezione completa di finiture sul nostro sito.



Iseo 15.....



Lorkey 41.....



Tarascon 72.....

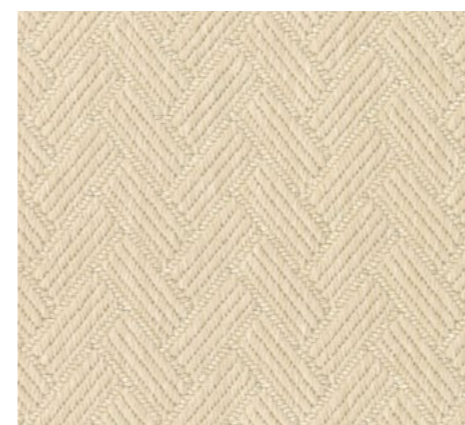

Vernon 04.....



Vargas 04.....



Vargas 01.....

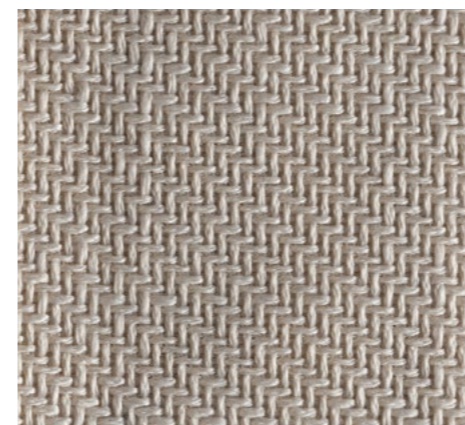

Loro Piana Dehors Grimaud Biancore 001

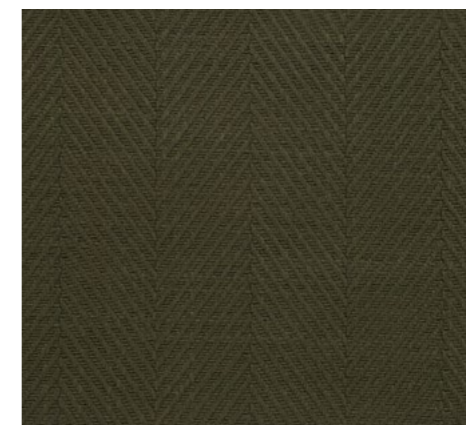

Loro Piana Dehors Eze Muschio 007.....



Loro Piana Dehors Eze Kasha Spago 012....



Loro Piana Dehors La Ponche Fieno 002...



Loro Piana Dehors Sabi Sands Shaded White 001.....



Loro Piana Dehors Sabi Sands Kasha 002

LEATHERS

EN Printed leather with uniform grain that is treated to resist atmospheric agents and marine environments. Depending on the production batches, the natural differences in the leather's color create a variety of unique aesthetic effects.

IT Pelle bovina stampata a grana uniforme, trattato per resistere agli agenti atmosferici e ambienti marini. A seconda dei lotti di produzione, le naturali variazioni cromatiche della pelle conferiscono effetti estetici unici e distintivi.

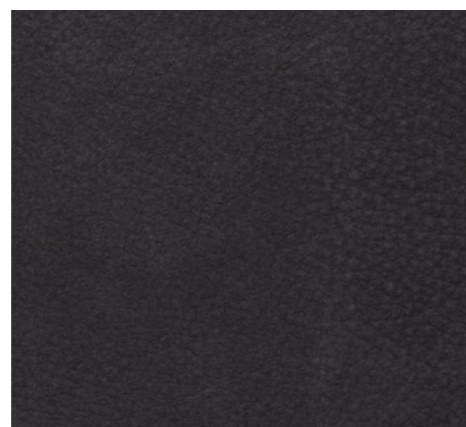

Nabuk Antracite



Nabuk Avorio



Nabuk Nocciola



Nabuk Noce

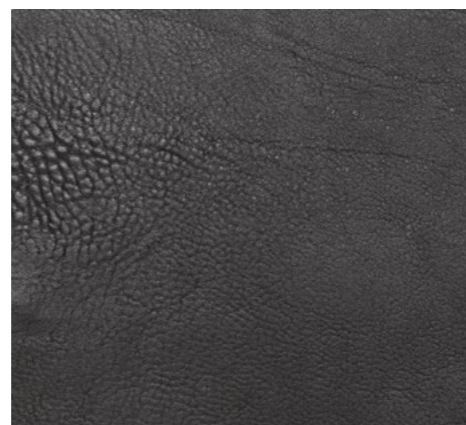

Saddle Leather Balena

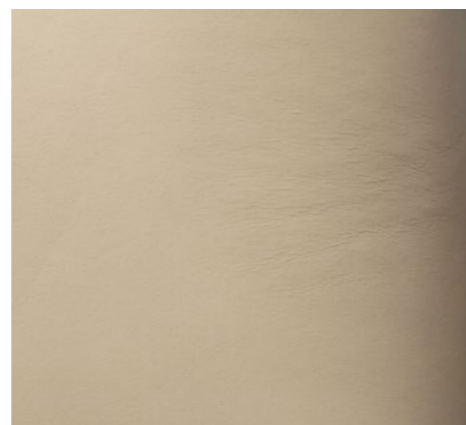

Saddle Leather Porcellana

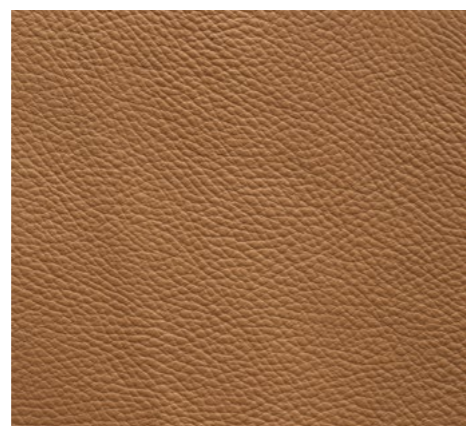

Shark S011

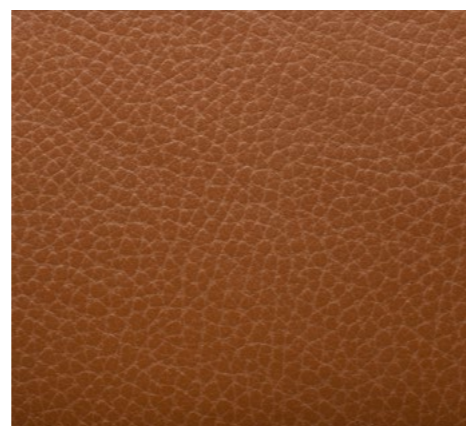

Shark S507

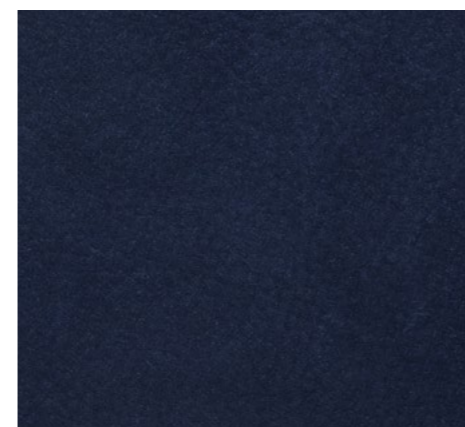

Nabuk Blu

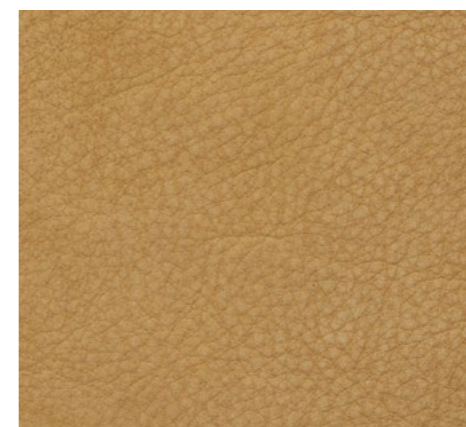

Nabuk Camoscio

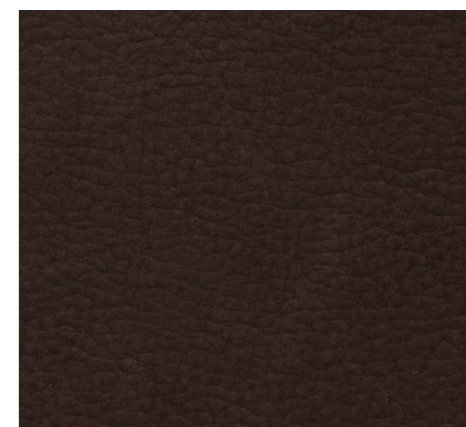

Nabuk Cioccolato



Nabuk Petrolio

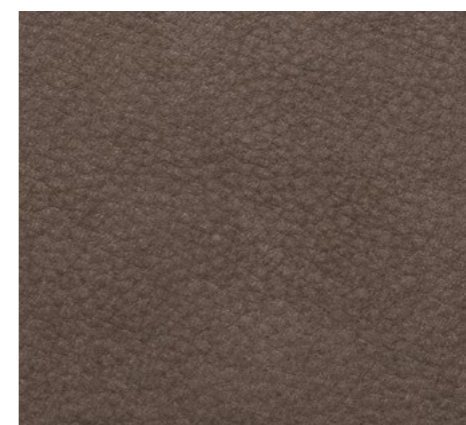

Nabuk Terra



Saddle Leather Atlantico

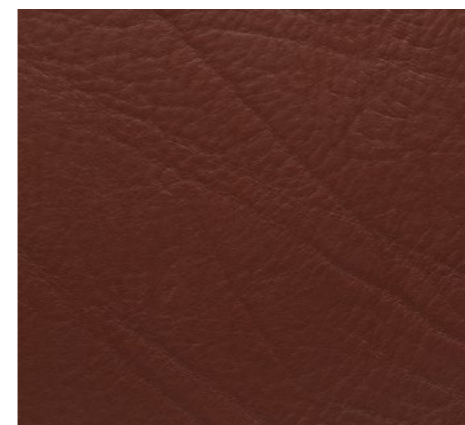

Saddle Leather Rovere

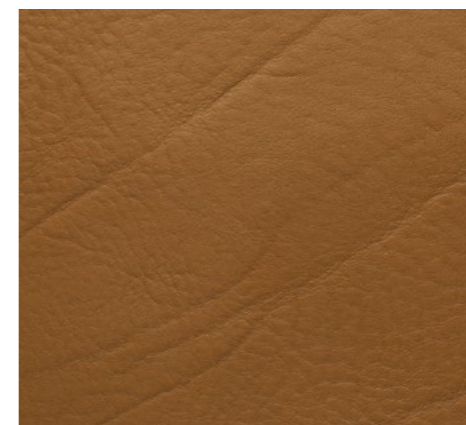

Saddle Leather Teak



Shark S480



Shark S518



Shark S524



Shark S542

NOTES

Discover the complete selection of finishes on our website.

Scopri la selezione completa di finiture sul nostro sito.

MARBLES & STONES

EN Exteta carefully selects natural marbles and stones to create unique surfaces, expressions of elegance and authenticity. Each slab is chosen for its distinctive veining and one-of-a-kind features, turning raw material into a signature element of style and refinement.

IT Exteta seleziona con cura marmi e pietre naturali per creare superfici uniche, espressione di eleganza e autenticità. Ogni lastra è scelta per le sue venature e caratteristiche irripetibili, trasformando la materia in un elemento distintivo di stile e raffinatezza.

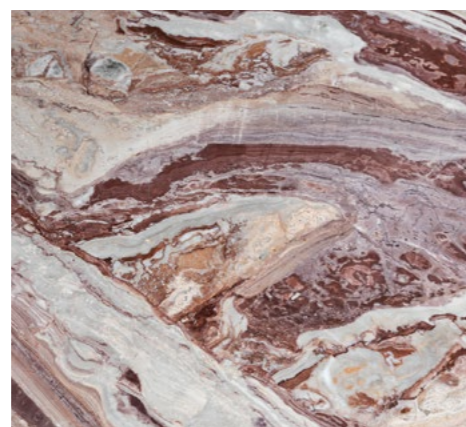

Arabescato Orobico Rosso

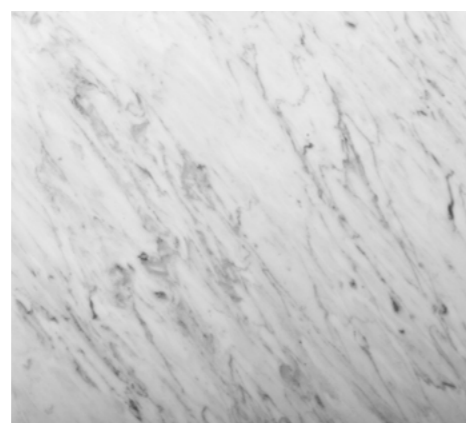

Carrara



Travertino Antico

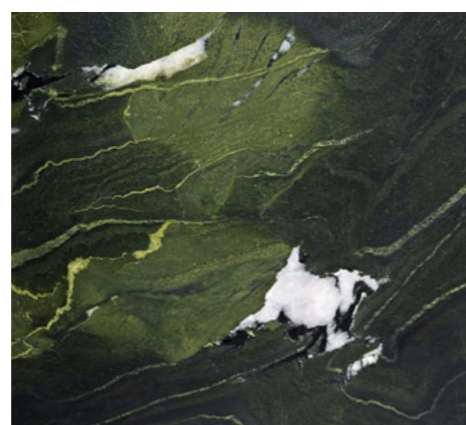

Quartzite Verde

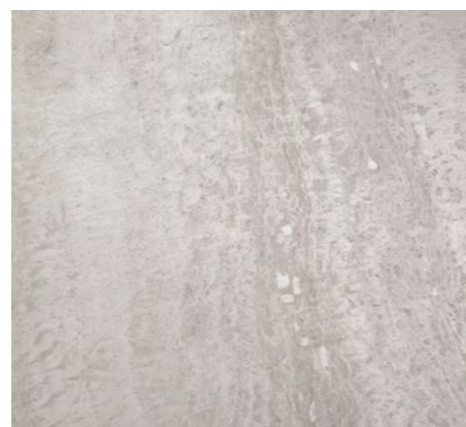

Ostuni

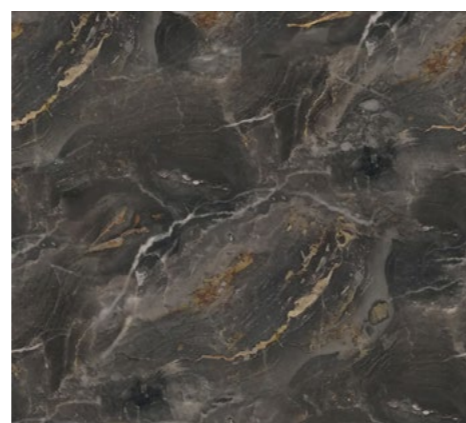

Steven Black



Porfido Viola



Sahara Grey

NOTES

Discover the complete selection of finishes on our website.

Scopri la selezione completa di finiture sul nostro sito.

METALS

EN Exteta blends refined metals like stainless steel, bronze, anticorodal aluminium, and burnished brass to enhance durability and elegance. Each material is chosen for its resistance, beauty, and ability to elevate design, embodying Italian craftsmanship and timeless allure.

IT Exteta utilizza metalli pregiati come acciaio inox, bronzo, alluminio anticorodal e ottone brunito per esaltare durabilità ed eleganza. Ogni materiale è selezionato per la sua resistenza, bellezza e capacità di valorizzare il design, incarnando l'eccellenza del saper fare italiano.



Anticorodal Aluminium



Bronze

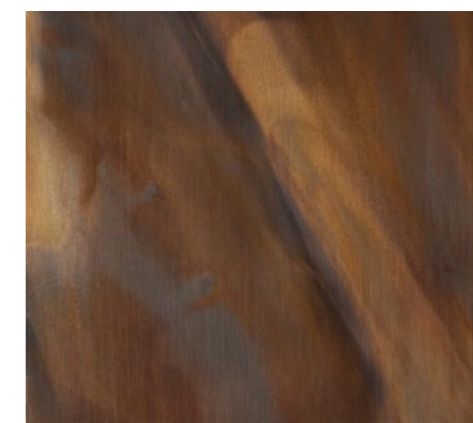

Burnished Brass

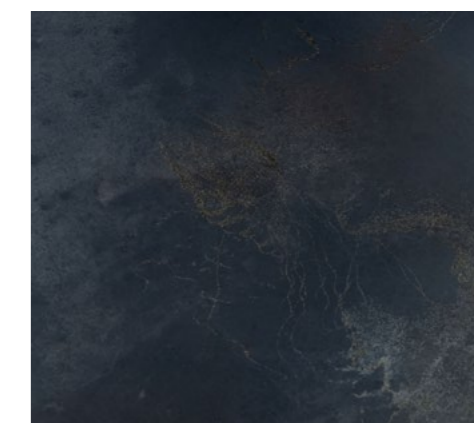

Storm

NATURAL MATERIALS

EN Exteta embraces natural materials like rush and rattan, celebrating their organic beauty and tactile warmth. Handcrafted with care, these elements bring a sense of harmony and authenticity, connecting design with nature through timeless Italian artistry.

IT Exteta valorizza materiali naturali come giunco e rattan, esaltandone la bellezza organica e il calore tattile. Lavorati a mano con cura, questi elementi trasmettono armonia e autenticità, unendo design e natura attraverso l'arte senza tempo del saper fare italiano.



Vimini Rossiccio

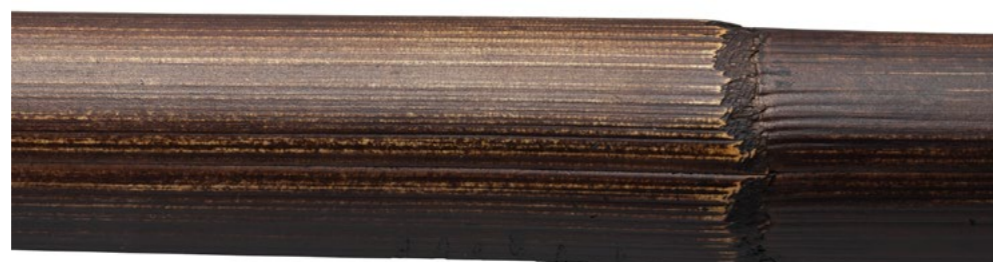

Giunco Barrique



Giunco Natural

WOOD

EN Sapelli mahogany wood, the finest of its kind, known for its exquisitely fine veining. Highly durable and perfect for outdoor settings, mahogany has a lengthy tradition of use yacht-building.

IT Mogano sapelli, il più pregiato nel suo genere, conosciuto per le sue venature squisitamente fini. Altamente resistente e perfetto per ambienti outdoor, il mogano ha una lunga tradizione di utilizzo nello yacht-building.

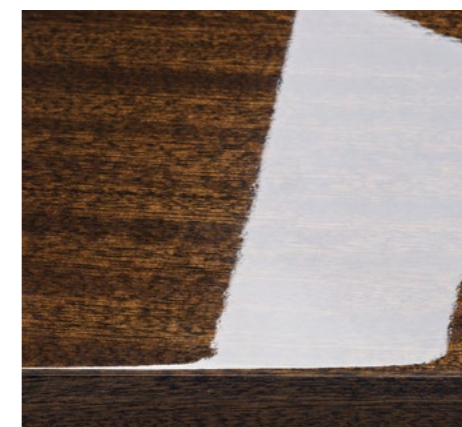

Lucido Mediterraneo Barrique

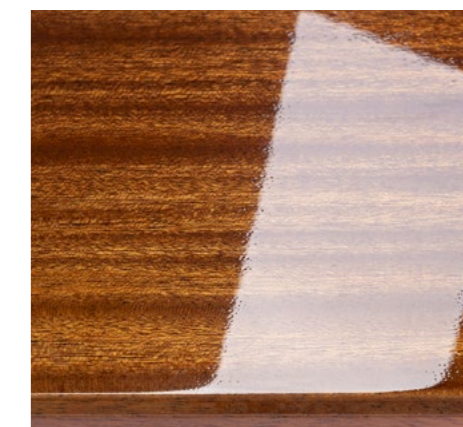

Lucido Mediterraneo Mahogany

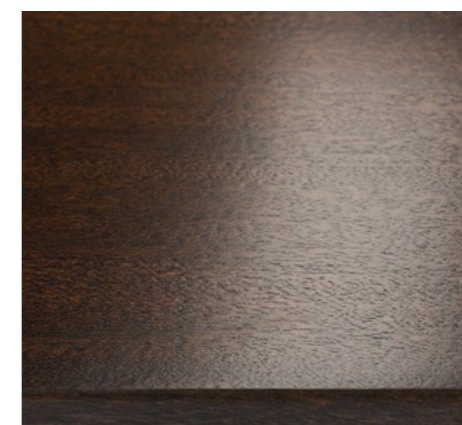

Matt Barrique

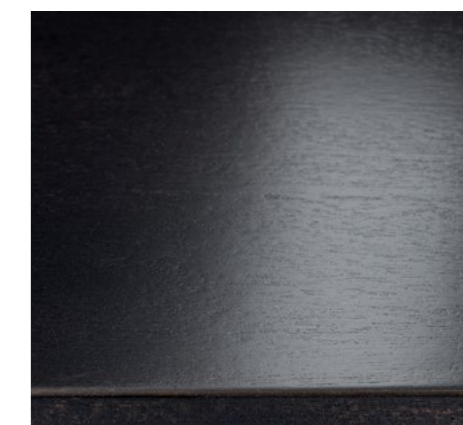

Matt Dark

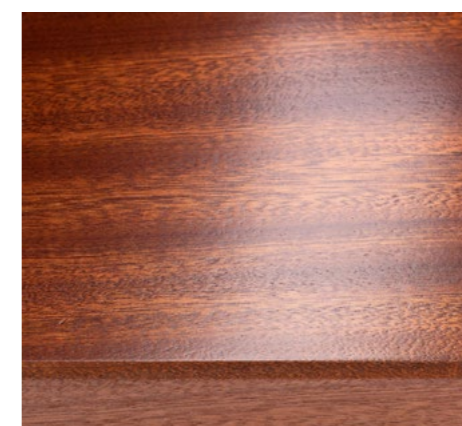

Matt Mahogany

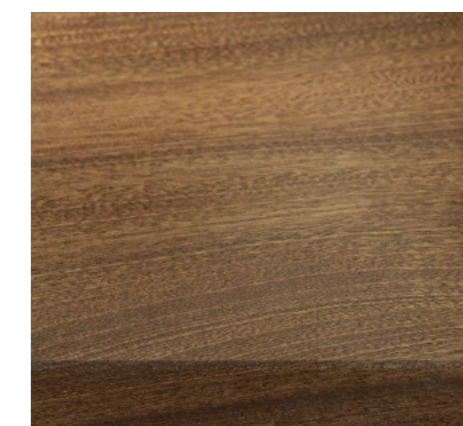

Untreated Natural Mahogany.....

10 TH JOINT STONE DINING TABLE	156
10 TH KITCHEN	158
10 TH PRATO FIORITO FLOOR LIGHT	160
10 TH STAR COFFEE TABLE	162
10 TH TELLARO SUN LOUNGER	164
AMALFI KITCHEN	166
ASTRATTO COFFEE TABLE	176
BISCUIT COFFEE TABLE	178
CAPRERA SOFA	180
EXTETA X RIVA ARMCHAIR	186
EXTETA X RIVA CHAIR	188
EXTETA X RIVA COFFEE TABLE	190
EXTETA X RIVA DINING TABLE	192
EXTETA X RIVA LAMP	194
EXTETA X RIVA LOUNGE TABLE	196
EXTETA X RIVA LOUNGE CHAIR	198
EXTETA X RIVA LOUNGE CHAIR WITH WOODEN ARMRESTS	200
EXTETA X RIVA SOFA	202
EXTETA X RIVA SOFA WITH WOODEN ARMRESTS	204
EXTETA X RIVA SUN LOUNGER	208
HIKARI LAMP	210
LEVANTE STOOL	212
LPIDC01 FOLDABLE DIRECTOR'S CHAIR	214
LPIDC02 ARMCHAIR	216
LPIDC03 FOLDABLE STOOL	218
LPIDC04 SUNBED	220
LPIDC05 ROCKING CHAIR	222
LPIDC06 DINING TABLE	224
LPIDC07 SIDE TABLE	226
LPIDC08 LOUNGE CHAIR	228
LPIDC08 SOFA	230
LPIDC09 WOODEN COFFEE TABLE	232
LPIDC10 COFFEE TABLE	234

LPIDC11 MODULAR SOFA	236
LPIDC12 DINING CHAIR	242
LPIDC13 BAR STOOL	244
LPIDC14 WOODEN DINING TABLE	246
LPIDC15 PORTABLE LAMP	248
MICHELANGELO DINNER TABLE	250
MOCHI ARMCHAIR	252
MOCHI CHAISE LONGUE	254
MOCHI SOFA	256
MODERNISTA ARMCHAIR	258
MODERNISTA CHAIR	260
MOONLIGHT DINING TABLE	262
MOONLIGHT SOFT CHAIR	264
NEREIDE BASKET	266
NO-GLUE ARMCHAIR	268
PANAREA COFFEE TABLE	270
PERISCOPIO ARMCHAIR	272
PERISCOPIO CHAISE LONGUE	274
PERISCOPIO COFFEE TABLE	276
PERISCOPIO SOFA	278
SERELE COFFEE TABLE	282
SHELL ARMCHAIR	284
SHELL CHAIR	286
STECCA LIGHT	288
STECCA LIGHT APPLIQUE	290
STECCA LIGHT FREESTANDING	292
STONE ROUND COFFEE TABLE	294
STRINGA ARMCHAIR 1963	296
STRINGA COFFEE TABLE 1963	298
STRINGA SOFA 1963	300
SUNSET LOUNGE TABLE	302
TERRA FRESCA CARPET	304

**EXTETA 2025
MASTER OF EXCELLENCE**

**CONCEPT
AND ART DIRECTION**
Studiopepe

PHOTOGRAPHY
PP 9-13, 26, 30-31,
40-71, 78-107, 115-137
Garage121

PP 15-16, 72-73,
108-109, 138-139,
156-167, 176-181,
186-205, 208-237,
242-279, 282-305
Francesco Bolis

PP 21, 24-25
Andrea Ferrari

PP 32-37
Theo de Guelztl

GRAPHIC DESIGN
Studio Blanco

Printed in Italy
Arti Grafiche Turati

