

MY YOUR®

ITALIAN OUTDOOR EXPERIENCE

OUTDOOR  
DESIGN+LIGHTS

MY YOUR®  
ITALIAN OUTDOOR EXPERIENCE

OUTDOOR DESIGN+LIGHTS



### L'outdoor experience, firmata MY YOUR: un'esperienza 100% italiana

Ci sono oggetti che non arredano soltanto, ma raccontano una storia. MY YOUR nasce da questa visione: un brand che, sin dalle origini, ha fatto del design per l'outdoor la sua firma distintiva. In queste pagine prende forma un racconto fatto di materia, luce e ricerca, dove ogni elemento è frutto di un sapere 100% Made in Italy, costruito su passione, competenza tecnica e una cura artigianale per ogni dettaglio.

Design+Lights è il catalogo che raccoglie i prodotti storici e iconici del marchio, quei progetti che hanno segnato l'inizio di un percorso e che ancora oggi incarnano l'essenza di MY YOUR. Sono le radici su cui il brand ha costruito il proprio know-how e su cui continua a investire, spingendosi oltre i confini della materia, attraverso nuove tecnologie. Finiture esclusive che fanno dimenticare la sensazione materica della plastica, trasformandosi in superfici sofisticate e vellutate al tatto, calde e accoglienti come il velluto, ma al tempo stesso resistenti agli agenti esterni. Una combinazione perfetta per ambienti eleganti e versatili, capaci di adattarsi a ogni stile e gusto.

Protagonisti sono arredi, complementi e lampade in Poleasy®, il materiale rivoluzionario evoluzione del polietilene, che assicura superfici facili da pulire e arredi più durevoli, mantenendo nel tempo una bellezza intatta, senza i micropuntini che caratterizzano il polietilene tradizionale quando si sporca o si usura. Accanto a questi, nascono nuove collezioni di sedute e tavoli in polipropilene, leggeri, resistenti, impilabili e versatili, progettati per unire stile e funzionalità e rispondere con eleganza alle esigenze del vivere contemporaneo. Tutte le collezioni sono progettate per resistere alle sfide dell'esterno: dalla salsedine all'umidità, dalle alte temperature al passare del tempo. MY YOUR realizza ogni prodotto 100% riciclabile, pensato per durare e per rispettare l'ambiente, nella convinzione di un domani più responsabile.

Design+Lights è il racconto di un'identità precisa, autentica, che coniuga tecnologia, design e sostenibilità. Un racconto fatto di forme che emozionano, di luci che accendono l'atmosfera, di materiali che ridefiniscono lo spazio.

### The outdoor experience, by MY YOUR: a 100% Italian experience

There are objects that not only furnish, but also tell a story. MY YOUR was born from this vision: a brand that, since its inception, has made outdoor design its distinctive signature. These pages tell a story of materials, light and research, where every element is the result of 100% Made in Italy expertise, built on passion, technical skill and artisan attention to every detail.

Design+Lights is the catalogue that brings together the brand's historic and iconic products, those projects that marked the beginning of a journey and still embody the essence of MY YOUR today. These are the roots on which the brand has built its know-how and continues to invest, pushing beyond the boundaries of materials through new technologies. Exclusive finishes that make you forget the material feel of plastic, transforming it into sophisticated surfaces that are velvety to the touch, warm and welcoming like velvet, but at the same time resistant to external agents. A perfect combination for elegant and versatile environments, capable of adapting to any style and taste.

The protagonists are furnishings, accessories and lamps in Poleasy®, the revolutionary evolution of polyethylene, which ensures easy-to-clean surfaces and more durable furnishings, maintaining their beauty intact over time, without the micro-dots that characterise traditional polyethylene when it gets dirty or worn. Alongside these, new collections of polypropylene chairs and tables have been created, which are lightweight, resistant, stackable and versatile, designed to combine style and functionality and respond elegantly to the needs of contemporary living.

All collections are designed to withstand the challenges of the outdoors: from salt to humidity, from high temperatures to the passage of time. MY YOUR manufactures every product to be 100% recyclable, designed to last and respect the environment, in the belief of a more responsible tomorrow.

Design+Lights is the story of a precise, authentic identity that combines technology, design and sustainability. A story made up of shapes that excite, lights that brighten the atmosphere, and materials that redefine space.

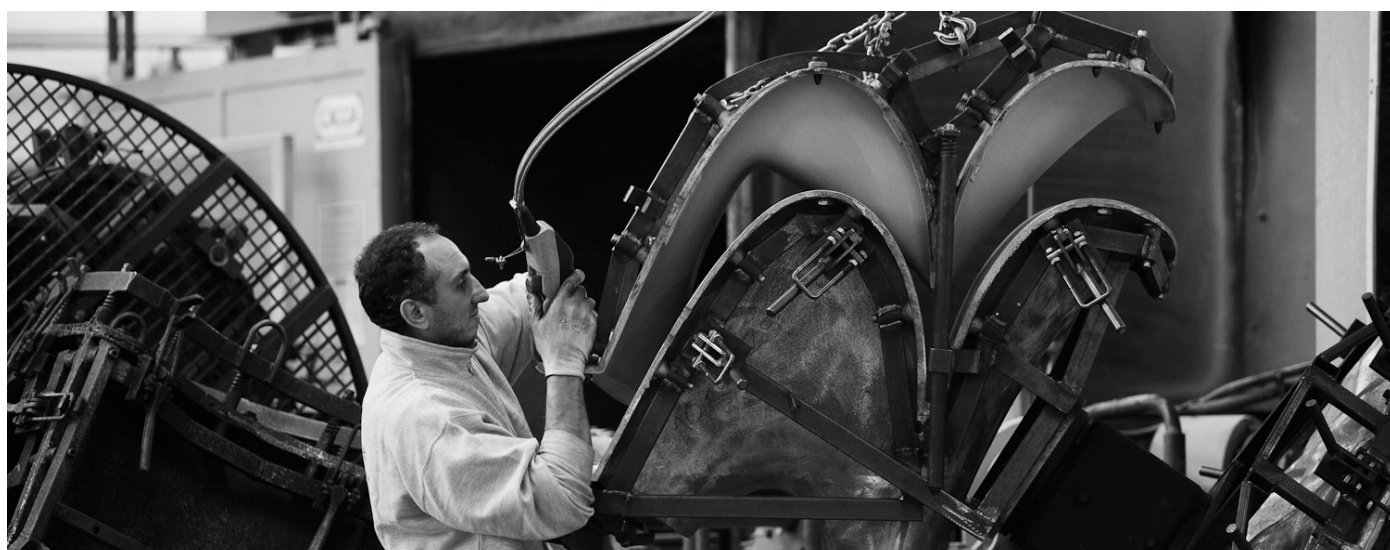

### Tradizione Italiana, Design Contemporaneo

MY YOUR nasce nel 2007 dall'esperienza della famiglia Ronco, che da oltre quarant'anni opera nella produzione conto terzi e nella lavorazione delle materie plastiche. Una storia che nasce dalla tradizione artigianale italiana e che, con il tempo, si è trasformata in un percorso di crescita fatto di passione, ricerca e innovazione.

Oggi, grazie a continui investimenti in nuove tecnologie, MY YOUR affianca agli arredi e alle lampade in Poleasy®, evoluzione del polietilene, facile da pulire e privo di micropori, nuove collezioni in polipropilene, in alluminio, arricchite da raffinate combinazioni con gres porcellanato, HPL e tessuti imbottiti.

Una proposta per l'arredo outdoor versatile e in costante evoluzione, capace di interpretare le tendenze del design contemporaneo e di rispondere alle esigenze di un mercato sempre più attento a estetica, funzionalità e sostenibilità. Grande attenzione è riservata anche alla ricerca di finiture esclusive, pensate per superare la percezione tradizionale della plastica: superfici che evocano il tatto del velluto, texture materiche e sofisticate che trasformano ogni elemento in un'esperienza sensoriale.

Nei propri stabilimenti in provincia di Padova, ogni progetto prende forma con la stessa cura e dedizione di sempre, dando vita ad arredi che racchiudono qualità, bellezza e autenticità 100% Made in Italy. Nulla è lasciato al caso: MY YOUR progetta, industrializza e produce internamente ogni collezione, seguendo ogni fase con lo stesso spirito artigianale che accompagna l'azienda fin dalle origini. Persino parte della minuteria viene realizzata internamente, a conferma di una cura che coinvolge ogni singolo dettaglio.

### Il valore delle mani

Gran parte delle lavorazioni è ancora affidata alla precisione delle mani esperte: dal controllo qualità alle finiture, fino alle cuciture. MY YOUR porta avanti una filosofia produttiva fondata sul rispetto e sulla valorizzazione del territorio, affidando a professionisti del territorio alcune lavorazioni esterne, come imbottiture e verniciature, in un dialogo continuo che garantisce standard elevati e contribuisce a preservare il patrimonio artigianale italiano.

### Il valore dei materiali, la forza del Made in Italy

Ogni collezione MY YOUR nasce dalla selezione di materiali italiani di eccellenza: metalli di qualità, gres, HPL, polipropilene, tessuti provenienti dalle migliori manifatture del Paese e l'esclusiva polvere di Poleasy®. Ogni scelta è guidata dal desiderio di coniugare bellezza, resistenza e responsabilità, per creare prodotti destinati a durare nel tempo e rispettare l'ambiente. Tutti i materiali utilizzati sono completamente riciclabili, a conferma dell'impegno dell'azienda verso una produzione consapevole e sostenibile. Ogni collezione MY YOUR nasce da una visione chiara: trasformare la materia in emozione facendo vivere ogni momento all'aperto come una vera Outdoor Experience.



#### Italian Tradition, Contemporary Design

MY YOUR was founded in 2007 by the Ronco family, who have been working in the third party production and plastics processing for over forty years. A story that began with Italian craftsmanship and, over time, has evolved into a journey of growth fuelled by passion, research and innovation.

Today, thanks to continuous investment in new technologies, MY YOUR combines furniture and lamps in Poleasy®, an evolution of polyethylene that is easy to clean and free of micropores, with new collections in polypropylene and aluminium, enriched by refined combinations with porcelain stoneware, HPL and upholstered fabrics. A versatile and constantly evolving outdoor furniture range, capable of interpreting contemporary design trends and responding to the needs of a market that is increasingly attentive to aesthetics, functionality and sustainability. Great attention is also paid to the search for exclusive finishes, designed to overcome the traditional perception of plastic: surfaces that evoke the feel of velvet, sophisticated textures that transform each element into a sensory experience.

In its factories in the province of Padua, each project takes shape with the same care and dedication as always, giving life to furniture that embodies quality, beauty and authenticity that is 100% Made in Italy. Nothing is left to chance: MY YOUR designs, industrialises and manufactures each collection in-house, following each stage with the same artisan spirit that has accompanied the company since its inception. Even the small parts are made in-house, confirming the attention to every single detail.

#### The value of craftsmanship

Much of the work is still entrusted to the precision of expert hands: from quality control to finishing touches and stitching. MY YOUR pursues a production philosophy based on respect for and promotion of the local area, entrusting certain external processes, such as padding and painting, to local professionals, in a continuous dialogue that guarantees high standards and helps to preserve Italy's artisan heritage.

#### The value of materials, the strength of Made in Italy

Each MY YOUR collection is created from a selection of excellent Italian materials: high-quality metals, stoneware, HPL, polypropylene, fabrics from the best manufacturers in the country and the exclusive Poleasy® powder. Every choice is guided by the desire to combine beauty, durability and responsibility, to create products that are designed to last and respect the environment. All the materials used are completely recyclable, confirming the company's commitment to conscious and sustainable production. Every MY YOUR collection is born from a clear vision: to transform matter into emotion, making every moment outdoors a true Outdoor Experience.

# INDEX

## BY CATEGORY

### Divani e poltrone Sofas and armchairs

CHICO	96
IRIS	120
LILY	112
MODI'	116
NOVA SET	104
SAMURAI	88

### Lettini Sunbeds

CLOE	142
ZOE	148

### Docce Showers

DYNO	152
------	-----

### Vasi Pots

GEM	154
PANDORA POTS	158
SKIN	162
TAO	166

### Sedute Seats

ADA	44
COMMUNITY SET RHONDA	126
EMMA	16
KAREN	24
LIBERTY	136
MR LEM	130
OXFORD	140
PAOLA	30
PANDORA	132
SOFIA	36
TINA	50

### Banconi Counters

BARAONDA	80
DUBLIN	72
NOVA BAR	64
VALE	58

### Separatori Dividers

BA_GIGIO	174
FLAMINGO	178
FRAMES	170

### Tavoli Tables

COMMUNITY SET TEDDY	126
LIBERTY	136
OXFORD	140

### Complementi Accessories

CRAZY HEAD	182
TINO	180

### Indice luci Light Index

### Indice tecnico Tech index

### Indice tecnico luci Lights tech index

# INDEX

BY COLLECTION

ADA	44	MODI'	122
BA_GIGIO	180	MR LEM	136
BARAONDA	86	NOVA BAR	70
CHICO	102	NOVA SET	110
CLOE	148	OXFORD	146
COMMUNITY SET	132	PAOLA	30
CRAZY HEAD	188	PANDORA	138
DUBLIN	78	PANDORA POTS	184
DYNO	158	SAMURAI	94
EMMA	16	SKIN	168
FLAMINGO	184	SOFIA	36
FRAMES	176	TAO	172
GEM	160	TINA	50
IRIS	126	TINO	186
KAREN	24	VALE	64
LIBERTY	142	VITO	58
LILY	112	ZOE	154



# POLEASY® e VELVET

Innovazione che vive negli spazi esterni

Ogni arredo MY YOUR nasce da una visione: trasformare la conoscenza delle materie plastiche in emozione, la tecnica in bellezza, la ricerca in innovazione continua. Non semplici oggetti, ma forme che resistono al tempo e agli elementi, capaci di portare all'esterno un'estetica sempre nuova e differente. È da questo percorso che prende vita Poleasy®, l'evoluzione del polietilene.

Un materiale che supera i limiti del passato: pur mantenendosi leggermente ruvido al tatto, elimina il problema della porosità tipica dei polimeri tradizionali. Grazie a questa rivoluzione, la superficie non assorbe impurità e quindi non si formano quei piccoli puntini neri che compromettono l'estetica e la percezione della qualità. Rimane la certezza di un arredo che, con la giusta cura, conserva la sua bellezza nel tempo.

A rendere MY YOUR unica nel suo linguaggio è la finitura VELVET. Frutto di continua ricerca e profonda conoscenza del materiale, VELVET trasforma il polietilene, spesso percepito come freddo e poco pregiato, in arredi e complementi vellutati, eleganti e accoglienti, capaci di invitare al tatto e di vivere con naturalezza diversi tipi di spazi esterni.

Innovation thriving in outdoor spaces

Every MY YOUR furnishing is born from a vision: transforming knowledge of plastics into emotion, technique into beauty, and research into continuous innovation. Not just simple objects, but shapes that withstand time and the elements, capable of bringing to the outdoors an ever-new and distinctive aesthetic. From this path comes Poleasy®, the evolution of polyethylene.

A material that goes beyond the limits of the past: while remaining slightly rough to the touch, it eliminates the problem of porosity typical of traditional polymers. Thanks to this revolution, the surface does not absorb impurities, preventing the formation of those small black dots that compromise aesthetics and the perception of quality. The certainty remains of a furnishing that, with proper care, retains its beauty over time.

What makes MY YOUR unique in its language is the VELVET finish. The result of continuous research and deep knowledge of the material, VELVET transforms polyethylene—often perceived as cold and of little value—into velvety, elegant, and welcoming furnishings and accessories, inviting to the touch and naturally suited to a variety of outdoor spaces.



# EMMA

Emma, disponibile in versione sedia e sgabello in quattro colori, fonde funzionalità e leggerezza in un design essenziale e moderno, perfetto per ogni ambiente, dal residenziale al contract. Realizzata in polipropilene riciclabile tramite stampaggio ad iniezione e 100% Made in Italy, garantisce resistenza, facilità di gestione e praticità anche grazie alla sua impilabilità. I piedini antiscivolo intercambiabili assicurano stabilità su ogni superficie. Le sue linee pulite e minimaliste portano una naturale eleganza, capace di valorizzare ogni spazio con un tocco di stile.

Emma, available as a chair and stool in four colours, combines functionality and lightness in a simple, modern design that is perfect for any setting, from residential to contract. Made from recyclable polypropylene using injection moulding and 100% Made in Italy, it guarantees durability, ease of use and practicality, thanks in part to its stackability. Interchangeable non-slip feet ensure stability on any surface. Its clean, minimalist lines bring a natural elegance, enhancing any space with a touch of style.





Emma sedie, Mimi mini contract (catalogo Soft+Alu)  
Emma chairs, Mimi contract mini (Soft+Alu catalogue)



Emma sedie e sgabelli, Maja tavolo da pranzo  
Emma chairs and stools, Maja dining table





Emma sgabelli, Oxford tavoli  
Emma stools, Oxford tables

# KAREN

Karen è la collezione outdoor che coniuga linee essenziali e funzionalità, pensata per arredare con stile ogni ambiente. Disponibile in versione sedia con o senza braccioli, e sgabello, si distingue per la struttura in metallo trattato per l'uso esterno e per la scocca in polipropilene riciclabile stampato ad iniezione, leggera, robusta e di facile manutenzione. I piedini antiscivolo intercambiabili assicurano stabilità su ogni superficie. Le sue forme pulite e i diversi colori disponibili la rendono ideale per contesti residenziali e contract. Impilabile, pratica e contemporanea, Karen è la soluzione perfetta per chi desidera un arredo outdoor versatile e durevole, senza rinunciare al design e di manifattura 100% Made in Italy.

Karen is the outdoor collection that combines clean lines and functionality, designed to furnish any environment with style. Available as a chair with or without armrests, and as a stool, it stands out for its metal frame treated for outdoor use and its lightweight, sturdy and easy-to-maintain injection-moulded recyclable polypropylene shell. Interchangeable non-slip feet ensure stability on any surface. Its clean lines and range of colours make it ideal for residential and contract settings. Stackable, practical and contemporary, Karen is the perfect solution for those who want versatile and durable outdoor furniture without compromising on design and 100% Made in Italy manufacturing.





Karen sedie e sgabelli  
Karen chairs and stools



Karen sedie con braccioli, Maja tavolo  
Karen chairs with armrests, Maja table



Karen sgabelli  
Karen stools

# PAOLA

Paola è la poltroncina a pozzetto stampato ad iniezione che avvolge con eleganza e che unisce comfort, stile e versatilità in un'unica forma accogliente. Disponibile in diversi colori, può essere scelta in versione monocolora oppure con gambe in fibra di legno, per un tocco più caldo e naturale. Ad impreziosirne l'estetica, la finitura effetto velluto sulla parte esterna della scocca, che dona raffinatezza e personalità. Realizzata in polipropilene riciclabile e 100% Made in Italy, è ideale per ambienti residenziali e contract. Il cuscino optional sfoderabile completa la seduta con un dettaglio raffinato. I piedini antiscivolo intercambiabili assicurano stabilità su ogni superficie. PAOLA è la scelta perfetta per chi cerca una poltroncina che unisce design contemporaneo e comfort avvolgente.

Paola is an injection-moulded bucket seat that elegantly envelops the user, combining comfort, style and versatility in a single welcoming form. Available in a range of colours, it can be chosen in a single colour or with wood fibre legs for a warmer, more natural touch. Its appearance is enhanced by the velvet-effect finish on the outside of the shell, which adds refinement and personality. Made of recyclable polypropylene and 100% Made in Italy, it is ideal for residential and contract environments. The optional removable cushion completes the seat with a refined detail. Interchangeable non-slip feet ensure stability on any surface. PAOLA is the perfect choice for those looking for an armchair that combines contemporary design and enveloping comfort.





Paola poltroncine  
Paola armchairs



Paola poltroncine con cuscini, Mimi tavolo da pranzo  
Paola armchairs with cushions, Mimi dining table



# SOFIA

La poltroncina Sofia nasce dal perfetto equilibrio tra design, comfort e funzionalità. Realizzata in polipropilene riciclabile stampato ad iniezione, si distingue per la sua anima versatile: ideale tanto per ambienti contract quanto per spazi residenziali. Sofia è disponibile in numerosi colori, in versione monocolore, bicolore scegliendo tra gambe in bianco, nero o in fibra di legno, combinabili con la scocca della seduta o in finitura Velvet, che conferisce una piacevole sensazione vellutata alla seduta esterna. I piedini antiscivolo intercambiabili assicurano stabilità su ogni superficie. Per chi desidera il massimo del comfort, sono disponibili due cuscini, uno integrato e uno appoggiato, oltre a una versione rivestita, perfetta per ambienti che richiedono un tocco ancora più accogliente.

Sofia è più di una seduta: è una proposta di stile, pensata per chi cerca un prodotto pratico, raffinato, di design e 100% Made in Italy.

The Sofia armchair is the result of a perfect balance between design, comfort and functionality. Made of recyclable injection-moulded polypropylene, it stands out for its versatility: ideal for both contract and residential spaces. Sofia is available in numerous colours, in single-colour or two-colour versions, with a choice of white, black or wood fibre legs, which can be combined with the seat shell or in a Velvet finish, which gives the outer seat a pleasant velvety feel. Interchangeable non-slip feet ensure stability on any surface. For those who want maximum comfort, two cushions are available, one integrated and one placed on top, as well as a covered version, perfect for environments that require an even more welcoming touch. Sofia is more than just a chair: it is a style proposal, designed for those looking for a practical, refined, designer product that is 100% Made in Italy.





Mimi tavoli contract 3 razze con piano 79x79, Sofia poltroncina da pranzo  
Mimi 3 spokes contract table with 79x79 top, Sofia dining armchairs



Sofia poltroncina in finitura velvet e cuscino integrato  
Sofia armchair in velvet finishing and integrated cushion



Sofia poltroncina in finitura velvet e cuscino integrato, Mimi tavolo contract  
Sofia armchair in velvet finishing and integrated cushion, Mimi contract table



Sofia poltroncina rivestita  
Sofia upholstered armchair



# ADA

La sedia Ada si distingue per la sua linea pulita ed essenziale, progettata per adattarsi con armonia sia agli ambienti contract che a quelli residenziali. Disponibile con o senza braccioli, è realizzata in polipropilene riciclabile tramite stampaggio a iniezione. Impilabile fino a 7 pezzi, Ada è una soluzione funzionale che ottimizza lo spazio senza rinunciare allo stile. I piedini antiscivolo intercambiabili assicurano stabilità su ogni superficie. Proposta in cinque colori e in versione Velvet, con schienale esterno effetto velluto, Ada aggiunge un tocco di raffinatezza tattile e visiva. La sua versatilità consente infinite combinazioni, rendendola perfetta per progetti d'arredo contemporanei e personalizzati. Ada è la sintesi ideale tra design, funzionalità e qualità 100% Made in Italy.

The Ada chair stands out for its clean, minimalist lines, designed to blend harmoniously into both contract and residential settings. Available with or without armrests, it is made of recyclable polypropylene using injection moulding. Stackable up to 7 pieces, Ada is a functional solution that optimises space without compromising on style. Interchangeable non-slip feet ensure stability on any surface. Available in five colours and in a Velvet version, with a velvet-effect external backrest, Ada adds a touch of tactile and visual refinement. Its versatility allows for endless combinations, making it perfect for contemporary and customised furnishing projects. Ada is the ideal synthesis of design, functionality and 100% Made in Italy quality.





Ada sedie con braccioli, Maja tavolo da pranzo con piano in doghe di alluminio  
Ada chairs with armrests, Maja dining table with aluminum slats top and Maja chairs



Ada sedie con e senza braccioli in finitura in velvet  
 Ada chairs with and without armrests in velvet finishing



Ada sedie, Mimi tavolo contract  
 Ada chairs, Mimi contract table

# TINA

La collezione Tina, composta da sedie con e senza braccioli e da uno sgabello, è un esempio di design semplice ed elegante. Realizzata in polipropilene riciclabile stampata ad iniezione e disponibile in diversi colori, è progettata per adattarsi con versatilità a molteplici contesti, sia in ambienti domestici che in spazi pubblici, grazie alle sue linee pulite ed essenziali e alla sua impilabilità. I piedini antiscivolo intercambiabili assicurano stabilità su ogni superficie. La collezione Tina rappresenta una scelta pratica e funzionale, ideale per chi cerca comfort e stile in un'unica soluzione 100% Made in Italy.

The Tina collection, consisting of chairs with and without armrests and a stool, is an example of simple and elegant design. Made of recyclable injection-moulded polypropylene and available in different colours, it is designed to adapt versatilely to multiple contexts, both in domestic environments and public spaces, thanks to its clean and essential lines and its stackability. Interchangeable non-slip feet ensure stability on any surface. The Tina collection is a practical and functional choice, ideal for those seeking comfort and style in a single 100% Made in Italy solution.





Tina sedie con e senza braccioli, Maja tavoli contract  
Tina chairs with and without armrests, Maja coffee tables



Tina sedia con braccioli, Maja tavolo contract  
Tina chairs with armrests, Maja contract table





Tina sedia, Teddy tavolo  
Tina chair, Teddy table



Tina sedie con e senza braccioli, Tina sgabello  
Tina chair with and without armrests, Tina stool

# V A L E

Vale è un bancone monoblocco polifunzionale che si adatta a molteplici utilizzi: bancone bar, postazione reception o elemento di servizio. È ideale per arredare con stile e funzionalità diversi tipi di spazio. Realizzato in Poleasy®, un'evoluzione del polietilene, è progettato per offrire elevata resistenza agli agenti atmosferici e una pulizia semplice e rapida, risultando perfetto per un uso professionale e intensivo. È disponibile in versione luminosa, predisposto per un kit luce con 3 lampadine ad attacco E27, oppure con una raffinata finitura effetto velluto. Utilizzabile singolarmente o in moduli affiancati, Vale offre infinite possibilità di configurazione, adattandosi con flessibilità alle esigenze di eventi, locali, hotel e spazi contract. Funzionalità, durabilità e design si fondono in un unico prodotto capace di valorizzare qualsiasi ambiente con presenza scenica e praticità.

Vale is a multifunctional monobloc counter that adapts to multiple uses: bar counter, reception desk or service element. It is ideal for furnishing different types of spaces with style and functionality. Made of Poleasy®, an evolution of polyethylene, it is designed to offer high resistance to atmospheric agents and quick and easy cleaning, making it perfect for professional and intensive use. It is available in a luminous version, designed for a light kit with 3 E27 bulbs, or with a refined velvet-effect finish. Vale can be used individually or in side-by-side modules, offering endless configuration possibilities and adapting flexibly to the needs of events, venues, hotels and contract spaces. Functionality, durability and design come together in a single product capable of enhancing any environment with its striking appearance and practicality.





Vale bancone, Cloe lettino  
Vale counter, Cloe sunbed



Vale bancone  
Vale counter

# NOVA BAR

Nova Bar si distingue per un design minimale, ammorbidito nella parte frontale convessa, che ne alleggerisce la presenza visiva e ne conferisce un'eleganza sobria e contemporanea. Questa leggerezza formale lo rende un elemento estremamente versatile, capace di integrarsi armoniosamente in qualsiasi ambiente. Il suo punto di forza risiede nei fianchi richiudibili che sostengono il piano in polietilene nel modulo lineare: una soluzione progettuale che permette di agganciare il piano direttamente alla struttura, facilitando il trasporto, ottimizzando lo spazio e migliorandone la maneggevolezza. Caratteristiche ideali per il settore contract e per gli eventi. Nova Bancone si adatta perfettamente a contesti come locali, hotel, ristoranti, bar ed eventi, grazie anche alla disponibilità in diverse varianti estetiche: la versione luminosa, che aggiunge un tocco scenografico, la versione basic priva di illuminazione e la finitura velluto, che ne trasforma completamente l'aspetto rendendolo più caldo e raffinato. Il modulo lineare può essere completato con accessori professionali, come la cocktail station e lo speed rack in ABS, offrendo così prestazioni elevate anche nei contesti più dinamici e operativi.

Nova Bar stands out for its minimalist design, softened by a convex front that lightens its visual presence and gives it a sober, contemporary elegance. This formal lightness makes it an extremely versatile element, capable of blending harmoniously into any environment. Its strength lies in the foldable sides that support the polyethylene top in the linear module: a design solution that allows the top to be attached directly to the structure, facilitating transport, optimising space and improving manoeuvrability. Ideal features for the contract sector and events. Nova Bancone is perfectly suited to contexts such as clubs, hotels, restaurants, bars and events, thanks also to the availability of different aesthetic variants: the illuminated version, which adds a dramatic touch, the basic version without lighting and the velvet finish, which completely transforms its appearance, making it warmer and more refined. The linear module can be completed with professional accessories, such as the cocktail station and speed rack in ABS, thus offering high performance even in the most dynamic and operational contexts





Nova bancone luminoso  
Nova light counter



Nova bancone con cocktail station  
 Nova counter with cocktail station

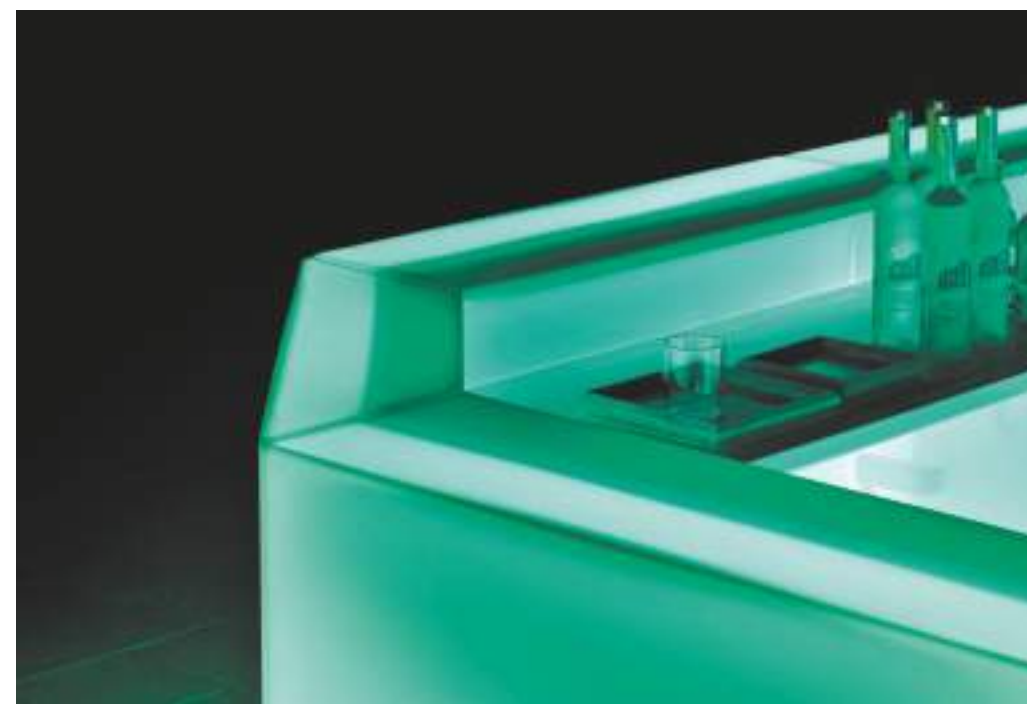

Nova bancone luminoso  
 Nova light counter



Nova bancone luminoso  
Nova light counter

# DUBLIN

Dublin è all'occorrenza postazione bar, modulo cassa e/o reception, le cui forme si ispirano ai banconi dei pub irlandesi in stile Art Decò. Dublin è disponibile in colori monocromatici, nella versione luminosa per le occasioni di tendenza e la versione con finitura velluto, che conferisce maggiore valore estetico eliminando la percezione di plasticità. Realizzato in Poleasy®, un'evoluzione del polietilene, Dublin garantisce elevata resistenza agli agenti atmosferici e una pulizia semplice e rapida, rendendolo ideale per un uso professionale e intensivo. La collezione comprende un modulo lineare e un modulo angolare monoblocco. Il vero punto di forza risiede nei fianchi richiudibili del modulo lineare, che sostengono il piano in polietilene e consentono di agganciarlo direttamente alla struttura. Questa soluzione progettuale facilita il trasporto, ottimizza lo spazio e migliora la maneggevolezza, caratteristiche fondamentali per il settore contract e per gli eventi itineranti. Il modulo lineare può essere completato con accessori professionali, come la cocktail station e lo speed rack in ABS, offrendo così prestazioni elevate anche nei contesti più dinamici e operativi.

Dublin can be used as a bar counter, cash desk and/or reception desk, with shapes inspired by Art Deco-style Irish pub counters. Dublin is available in monochromatic colours, in a luminous version for trendy occasions and in a velvet finish version, which adds aesthetic value by eliminating the perception of plasticity. Made of Poleasy®, an evolution of polyethylene, Dublin guarantees high resistance to atmospheric agents and quick and easy cleaning, making it ideal for professional and intensive use. The collection includes a linear module and a monobloc corner module. The real strength lies in the closable sides of the linear module, which support the polyethylene top and allow it to be attached directly to the structure. This design solution facilitates transport, optimises space and improves manoeuvrability, which are essential features for the contract sector and travelling events. The linear module can be completed with professional accessories, such as the cocktail station and speed rack in ABS, thus offering high performance even in the most dynamic and operational contexts.





Dublin bancone luminoso  
Dublin light counter



Dublin bancone con cocktail station  
Dublin counter with cocktail station





Dublin bancone in finitura velvet  
Dublin counter in velvet finishing

# BARAONDA

L'ispirazione alla base di Baraonda di MY YOUR è un'onda sinuosa che avvolge il bancone, dando vita a una composizione libera e modulare in molteplici varianti. Disponibile sia in versione con o senza luce non oltre alla raffinata finitura velluto, Baraonda è progettato per essere facilmente trasportabile, richiudibile e stoccabile grazie alle ante richiudibili del modulo lineare. Nel tempo, Baraonda è diventato un'icona di stile e funzionalità nel suo segmento di riferimento, grazie alla sua grande personalità e al design elegante che lo rendono un elemento unico e altamente personalizzabile, capace di accendere ogni sfumatura della festa. La funzionalità di Baraonda si amplia ulteriormente con il retrobanco Display, anch'esso illuminabile, ideale per l'esposizione di bottiglie e materiali di utilizzo. Per il modulo lineare sono inoltre disponibili come optional la cocktail station e lo speed rack in ABS, che garantiscono performance elevate anche negli ambienti più dinamici e operativi.

The inspiration behind MY YOUR's Baraonda is a sinuous wave that envelops the counter, creating a free and modular composition in multiple variations. Available in versions with or without lighting, as well as in a refined velvet finish, Baraonda is designed to be easily transportable, foldable and storable thanks to the foldable doors of the linear module. Over time, Baraonda has become an icon of style and functionality in its segment, thanks to its great personality and elegant design, which make it a unique and highly customisable element, capable of lighting up every nuance of the party. Baraonda's functionality is further enhanced by the Display back counter, which can also be illuminated, ideal for displaying bottles and other items. The linear module also offers optional ABS cocktail stations and speed racks, which guarantee high performance even in the most dynamic and operational environments.





Baraonda bancone luminoso e Display contenitore retrobanco luminoso  
Baraonda light counter and Display light storage back-counter

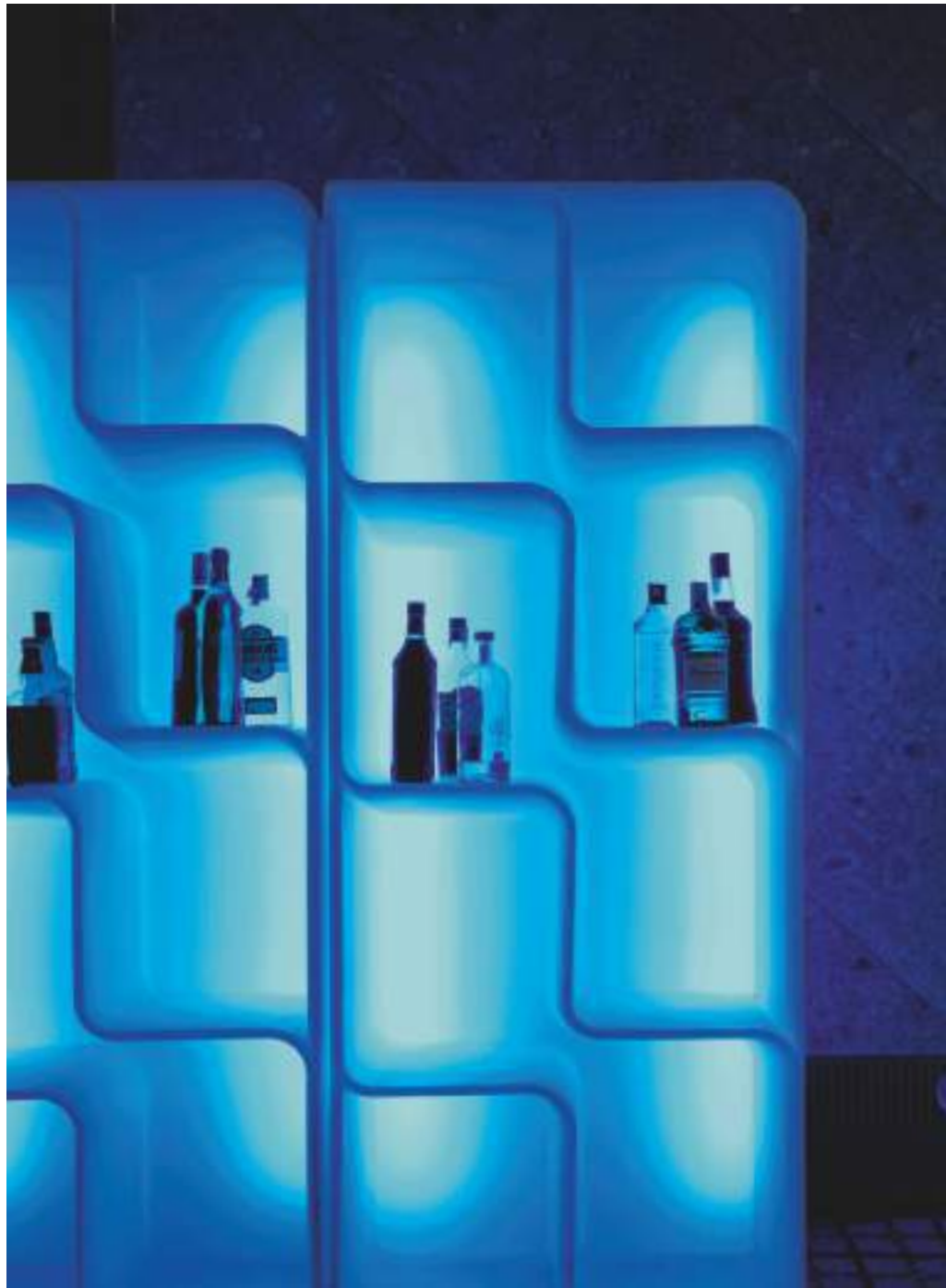

Baraonda Display contenitore retrobanco luminoso  
Baraonda Display light storage back-counter

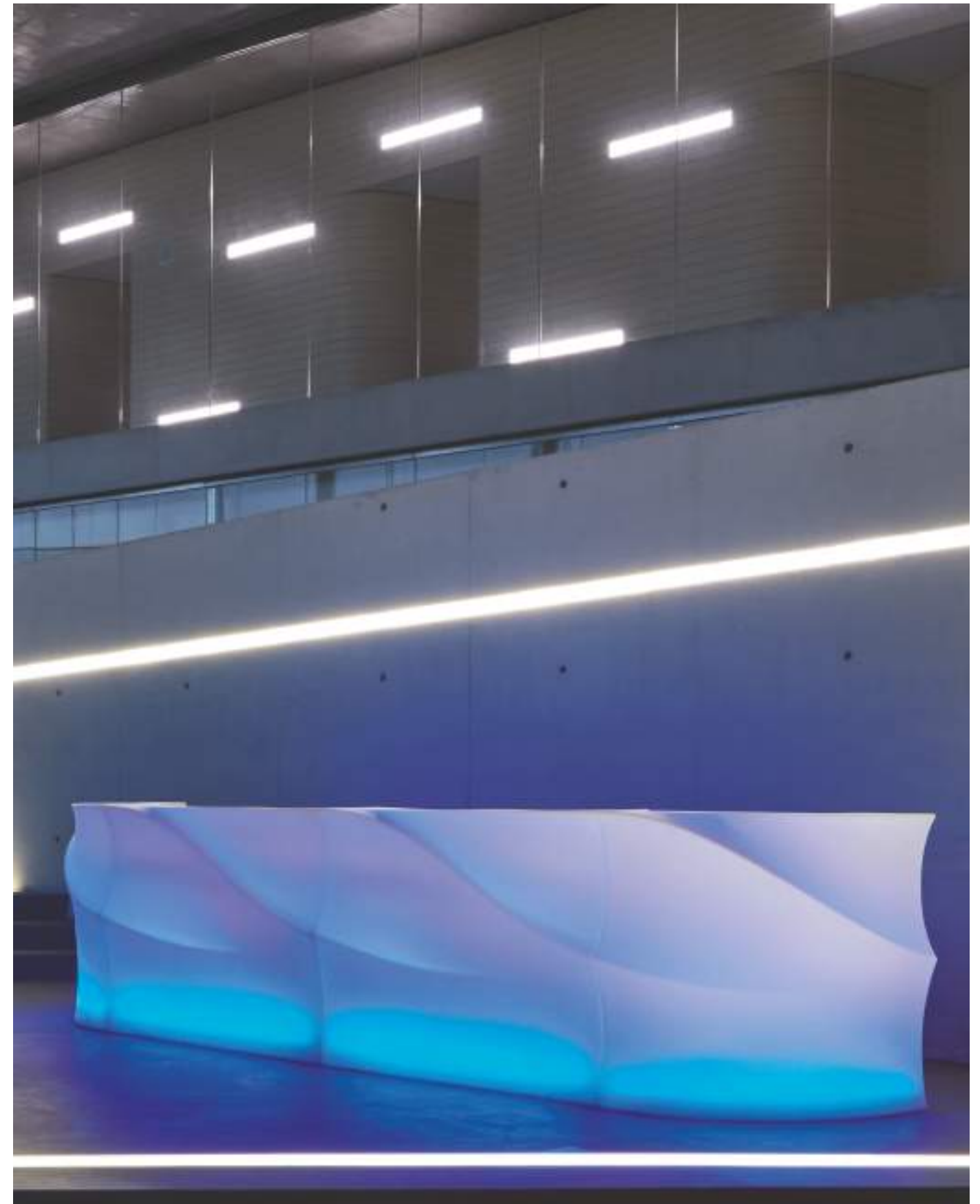

Baraonda bancone luminoso  
Baraonda light counter



Baraonda bancone e cocktail station  
Baraonda counter and cocktail station

# SAMURAI

Samurai è una collezione di sedute modulari outdoor dalle linee pulite ed essenziali ed è caratterizzata da una seduta ampia e bassa che ne implementa la leggerezza visiva. I braccioli e gli schienali, dalle forme contenute e aperte leggermente, accolgono i cuscini di seduta, aumentandone il comfort mentre i piedini sollevano e sostengono la struttura. Samurai si presenta in due versioni: Samurai Baseline con imbottitura in poliuretano e tessuto impermeabile Sunbrella® e Samurai Plusline, sempre con imbottitura in poliuretano ma con membrana protettiva e traspirante e tessuto Sunbrella®. La collezione è disponibile anche nella versione IN THE WATER, posizionabile nella parte spiaggia/relax della piscina.

Samurai is a collection of modular outdoor seating with clean, essential lines, characterised by a wide, low seat that enhances its visual lightness. The armrests and backrests, with their compact, slightly open shapes, accommodate the seat cushions, increasing comfort, while the feet lift and support the structure. Samurai comes in two versions: Samurai Baseline with polyurethane padding and waterproof Sunbrella® fabric, and Samurai Plusline, also with polyurethane padding but with a protective, breathable membrane and Sunbrella® fabric. The collection is also available in the IN THE WATER version, which can be placed in the beach/relaxation area of the pool.





Samurai divano 3 posti, Samurai poltrona, Samurai tavolino, Pandora vasi S e M, Aladdin tappeto tondo - catalogo Soft+Alu  
Samurai 3 seats sofa, Samurai armchair, Samurai coffee table, Pandora pots S and M, Aladdin round rug - Soft+Alu catalog



Samurai poltrona, Samurai tavolino  
Samurai armchair, Samurai coffee table



Samurai divano 4 posti, Samurai poltrona, Samurai tavolino, Aladdin tappeto - catalogo Soft+Alu  
Samurai 4 seats sofa, Samurai armchair, Samurai coffee table, Aladdin rug - Soft+Alu catalog

# CHICO

Chico è un sistema modulare di sedute outdoor ideato da More Design per MY YOUR che si decanta in modulo centrale, moduli laterali e poltrona. Interamente in Poleasy®, il suo decoro distintivo ricorda la trapuntatura del capitonné e le sue forme slanciate gli consentono di arredare spazi anche contenuti. Pensato per ambienti outdoor Chico strizza l'occholino all'interior design nella nuova finitura Velvet, che lo avvolge morbidamente in una veste alto borghese. Disponibile con cuscino di seduta, è testato, in ogni finitura, per resistere agli agenti atmosferici nel tempo ed è facilmente lavabile.

Chico is a modular outdoor seating system designed by More Design for MY YOUR, consisting of a central module, side modules and an armchair. Made entirely of Poleasy®, its distinctive decoration is reminiscent of capitonné quilting, and its slender shapes allow it to furnish even small spaces. Designed for outdoor environments, Chico gives a nod to interior design in the new Velvet finish, which softly envelops it in an upper-class look. Available with a seat cushion, it is tested in every finish to withstand the elements over time and is easily washable.





Chico divano 3 posti, Chico divano 2 posti, Chico poltrona, 2054 tavolino, tappeto Aladdin - catalogo Soft+Alu  
Chico 3 seats sofa, Chico 2 seats sofa, Chico armchair, 2054 coffee table, Aladdin rug - Soft+Alu catalog



Chico poltrona,  
Chico armchair



Chico poltrona,  
Chico armchair



Chico divano 3 posti, Chico poltrona, 2054 tavolino, tappeto Aladdin - catalogo Soft+Alu  
Chico 3 seats sofa, Chico armchair, 2054 coffee table, Aladdin rug- Soft+Alu catalog

# NOVA SET

Pensata per l'outdoor la collezione Nova è capace di sintetizzare sapientemente volumi sinuosi ed eleganza minimale, in un perfetto comfort funzionale. Il design curvo è identificativo e richiama spazi all'aria aperta in cui farsi avvolgere dalla sue linee. La collezione è composta da divani in due altezze differenti, poltrona e tavolino 2054. Tutti i moduli sono in Poleasy® e le sedute abbinabili al loro cuscino accessorio; tutti gli elementi sono disponibili anche con la finitura velvet. Grazie al suo design minimal ed elegante, garantisce un comfort avvolgente e una versatilità verso ogni tipo di outdoor in cui essere inserita. Testata per l'esterno, è di facile pulizia e manutenzione.

Designed for outdoor use, the Nova collection skilfully combines sinuous volumes and minimalist elegance with perfect functional comfort. The curved design is distinctive and evokes open-air spaces where you can be enveloped by its lines. The collection consists of sofas in two different heights, an armchair and a 2054 coffee table. All modules are made of Poleasy® and the seats can be combined with their accessory cushions; all elements are also available with the velvet finish. Thanks to its minimalist and elegant design, it guarantees enveloping comfort and versatility for any type of outdoor setting. Tested for outdoor use, it is easy to clean and maintain.





Nova divano 2 posti con cuscini TE, 2054 tavolino, Agata Wood lampada da terra, Aladdin tappeto - catalogo Soft+Alu  
Nova 2 seats sofa with TE cushions, 2054 coffee table, Agata Wood standing lamp, Aladdin rug - Soft+Alu catalog



Nova poltrone, 2054 tavolino  
 Nova armchairs, 2054 coffee table.



Nova divano 2 posti con cuscini TE, Nova poltrona, 2054 tavolino  
 Nova 2 seats sofa with TE cushions, Nova armchair, 2054 coffee table

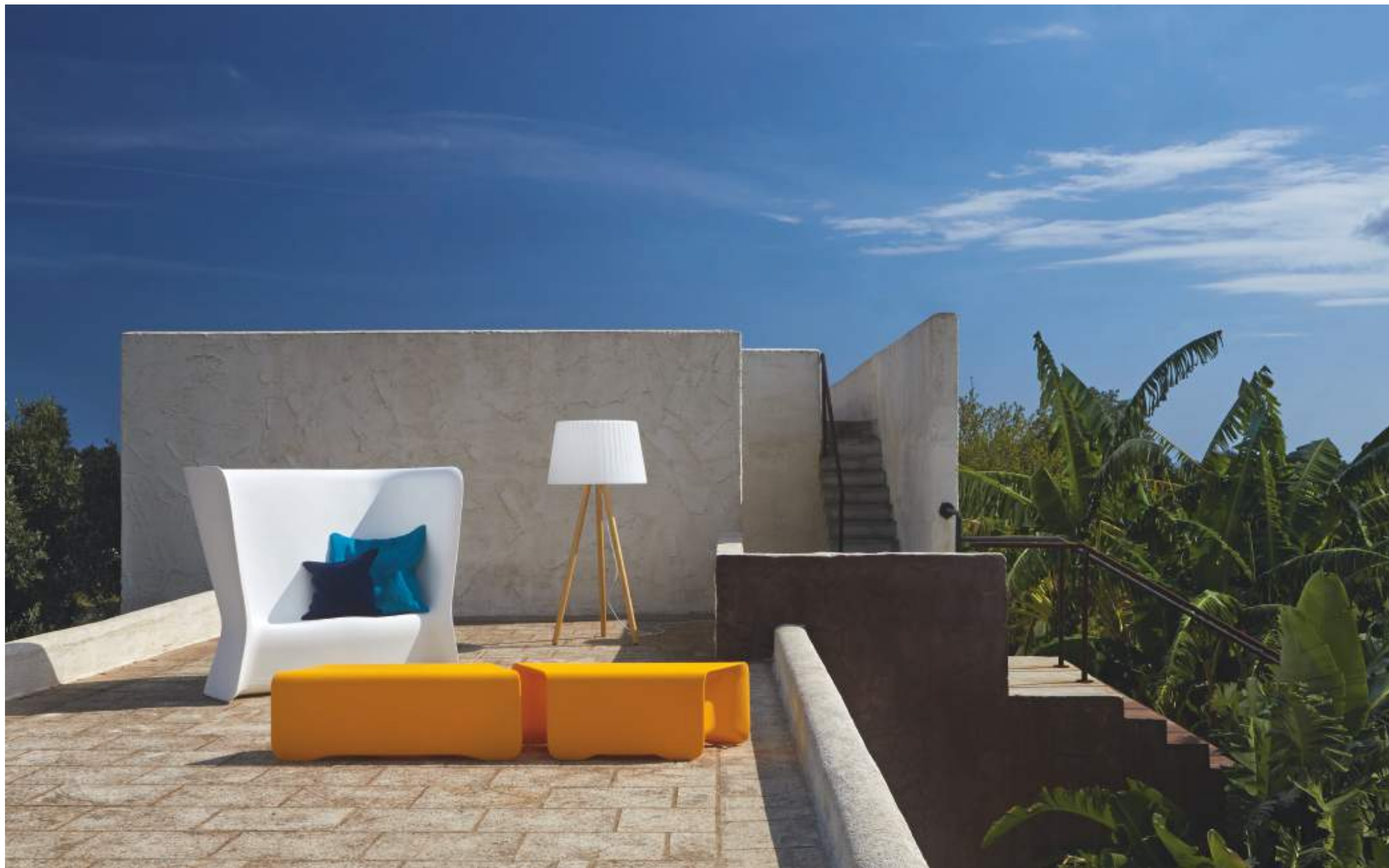

Nova divano XL, panca Nova e Agata Wood  
NXL Nova sofa, Nova bench and Agata Wood

# LILY

Lily la collezione disegnata da More Design per MY YOUR composta da divano, poltrona, sedia e tavolino con o senza spumantiera. Forte e poetica, il cuore del progetto Lily è il design organico volto a simulare il petalo di un fiore: una sfida per le tecniche di ingegnerizzazione. Una proposta outdoor polivalente, elegante e confortevole del concetto living e dining. È disponibile la versione illuminabile per il tavolino e il cuscino di seduta a complemento di divani, poltrone e sedie per rendere l'utilizzo ancora più rilassante e avvolgente, ovunque Voi siate. Il tavolino è disponibile anche nella versione IN THE WATER posizionabile nella parte spiaggetta/relax della piscina.

Lily, the collection designed by More Design for MY YOUR, consists of a sofa, armchair, chair and coffee table with or without a champagne bucket. Strong and poetic, the heart of the Lily project is its organic design, which aims to simulate the petal of a flower: a challenge for engineering techniques. A versatile, elegant and comfortable outdoor proposal for the living and dining concept. An illuminated version is available for the coffee table and seat cushions to complement sofas, armchairs and chairs, making them even more relaxing and enveloping, wherever you are. The coffee table is also available in the IN THE WATER version, which can be placed in the beach/relaxation area of the swimming pool.





Lily poltrone  
Lily armchairs



Lily tavolino con ice-box, Lily divano 2 posti con cuscino TE, Lily poltrone  
Lily coffee table with ice-box, Lily 2 seats sofa with TE cushion, Lily armchairs

# MODI`

Modi è un sistema modulare di sedute e complementi outdoor disegnata da More Design che si trasforma in varie configurazioni e adattabile a ogni spazio. Partendo progettualmente da un'unica base rettangolare in Poleasy®, la modularità è composta da seduta, bracciolo/schienale, angolo tutti in ecopelle con schiumato interno in poliuretano e piano in vetro. In questo modo possiamo ottenere dalla poltrona al divano dritto o sezionale al tavolino semplicemente combinando i vari elementi a disposizione, creando un decoro che richiama le trapuntature classiche quiltate e arredando con versatilità qualsiasi spazio esterno.

Modi is a modular system of outdoor seating and accessories designed by More Design that can be transformed into various configurations and adapted to any space. Starting from a single rectangular base in Poleasy®, the modularity consists of a seat, armrest/backrest and corner, all in eco-leather with polyurethane foam padding and a glass top. In this way, we can create anything from an armchair to a straight or sectional sofa to a coffee table simply by combining the various elements available, creating a design that recalls classic quilted upholstery and furnishing any outdoor space with versatility.

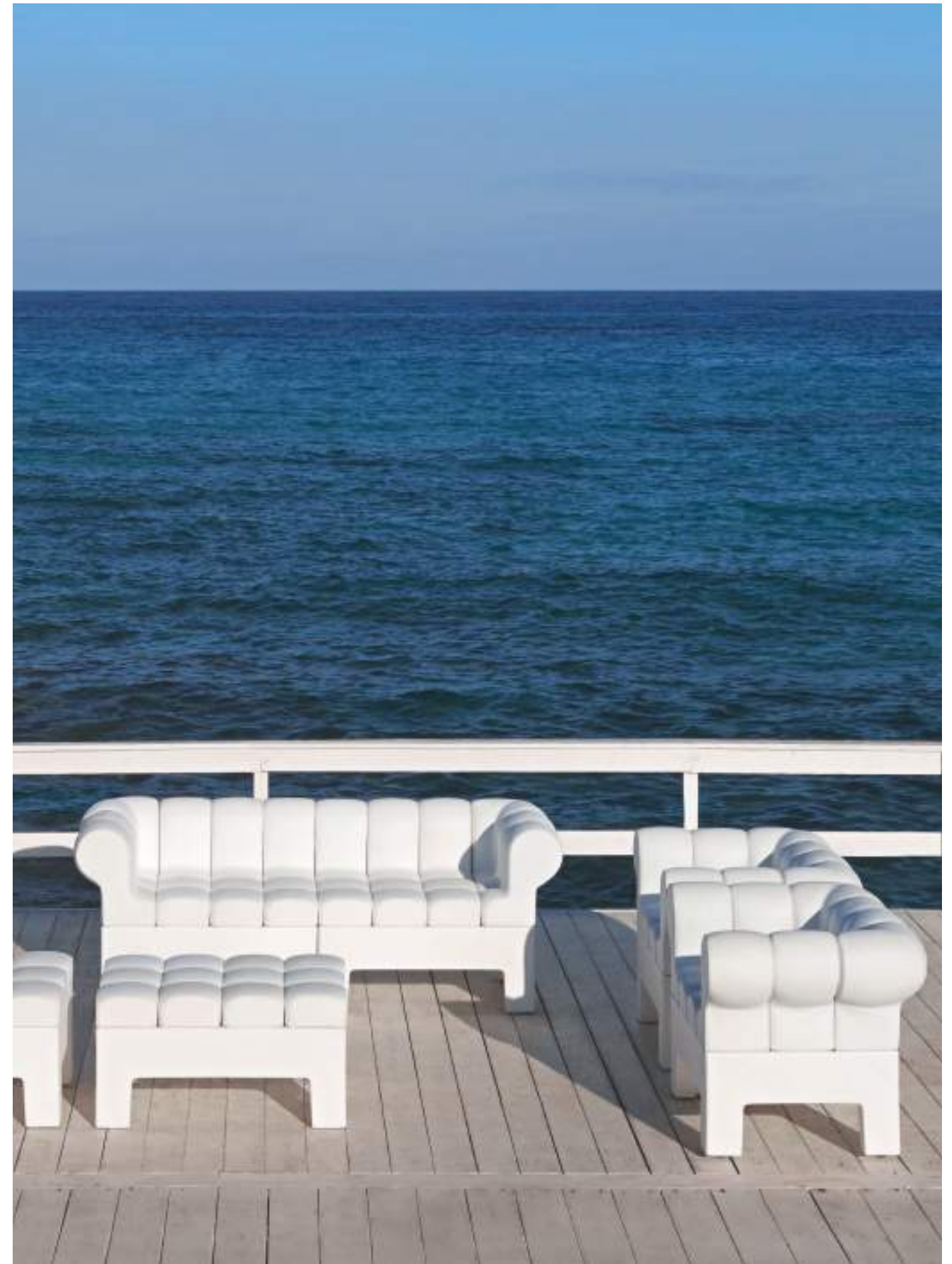



# IRIS

La caratteristica distintiva della collezione Iris è senza dubbio il suo design composto da linee curve e morbide. Queste forme sinuose conferiscono agli elementi della collezione un aspetto accogliente, che li rende perfetti per aggiungere un tocco di eleganza e comfort nelle diverse location. La collezione in Poleasy® è composta da poltrona, coffee table, sgabello e tavolo. La poltrona e il tavolino sono la combinazione perfetta per creare un ambiente accogliente, mentre lo sgabello con il tavolo sono ideali per le zone bar e conviviali. Per la poltrona ed il tavolino sono disponibili due diverse finiture: goffrato stampato e velvet entrambe in diversi colori. La combinazione di design accattivante e materiali di alta qualità la rende una scelta ideale per coloro che cercano un arredamento che unisca bellezza, funzionalità e l'etichetta "Made in Italy". Tutti gli elementi della collezione sono inoltre disponibili anche nella versione IN THE WATER posizionabile nella parte spiaggia/relax della piscina.

The distinctive feature of the Iris collection is undoubtedly its design, composed of soft, curved lines. These sinuous shapes give the elements of the collection a welcoming appearance, making them perfect for adding a touch of elegance and comfort to a variety of locations. The Poleasy® collection consists of an armchair, coffee table, stool and table. The armchair and coffee table are the perfect combination for creating a welcoming environment, while the stool and table are ideal for bar and social areas. Two different finishes are available for the armchair and coffee table: embossed and velvet, both in a range of colours. The combination of attractive design and high-quality materials makes it an ideal choice for those looking for furniture that combines beauty, functionality and the "Made in Italy" label. All items in the collection are also available in the IN THE WATER version, which can be placed in the beach/relaxation area of the pool.





Iris poltrone, e tavolini  
Iris armchairs, and coffee tables



Iris poltrone, e tavolino  
Iris armchairs, and coffee table

# COMMUNITY SET

Le suggestioni di un unico corpo scultoreo che si apre divenendo funzionale e definito. Questo il pensiero dietro a Community set ideato da More Design. Un incastro perfetto fra le sedie Rhonda e il tavolo Teddy consentono a questa collezione, interamente in Poleasy®, di essere versatile e adatta anche ad ambienti contenuti. Le linee curve e avvolgenti del design coniugano estetica e sicurezza. Ideale per il settore contract, risponde a qualsiasi esigenza di spazio poiché si adatta a tutti gli ambienti. Disponibile sia in finitura gofrata stampata, sia in versione luminosa con sorgente RGBW e batteria a induzione (per il tavolo Teddy) è testato per gli agenti atmosferici ed è di facile manutenzione e pulizia.

The evocative power of a single sculptural form that opens up to become functional and defined. This is the idea behind the Community set designed by More Design. The perfect fit between the Rhonda chairs and the Teddy table makes this collection, made entirely of Poleasy®, versatile and suitable even for small spaces. The curved, enveloping lines of the design combine aesthetics and safety. Ideal for the contract sector, it meets any space requirement as it adapts to all environments. Available in both embossed printed finish and luminous version with RGBW light source and induction battery (for the Teddy table), it is weather-tested and easy to maintain and clean.





Community Set: poltroncine da pranzo Rhonda e tavolo Teddy  
Community Set: Rhonda dining armchairs and Teddy table

# MR LEM

Ispirato a una navicella spaziale e al primo sbarco sulla luna, Mr Lem è uno sgabello dal design iconico e minimale. Le sue linee decise e la forma simmetrica permettono un pratico incastro: due pouf possono essere sistemati nell'ingombro di uno solo, ottimizzando spazio e trasporto. Realizzato in Poleasy®, materiale innovativo e resistente, è perfetto per ambienti indoor e outdoor. Impilabile, leggero, facile da pulire e testato per l'uso esterno, aggiunge un tocco glamour e brioso a ogni spazio.

Inspired by a spacecraft and the first moon landing, Mr Lem is a stool with an iconic and minimal design. Its bold lines and symmetrical shape allow for practical stacking: two poufs can fit within the space of one, optimizing storage and transport.

Made of Poleasy®, an innovative and durable material, it's ideal for both indoor and outdoor settings. Stackable, lightweight, easy to clean, and tested for outdoor use, Mr Lem brings a playful and stylish touch to any space.



# PANDORA

La collezione Pandora è fra le più rappresentative e riconoscibili per i prodotti in materia plastica ed è la natura ad ispirarne le forme, il cui pattern ne enfatizza la personalità. Il progetto di Brogliato Traverso è infatti multisensoriale: da un'iconica forma ellissoide a sezione circolare, si enfatizza il tatto in modo estremamente gradevole attraverso il decoro a righe concentriche e tridimensionali. Realizzato in Poleasy® si compone di pouf in tre modelli, tavolino, vasi in tre dimensioni, lampade da terra in tre altezze, pouf e tavolini galleggianti luminosi. Perfetta e testata per qualsiasi progetto outdoor, è di facile manutenzione e pulizia. Un oggetto semplice, destinato a durare nel tempo.

The Pandora collection is one of the most representative and recognisable collections of plastic products, inspired by nature, whose patterns emphasise its personality. Brogliato Traverso's design is multisensory: from an iconic ellipsoidal shape with a circular section, the sense of touch is emphasised in an extremely pleasing way through the concentric, three-dimensional striped decoration. Made of Poleasy®, it consists of three models of poufs, a coffee table, vases in three sizes, floor lamps in three heights, poufs and floating luminous tables. Perfect and tested for any outdoor project, it is easy to maintain and clean. A simple object, designed to last over time.





Pandora sgabelli S e M, Pandora tavolino  
Pandora S and M stools, Pandora coffee table

# LIBERTY

La vivacità della collezione Liberty disegnata da More Design nasce dal gioco dei vuoti e dei pieni. Gli ampi fori cavi della struttura esaltano, con la loro asimmetria, l'energia della superficie bicolore. La collezione Liberty denota una forte personalità pop attraverso il binomio cromatico dei materiali e un design organico e funzionale che ne evidenzia le caratteristiche. Perfettamente impilabili, sgabelli e tavoli Liberty arredano e liberano lo spazio con un originale tocco di design. Ideali per il settore contract, per eventi, per locali e ristoranti, resistono agli agenti atmosferici nel tempo e sono facili da mantenere. Tutti gli elementi della collezione sono inoltre disponibili anche nella versione IN THE WATER posizionabile nella parte spiaggia/relax della piscina.

The liveliness of the Liberty collection designed by More Design stems from the interplay of empty and full spaces. The large hollow holes in the structure enhance the energy of the two-tone surface with their asymmetry. The Liberty collection has a strong pop personality thanks to the colour combination of the materials and an organic, functional design that highlights its characteristics. Perfectly stackable, Liberty stools and tables furnish and free up space with an original touch of design. Ideal for the contract sector, events, clubs and restaurants, they are weather-resistant and easy to maintain. All items in the collection are also available in the IN THE WATER version, which can be placed in the beach/relaxation area of the pool.





Liberty tavolo XL, Liberty sgabelli L  
Liberty XL table, Liberty L stools

# OXFORD

Oxford è una collezione, disegnata da Brogliato Traverso per MY YOUR, composta da sgabello e tavolo alto H 110 cm con piano in Poleasy®, dalle forme geometriche che dissimulano il materiale plastico ed emulano la forma iconica dello sgabello treppiede in legno. Lo smontaggio delle gambe assicura, inoltre, un contenuto volume di trasporto e stoccaggio. Entrambi i prodotti sono perfetti per il settore contract e hospitality. Testati contro gli agenti atmosferici, si puliscono e si mantengono facilmente.

Oxford is a collection designed by Brogliato Traverso for MY YOUR, consisting of a stool and a 110 cm high table with a Poleasy® top, with geometric shapes that conceal the plastic material and emulate the iconic shape of the wooden tripod stool. The legs can be dismantled, ensuring a compact size for transport and storage. Both products are perfect for the contract and hospitality sectors. Tested against atmospheric agents, they are easy to clean and maintain.



# CLOE

Il suo nome in greco antico significa "fresco" e "giovane". Allo stesso modo MY YOUR interpreta il concetto di lettino da sole con Cloe, disegnato da More Design, attraverso un design sinuoso e organico che forma un'onda maestosa e fresca. Scultorea, elegante, versatile. Cloe è adatta a qualsiasi ambiente esterno, può essere parzialmente immersa in acqua per la collocazione in piscina e in mare. Realizzata in Poleasy®, al 100% riciclabile, di facile pulizia, resiste agli agenti atmosferici e ai raggi UV. disponibili anche nella versione IN THE WATER posizionabile nella parte spiaggetta/relax della piscina.

Its name in ancient Greek means 'fresh' and 'young'. Similarly, MY YOUR interprets the concept of a sun lounger with Cloe, designed by More Design, through a sinuous and organic design that forms a majestic and fresh wave. Sculptural, elegant and versatile, Cloe is suitable for any outdoor environment and can be partially submerged in water for use in swimming pools and the sea. Made of Poleasy®, it is 100% recyclable, easy to clean and resistant to atmospheric agents and UV rays. Also available in the IN THE WATER version, which can be placed in the beach/relaxation area of the swimming pool.

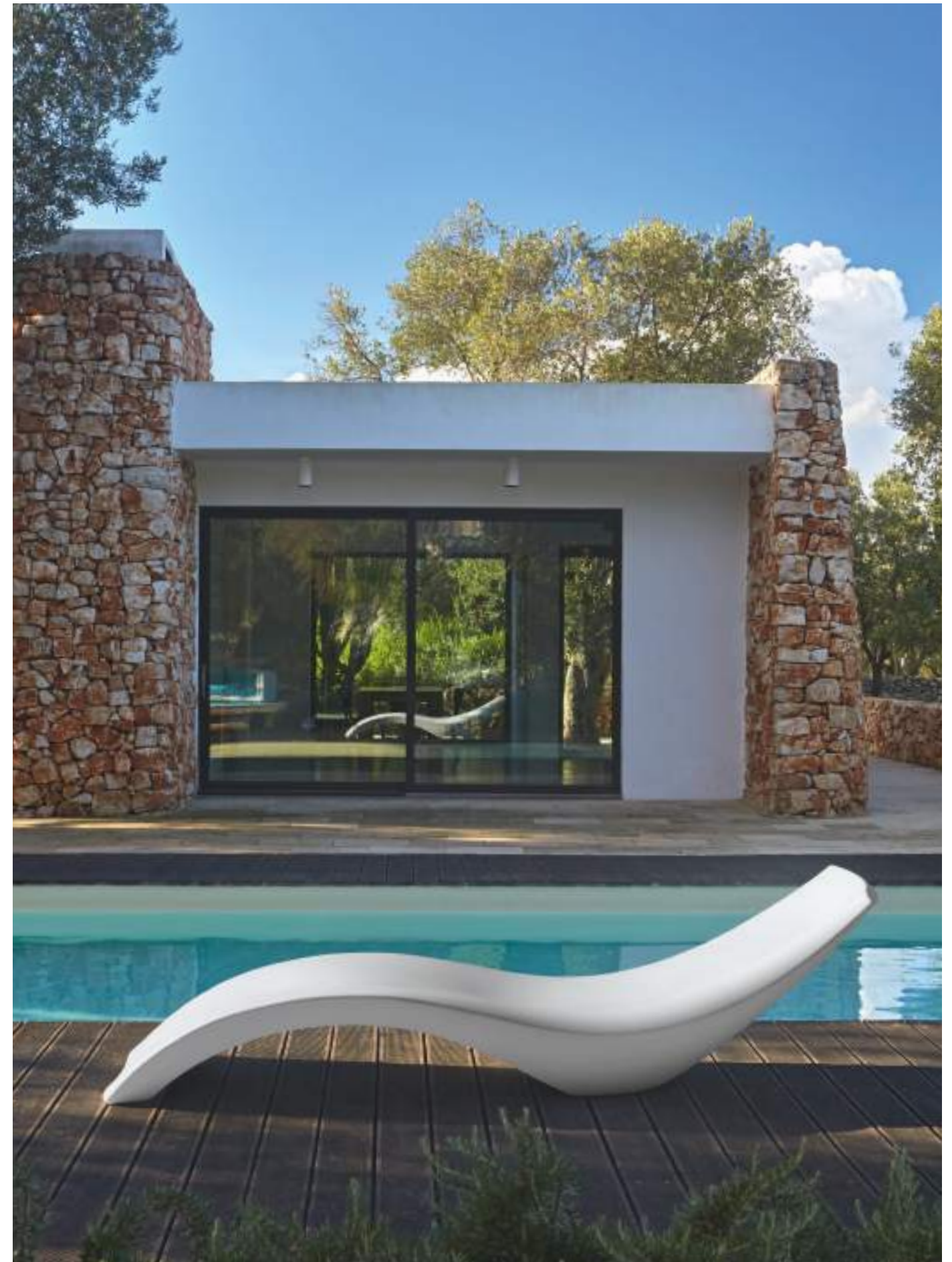



Cloe lettino  
Cloe sunbed





Cloe lettini, Iris tavolini  
Cloe sunbeds, Iris coffee tables

# ZOE

Il lettino Zoe, ideato da More Design per MY YOUR, è la naturale evoluzione di Cloe. Il plus è lo schienale reclinabile in diverse posizioni che consente un comfort superiore. La regolazione avviene tramite pressione del pulsante laterale che aziona il pistone a gas interno. La scocca, interamente riciclabile e realizzata in Poleasy® contiene dispositivi metallici cromati e testati per resistere agli agenti atmosferici. Zoe è, pertanto, un lettino da sole irrinunciabile per arredare piscine, stabilimenti balneari e giardini in cui il relax sia accompagnato da solidità, robustezza e da un design decisamente distintivo.

The Zoe sunbed, designed by More Design for MY YOUR, is the natural evolution of Cloe. The added bonus is the backrest, which can be reclined to different positions for superior comfort. It can be adjusted by pressing the side button, which activates the internal gas piston. The frame, which is entirely recyclable and made of Poleasy®, contains chrome-plated metal components that have been tested to withstand atmospheric agents. Zoe is therefore an essential sun lounger for furnishing swimming pools, beach resorts and gardens where relaxation is accompanied by solidity, sturdiness and a decidedly distinctive design.





Zoe lettino  
Zoe sunbed

# DYNO

Una forte personalizzazione del giardino e del bordo piscina sono gli obiettivi che hanno guidato MY YOUR nel progetto della doccia per esterni Dyno. Disegnata da More Design, dalle forme sinuosamente ergonomiche, è disponibile in bianco nella versione gofrata stampata. La base Paw realizzata in ABS è dotata di profili per trattenere la sabbia ed è rivestita con un film acrilico che rende più efficaci, comode e sicure le operazioni di pulizia. Dyno è stabilizzata per resistere ai raggi UV e agli agenti atmosferici.

Strong personalisation of the garden and poolside area were the objectives that guided MY YOUR in the design of the Dyno outdoor shower. Designed by More Design, with sinuous ergonomic shapes, it is available in white in the embossed moulded version. The Paw base, made of ABS, is equipped with profiles to retain sand and is coated with an acrylic film that makes cleaning more effective, convenient and safe. Dyno is stabilised to resist UV rays and atmospheric agents.

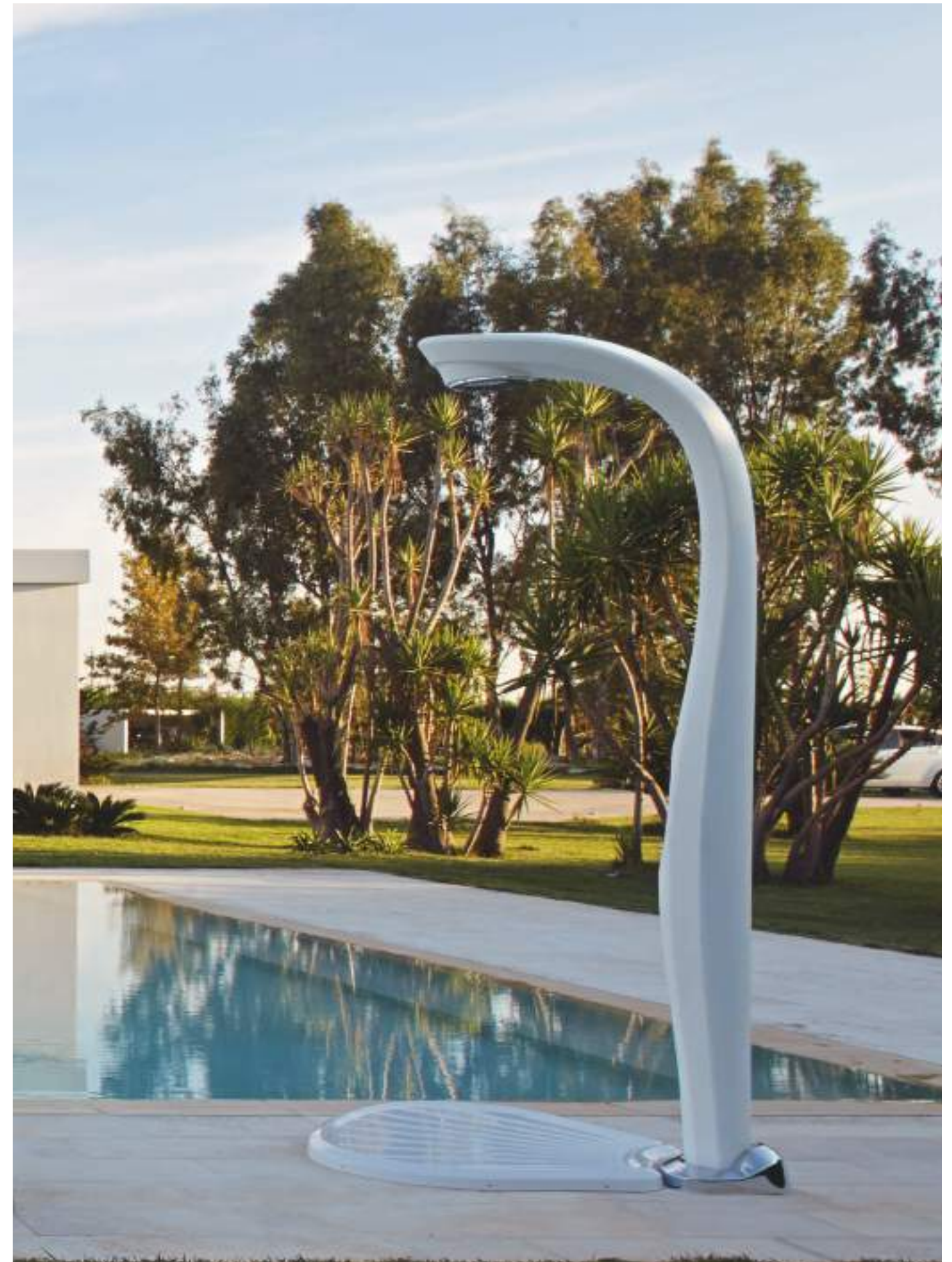

# GEM

Vasi scolpiti come un taglio di pietre preziose. La collezione Gem, di Paolo Cappello per MY YOUR, è proprio questo. Come monoliti raffinati in tre misure, i vasi Gem diventano protagonisti multifunzionali dello spazio poichè possono sia decorarlo, sia perimetrarlo o entrambe le cose. Appaiandosi, infatti, i tre formati possono comporre con differenti possibilità un divisorio o un cinto perimetrale. Disponibili anche in versione luminosa, con finitura velvet e con fioriera ad uso ice-box. Realizzati in Poleasy®, riciclabili al 100%, si puliscono facilmente e resistono nel tempo agli agenti atmosferici.

Vases sculpted like cut precious stones. The Gem collection, by Paolo Cappello for MY YOUR, is just that. Like refined monoliths in three sizes, Gem vases become multifunctional protagonists of the space as they can decorate it, define its perimeter, or both. When paired, the three sizes can be combined in different ways to create a divider or a perimeter border. Also available in a luminous version, with a velvet finish and with a planter for use as an ice box. Made of Poleasy®, 100% recyclable, they are easy to clean and resistant to atmospheric agents over time.





Gem vasi M  
Gem M planter



Gem vasi S e M, Gem fioriera/ ice-box luminosi  
Gem S and M light pots, Gem planter/ ice-box

# PANDORA POTS

Pandora Pots sono i vasi in tre dimensioni che completano la collezione Pandora disegnata da Brogliato Traverso per MY YOUR. Le forme minimali ed elegantemente sinuose, il pattern lineare a rilievo e la morbidezza al tatto conferiscono a questi prodotti la totale versatilità di utilizzo. Lo spazio in cui si trovano, infatti, è decorato e sottolineato in modo sempre borghese. Realizzati in Poleasy®, disponibili nella versione goffrata stampata, direct painting e luminosa, si mantengono facilmente e resistono agli agenti atmosferici. La fioriera come per la collezione Gem può essere usata come ice-box grazie al tappo di evacuazione dell'acqua.

Pandora Pots are vases in three sizes that complete the Pandora collection designed by Brogliato Traverso for MY YOUR. Their minimalist, elegantly sinuous shapes, linear relief pattern and softness to the touch make these products extremely versatile. In fact, the space in which they are placed is decorated and emphasised in a consistently bourgeois style. Made of Poleasy®, available in embossed moulded, direct painting and luminous versions, they are easy to maintain and resistant to atmospheric agents. As with the Gem collection, the planter can be used as an ice box thanks to its water drainage cap.





Pandora vasi S e M  
Pandori S and M planter



Pandora Fioriera/ Ice-box  
Pandora planter/ Ice-box

# SKIN

Skin è una serie di vasi dalla forma elegantemente neoclassica disegnata da Isabella Lovero ed Enrico Bosa. Il design si evidenzia attraverso la texture tridimensionale che ne enfatizza lo stile e la morbidezza al tatto. Con funzione decorativa, sono utilizzabili singolarmente o in composizione nelle due dimensioni disponibili. Luminosi, ossidati e nelle nuances GS, decorano ogni spazio in modo ricco, distintivo e borghese.

Skin is a series of vases with an elegant neoclassical shape designed by Isabella Lovero and Enrico Bosa. The design stands out thanks to its three-dimensional texture, which emphasises its style and softness to the touch. With a decorative function, they can be used individually or in compositions in the two sizes available. Lighted, oxidised and in GS shades, they decorate any space in a rich, distinctive and bourgeois style.





Skin vasi S e L  
Skin S and L pots



Skin vasi S e L luminosi  
Skin S and L light pots

# TAO

Tao è una linea di vasi che sfida la geometria, ispirandosi ai concetti ritmici dello yin e dello yang. Rosaria Copeta disegna per MY YOUR tre forme curve, in grado di incastrarsi perfettamente fra loro a comporre un unico monolite scultoreo seguendo il design del simbolo orientale. I vasi Tao sono liberamente accostabili fra loro e disponibili nelle finiture Velvet e gofrata stampata. Realizzati in Poleasy®, al 100% riciclabili, sono testati per resistere nel tempo agli agenti atmosferici.

Tao is a line of vases that challenges geometry, inspired by the rhythmic concepts of yin and yang. Rosaria Copeta designs three curved shapes for MY YOUR, which fit together perfectly to form a single sculptural monolith following the design of the oriental symbol. Tao pots can be freely combined with each other and are available in Velvet and embossed finishes. Made of 100% recyclable Poleasy®, they are tested to withstand weathering over time.





Tao vasi S, M e L  
Tao S, M and L pots



Tao vasi S, M e L  
Tao S, M and L pots

# FRAMES

Frames è un sistema modulare di separatori d'ambiente zavorrato disegnato da Brogliato Traverso per MY YOUR. Il modulo singolo può essere posizionato preferibilmente orizzontalmente. La decorazione, di derivazione razionalista, gioca sul concetto di vuoti e pieni prospettici. Come piccole fenditure formano scorci geometrici e volumetrici in cui guardare affinché si crei e si amplii un rapporto visivo fra le aree delimitate. Realizzato in Poleasy®, minimale e facilmente trasportabile, è testato per gli agenti atmosferici ed alle incurie del tempo.

Frames is a modular system of weighted room dividers designed by Brogliato Traverso for MY YOUR. The single module can be positioned horizontally. The decoration, derived from rationalism, plays on the concept of perspective voids and solids. Like small slits, they form geometric and volumetric glimpses to look through, creating and expanding a visual relationship between the delimited areas. Made of Poleasy®, minimalist and easily transportable, it is tested for weather resistance and the ravages of time.





Frames divisorio, 2054 divano 3 posti, 2054 poltrona, Pandora tavolino  
Frames divider, 2054 3 seats sofa, 2054 armchair, Pandora coffee table

# BA\_GIGIO

Ba\_Gigio è separatore, cinta perimetrale ed elemento decorativo scultoreo disegnato da Simone Micheli per MY YOUR. L'architetto interpreta il progetto come "un elemento componibile senza limiti a rappresentazione tridimensionale del simbolo dell'infinito, nato dalla rivoluzione dello stesso intorno al proprio asse e come macro immagine spaziale di un legame atomico bipolare". Ba\_Gigio è un elemento che plasma lo spazio e lo suddivide con una forte caratterizzazione, diventandone il protagonista. In diverse componibilità e altezze, è disponibile nella versione full-white goffrata stampata.

Ba\_Gigio is a divider, perimeter fence and sculptural decorative element designed by Simone Micheli for MY YOUR. The architect interprets the project as 'a modular element without limits, a three-dimensional representation of the symbol of infinity, born from its revolution around its own axis and as a macro spatial image of a bipolar atomic bond'. Ba\_Gigio is an element that shapes and divides space with a strong characterisation, becoming its protagonist. Available in different configurations and heights, it comes in a full-white embossed moulded version.





Ba\_Gigio divisorio, Cloe lettino  
Ba\_Gigio divider, Cloe sunbed

# FLAMINGO

Lidi, piscine, discoteche, ristoranti, hotel e tutti gli spazi legati alla collettività necessitano di creare percorsi per gestire i flussi e garantire accessibilità e distanze di sicurezza. MY YOUR ha chiesto a More Design un prodotto gradevole, fruibile ed efficace per questa necessità. Flamingo è un sistema divisorio in multipli che permette di perimetrare gli spazi creando percorsi agili e di dividere gli stessi in modo personalizzato. Alla base una zavorra che evita il fissaggio a terra e ne permette facilmente il posizionamento. Flamingo è interamente realizzato in Poleasy® e dotato di supporti per segnaletica, dispenser e posacenere.

Beaches, swimming pools, nightclubs, restaurants, hotels and all public spaces need to create pathways to manage flows and ensure accessibility and safe distances. MY YOUR asked More Design to create an attractive, usable and effective product for this purpose. Flamingo is a multiple partition system that allows spaces to be delimited, creating flexible pathways and dividing them in a customised way. At the base is a ballast that avoids fixing to the ground and allows for easy positioning. Flamingo is made entirely of Poleasy® and equipped with supports for signage, dispensers and ashtrays.



# TINO

Tino è una sedia indoor-outdoor per bambini che sia anche gioco con una forma riconoscibile. Tino evoca l'infanzia nei suoi valori più puri. Il design di Isabella Lovero ed Enrico Bosa per MY YOUR coniuga tutti questi aspetti creando una sedia-elefantino la cui proboscide, rivolta verso l'alto, diventa schienale. Disponibile anche luminoso, questo prodotto in Poleasy® si distingue per il suo aspetto magicamente unico e beneaugurante. Facile da pulire, resiste ai raggi UV e agli agenti atmosferici.

Tino is an indoor-outdoor chair for children that is also a toy with a recognisable shape. Tino evokes childhood in its purest form. The design by Isabella Lovero and Enrico Bosa for MY YOUR combines all these aspects, creating an elephant chair whose upward-facing trunk becomes the backrest. Also available in a luminous version, this Poleasy® product stands out for its magically unique and auspicious appearance. Easy to clean, it is resistant to UV rays and atmospheric agents.

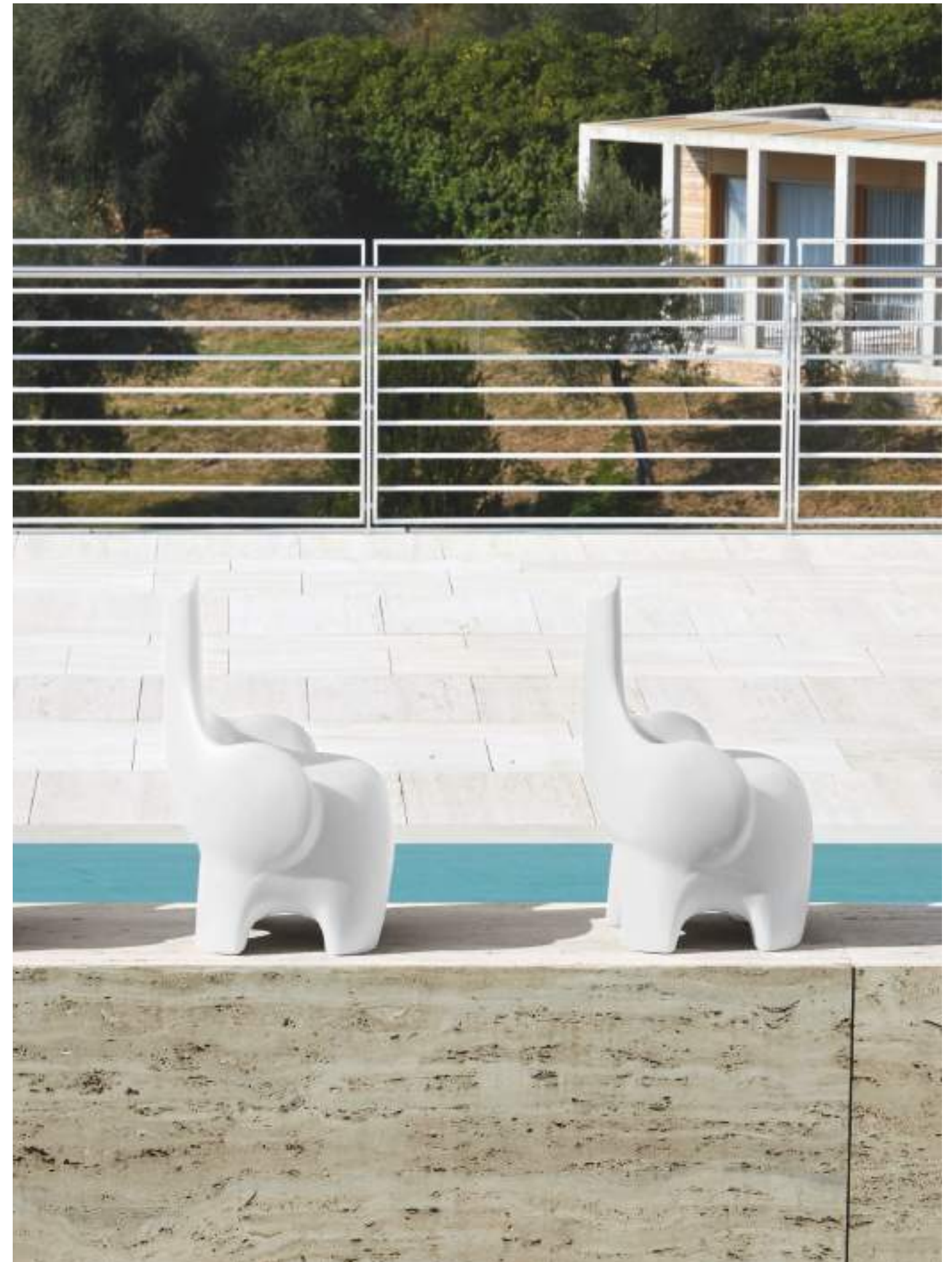

# CRAZY HEAD

Un portacasco da parete con un vano svuota tasche e un gancio appendiabiti. Crazy Head, disegnato da CrousCalogero per MY YOUR, è il complemento d'arredo perfetto per gli amanti della moto. La sua multifunzionalità e il suo design amichevolmente antropomorfo gli conferiscono una totale unicità per il suo settore di riferimento. Realizzato in Poleasy®, disponibile in versione gofrata stampata si può collocare sia in spazi indoor che outdoor che necessitano di una forte personalità. E' facilmente fissabile alle pareti, con tutte le viti nascoste per completarne l'estetica.

A wall-mounted helmet holder with a compartment for emptying pockets and a coat hook. Crazy Head, designed by CrousCalogero for MY YOUR, is the perfect piece of furniture for motorcycle enthusiasts. Its multifunctionality and friendly anthropomorphic design make it totally unique in its sector. Made of Poleasy®, available in an embossed moulded version, it can be placed in both indoor and outdoor spaces that need a strong personality. It is easy to fix to walls, with all screws hidden to complete its aesthetic appeal.



# LIGHT INDEX

## BY CATEGORY



### Sospensioni Pendant lamps

NEFOS 222

### Lampade da tavolo Table lamps

AMPOULE 206  
LIGHT TALES 224

### Lampade da terra Standing lamps

AGATA 200  
AGATA WOOD 204  
AMPOULE 206  
BABYLOVE 220  
HOLLYWOOD 210  
JOY 192  
PANDORA 214  
PENELOPE 196  
PINA 186  
TULIP 212

### Lampade galleggianti Floating lamps

PANDORA 214  
BABYLOVE 220

# PINA

Pina la Pigna Siciliana è una lampada che rappresenta la combinazione tra design e tradizione siciliana, simbolo di salute, buona fortuna e prosperità, spesso utilizzata come ornamento all'ingresso di case, balconi, terrazze e giardini. Oltre ad illuminare, può essere anche complemento d'arredo, aggiungendo un tocco di particolarità agli ambienti. Ispirata all'iconico archetipo della pigna siciliana, questa creazione cattura immediatamente l'attenzione grazie alla presenza scenica e alle sue dimensioni imponenti. La scelta stilistica si riflette nell'uso di materiali di alta qualità che conferiscono al prodotto un aspetto raffinato e duraturo. Realizzata in Poleasy, Pina è una lampada di grandi dimensioni composta da due parti: la pigna, che può essere illuminata, e il basamento. La pigna, la parte superiore, può essere dotata di un kit luce predisposto per 4 lampadine con attacco E27, oppure può essere illuminata a LED RGBW con una batteria ricaricabile a cavo, ideale per eventi. Il basamento invece rimane senza luce ma personalizzabile con carattere grazie alla finitura velvet.

Pina the Sicilian Pine Cone is a lamp that combines design and Sicilian tradition, a symbol of health, good luck and prosperity, often used as an ornament at the entrance to houses, balconies, terraces and gardens. In addition to providing light, it can also be used as a decorative accessory, adding a touch of uniqueness to any room. Inspired by the iconic Sicilian pine cone, this creation immediately captures the attention thanks to its striking appearance and impressive size. The stylistic choice is reflected in the use of high-quality materials that give the product a refined and durable appearance. Made of Poleasy®, Pina is a large lamp consisting of two parts: the pine cone, which can be illuminated, and the base. The pine cone, the upper part, can be equipped with a light kit designed for four E27 bulbs, or it can be illuminated with a LED RGBW rechargeable battery with a cable, ideal for events. The base, on the other hand, remains unlit but can be customised with character thanks to its velvet finish.

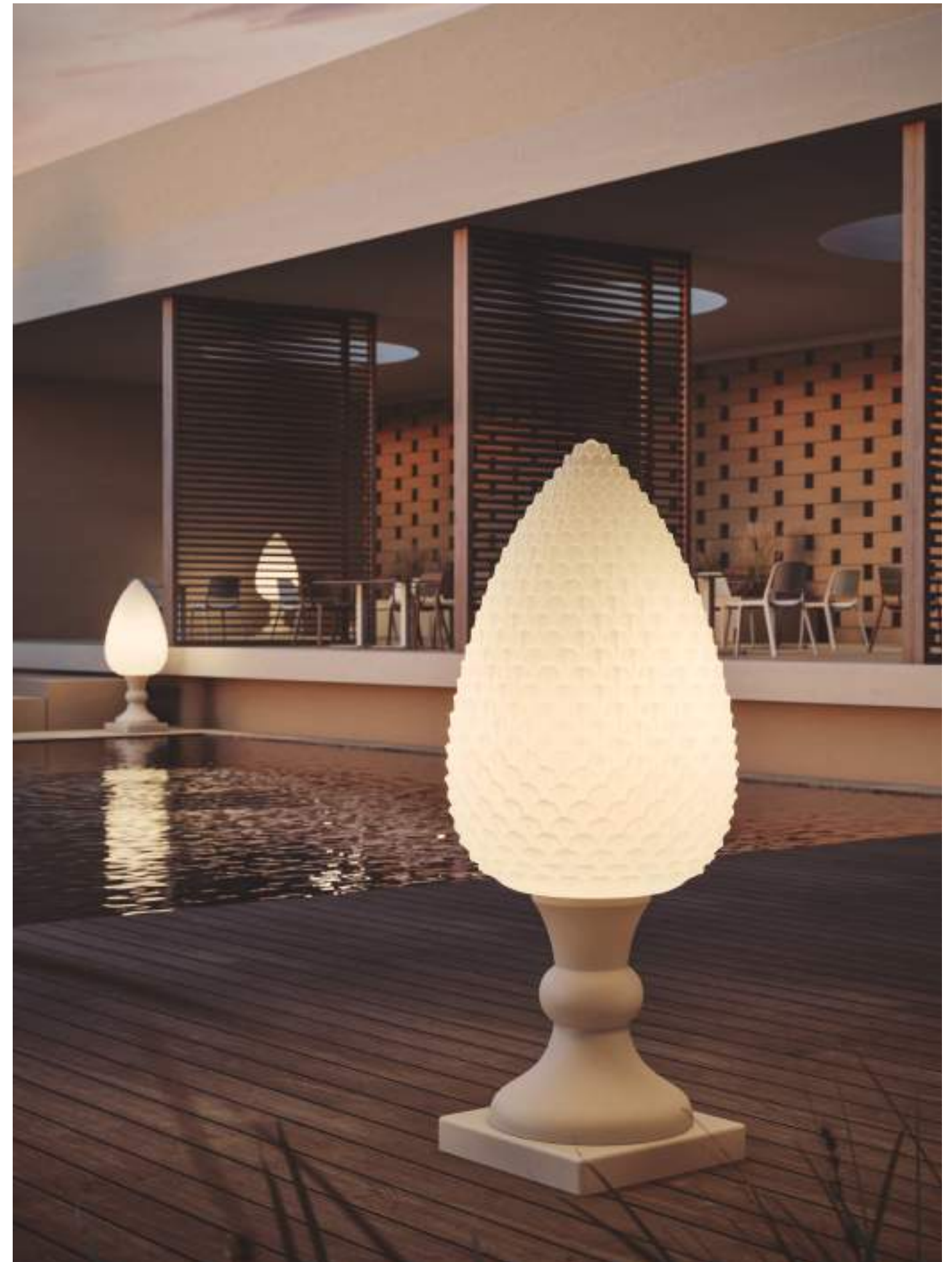



Pina lampade, sedie e sgabelli Emma, tavolo Maja  
Pina lamps, Emma chairs and stools, Maja table



Pina lampade, sedie Tina e tavolo contract Maja  
Pina lamps, Tina chairs and Maja contract table



Pina lampade  
Pina lamps

# JOY

JOY è una lampada da terra in grande formato, disegnata da Lanzavecchia-Wai, che coniuga la base in marmo Trani con i paralumi in Poleasy® attraverso lo stelo in metallo con finitura rame. Joy si ispira dichiaratamente all'atto di infilare le perle in una collana, le cui organiche superfici, realizzate grazie a strumenti di modellazione digitale ed esaltate dal materiale plastico, si fermano sul filo. Questo suggestivo e poetico concept outdoor, unitamente alla linearità del design, consente a Joy di adattarsi a molteplici contesti in cui esserne il gioiello. Disponibile anche nella versione senza base in marmo fissabile al pavimento.

JOY is a large floor lamp designed by Lanzavecchia-Wai, combining a Trani marble base with Poleasy® lampshades via a copper-finish metal stem. Joy is clearly inspired by the act of stringing pearls onto a necklace, whose organic surfaces, created using digital modelling tools and enhanced by the plastic material, rest on the thread. This evocative and poetic outdoor concept, together with the linearity of the design, allows Joy to adapt to multiple contexts in which it can be the jewel in the crown. Also available in a version without a marble base that can be fixed to the floor.





Joy lampade  
Joy lamps

# PENELOPE

Ispirata alla scultura greca classica, è una combinazione di design, tecnologia e caratteristiche funzionali avanguardistiche. Con i suoi 210 cm di altezza, Penelope è fatta per stupire: come lampada illumina qualsiasi spazio con la sua bellezza classica grazie a sistema a LED bianco o RGBW; come scultura, in finitura ossidata, decora con eleganza suggestiva ciò che la circonda. Disegnata da More Design per MY YOUR, Penelope è uno dei prodotti icona di MY YOUR sin dalla sua prima produzione.

Inspired by classical Greek sculpture, it is a combination of design, technology and cutting-edge functional features. Standing 210 cm tall, Penelope is designed to impress: as a lamp, it illuminates any space with its classic beauty thanks to its white or RGBW LED system; as a sculpture, with its oxidised finish, it decorates its surroundings with evocative elegance. Designed by More Design for MY YOUR, Penelope has been one of MY YOUR's iconic products since it was first produced.





Penelope lampada da terra  
Penelope standing lamp

# AGATA

Agata è una lampada piantana a stelo centrale in grande formato, con cavo e lampadine E27, disegnata da More Design per MY YOUR che si ispira dichiaratamente al design classico. La sua contemporaneità si attribuisce al materiale plastico in cui è realizzata e alla progettualità che ha alleggerito le forme smorzandole. La sua duttilità visiva e la sua costruzione tecnologica consentono un perfetto adattamento a qualsiasi ambiente outdoor, tuttavia, la sua eleganza stilistica viene spesso utilizzata anche per la progettazione di interni e l'allestimento di eventi o showroom. Realizzata in Poleasy®, riciclabile al 100%, si pulisce facilmente e resiste nel tempo agli agenti atmosferici e ai raggi UV.

Agata is a large-format floor lamp with a central stem, cable and E27 bulbs, designed by More Design for MY YOUR and clearly inspired by classic design. Its contemporary feel comes from the plastic material it is made of and the design that has lightened and softened its shapes. Its visual flexibility and technological construction allow it to adapt perfectly to any outdoor environment, yet its stylistic elegance is also often used in interior design and event or showroom set-ups. Made of 100% recyclable Poleasy®, it is easy to clean and resistant to weathering and UV rays.





Agata lampada da terra  
Agata standing lamp

# AGATA WOOD

Agata Wood è l'evoluzione di Agata in stile Anni Cinquanta, il cui supporto centrale a treppiede, in legno trattato per esterni, è tipico del design di quell'epoca. Realizzata con la moderna tecnologia rotazionale del diffusore in Poleasy®, Agata Wood si adatta ambivalentemente sia per progetti indoor che outdoor. Di facile manutenzione e pulizia, è testata per i raggi UV e per resistere agli agenti atmosferici.

Agata Wood is the evolution of Agata in 1950s style, whose central tripod support, made of wood treated for outdoor use, is typical of the design of that era. Made with modern rotational technology using Poleasy® diffusers, Agata Wood is suitable for both indoor and outdoor projects. Easy to maintain and clean, it is tested for UV rays and to withstand atmospheric agents.



# AMPOULE

Una goccia di luce. Questo il pensiero ispiratore di Ampoule disegnata da Brogliato Traverso per MY YOUR. Esile e imponente, minimale e decorativa Ampoule è un ossimoro stesso nella sua essenza. Realizzata in Poleasy®, al 100% riciclabile, è disponibile con sorgente luminosa LED RGBW a batteria o con alimentazione a cavo e lampadina con attacco E27. Ampoule conferisce stile a ogni ambiente in cui si trova.

A drop of light. This is the inspiration behind Ampoule, designed by Brogliato Traverso for MY YOUR. Slender and imposing, minimalist and decorative, Ampoule is an oxymoron in its very essence. Made of 100% recyclable Poleasy®, it is available with a battery-powered RGBW LED light source or with a cable power supply and E27 bulb. Ampoule adds style to any environment.





Ampoule XL lampada da terra  
Ampoule XL standing lamp

# HOLLYWOOD

Lampada dal design iconico e riconoscibile, Hollywood caratterizza ogni ambiente grazie al suo suggestivo impatto scenico. L'orientabilità del diffusore illuminato a LED la rende adattabile a multipli contesti: un'area lounge, l'ingresso di un locale o una zona living sia indoor che outdoor. La lampada Hollywood, disegnata da Brogliato Traverso, con il suo mood "fashion-industrial", rievoca un set cinematografico nel quale essere protagonista. Realizzata in Poleasy®, è di facile pulizia ed è testata per resistere nel tempo agli agenti atmosferici.

A lamp with an iconic and recognisable design, Hollywood characterises any environment thanks to its striking visual impact. The adjustable LED light diffuser makes it adaptable to multiple contexts: a lounge area, the entrance to a venue or a living area, both indoors and outdoors. The Hollywood lamp, designed by Brogliato Traverso, with its "fashion-industrial" mood, evokes a film set in which you are the star. Made of Poleasy®, with cable, it is easy to clean and has been tested to withstand weathering over time.



# TULIP

MY YOUR presenta la lampada Tulip, disegnata da More Design nei primi anni di attività e diventa subito simbolo di MY YOUR: un'icona pop senza tempo. Realizzata in Poleasy®, materiale riciclabile al 100%. Tulip è versatile e adatta sia per ambienti indoor che outdoor, illuminando con stile locations prestigiose e sorprendenti in tutto il mondo. Nella nuova versione, l'illuminazione è affidata a una strip LED, capace di valorizzare le forme iconiche di Tulip, rendendo l'esperienza visiva ancora più affascinante e tecnologicamente avanzata. Un successo senza tempo, racchiuso nella delicatezza di un fiore.

MY YOUR presents the Tulip lamp, designed by More Design in the early years of their career, quickly becoming a hallmark of MY YOUR: a timeless pop icon. Crafted from Poleasy®, a fully recyclable material, Tulip is versatile and perfect for both indoor and outdoor settings, bringing style and light to prestigious and unexpected locations worldwide. The new version features an LED strip that beautifully highlights Tulip's iconic silhouette, creating an even more captivating and technologically advanced visual experience. A timeless masterpiece, captured in the delicate form of a flower.



# PANDORA LIGHTS

La collezione Pandora si compone di tre piantane, tre lampade da terra ed una galleggiante. Le piantane a stelo centrale differiscono per paralume che ha lo stesso design delle sedute S, M e L mentre le lampade da terra si arricchiscono del tavolino luminoso anche galleggiante. Disegnate da Brogliato Traverso per MY YOUR, sono arricchite dal pattern distintivo di tutta la collezione. Realizzate in Poleasy®, disponibili con cavo e lampadina E27 nella versione piantana e in luce LED RGBW a batteria nella versione da terra.

The Pandora collection consists of three floor lamps, three table lamps and a floating lamp. The floor lamps with a central stem differ in their lampshades, which have the same design as the S, M and L seats, while the floor lamps are enhanced by the luminous table, which is also floating. Designed by Brogliato Traverso for MY YOUR, they are embellished with the distinctive pattern of the entire collection. Made of Poleasy®, they are available with a cable and E27 bulb in the floor lamp version and with battery-powered RGBW LED lighting in the floor lamp version.

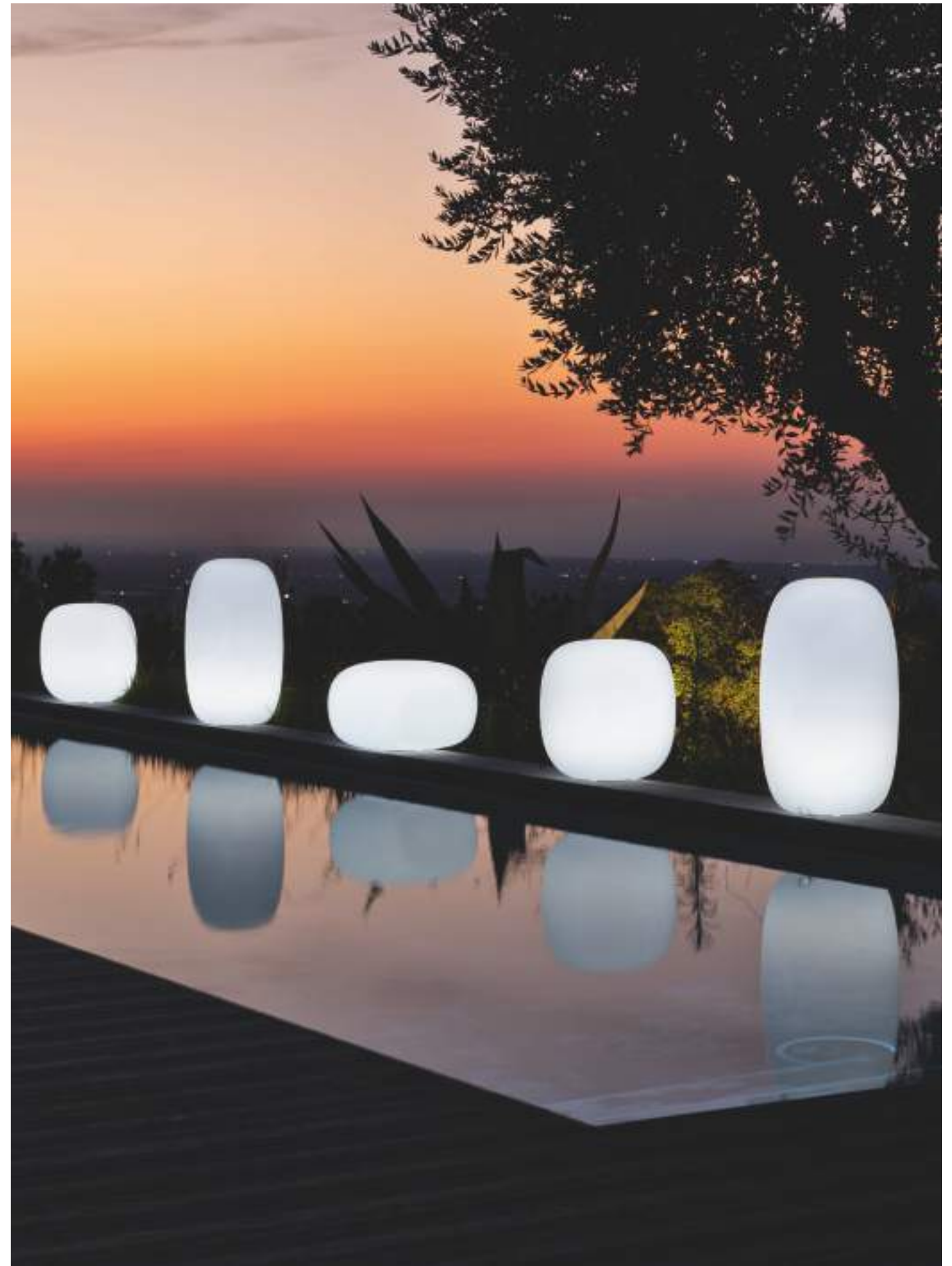



Pandora lampade da terra S, M, L  
Pandora S, M, L floor lamps



Pandora lampade piantane S, M, L  
Pandora S, M, L standing lamps



# BABYLOVE

Disegnata da MY YOUR R&D, lampada galleggiante ornamentale dallo stilizzato design a forma di rosa, Baby Love waterproof è perfetta per piscine situate in ambienti dal target giovanile, per locali e hotel alla moda e per scenografie dal forte impatto visivo. Realizzata con diffusore in Poleasy®, è una risposta poetica e suggestiva alle moderne esigenze di luce decorativa. La fonte luminosa a LED RGBW a batteria si ricarica tramite base ad induzione. Si pulisce facilmente ed è testata per resistere agli agenti atmosferici e ai raggi UV.

Designed by MY YOUR R&D, Baby Love Waterproof is a floating ornamental lamp with a stylized rose-shaped design, perfect for pools in youth-oriented environments, trendy venues and hotels, or visually striking scenographic settings. Made with a Poleasy® diffuser, it offers a poetic and evocative response to modern decorative lighting needs. The RGBW LED light source is battery-powered and recharges via induction base. Easy to clean, it is tested to withstand weather conditions and UV rays.



# NEFOS

Nefos significa "nuvola" in greco. L'Architetto Paolo De Lucchi ha creato per MY YOUR una lampada a sospensione, a luce diffusa, ispirandosi proprio a questo design. Oniricamente suggestiva e quasi felliniana, Nefos illumina tutti gli spazi sia indoor che outdoor che necessitino di un sogno stilistico. Realizzata in Poleasy®, Nefos è dotata di indice di protezione contro gli agenti atmosferici, si pulisce facilmente ed è testata contro le incurie del tempo e i raggi UV. Disponibile in due versioni M a due lampadine con attacco E27 ed L a 3 lampadine con attacco E27.

Nefos means 'cloud' in Greek. Architect Paolo De Lucchi created a diffused light pendant lamp for MY YOUR, inspired by this very design. Dreamlike and almost Fellini-esque, Nefos illuminates all indoor and outdoor spaces that need a stylistic dream. Made of Poleasy®, Nefos is weatherproof, easy to clean and tested against the elements and UV rays. Available in two versions: M with two E27 bulbs and L with three E27 bulbs.



# LIGHT TALES

Dall'idea di Ale Giorgini e dallo sviluppo progettuale di Brogliato Traverso nasce la collezione di lampade da tavolo Light Tales che rappresenta, letteralmente, nel modello Moby "Pinocchio", nel modello Cat "Alice nel paese delle meraviglie", nel modello Tin "Il Mago di Oz", nel modello Rose "La Bella e la Bestia" e nel modello Tri "I tre piccoli porcellini". Moby viene subito esposto in Triennale di Milano per la mostra "Pinocchio" nel 2017 e vince il Good Design Award nello stesso anno. Questa collezione accende la fantasia quando si illumina, ed è perfetta per chiunque voglia sognare e tornare bambino, senza limiti di età. Disponibili sia in versione con cavo da interno e lampadina LED che in versione LED RGBW ricaricabile ad induzione.

The Light Tales table lamp collection was born from an idea by Ale Giorgini and developed by Brogliato Traverso. It literally represents Pinocchio in the Moby model, Alice in Wonderland in the Cat model, The Wizard of Oz in the Tin model, Beauty and the Beast in the Rose model, and The Three Little Pigs in the Tri model. Moby was immediately exhibited at the Triennale di Milano for the 'Pinocchio' exhibition in 2017 and won the Good Design Award in the same year. This collection ignites the imagination when lit and is perfect for anyone who wants to dream and return to childhood, regardless of age. Available in both an indoor cable and LED bulb version and a rechargeable induction RGBW LED version.



### Lanzavecchia+Wai

Francesca Lanzavecchia e Hunn Wai hanno creato il loro Studio di design nel 2009, con sedi a Pavia e a Singapore. I loro progetti comprendono prodotti ed edizioni limitate per aziende dal design iconico e progetti speciali per fondazioni culturali e famose maison. Fra i vari riconoscimenti, il premio EDIDA 2014 di Elle Decor come "Young Designer -Talent of the Year".

Francesca Lanzavecchia and Hunn Wai established their design studio in 2009, with offices in Pavia and Singapore. Their projects include products and limited editions for iconic design brands and special projects for fashion houses and culture foundations. Among their various awards, the 2014 Elle Decor's EDIDA one as "Young Designer Talent of the Year".



JOY

### More Design

E' una società padovana, fondata nel 2007, di industrial design, specializzata in ricerca, innovazione, engineering, industrializzazione e marketing intorno al prodotto, che garantisce il risultato finale secondo le aspettative del cliente. Lavora per aziende riconosciute sia in Italia che all'estero. More Design vince il premio A' Design Award/Gold con la collezione Push di MY YOUR nel 2022.

It is a industrial design company from Padua, founded in 2007, specialized in research, innovation, engineering, industrialization and product marketing, that guarantees the final result according to the customer expectations. It works for recognized companies both in Italy and abroad. More Design won the A' Design Award/Gold with the MY YOUR's Push Collection in 2022.



AGATA - AGATA WOOD  
- CHICO - CLOE -  
COMMUNITY SET - DYN0  
- FLAMINGO - LIBERTY  
- LILY - MODI - MR LEM  
- PENELOPE - PINA -  
SAMURAI - TULIP - ZOE

### Paolo De Lucchi

Paolo De Lucchi si laurea in Architettura al Politecnico di Milano nel 1989. Dopo 8 anni presso lo studio Sottsass Associati e Michele De Lucchi srl, apre a Padova la "delucchiworkshop.com" nel 1998. Come designer collabora con importanti aziende italiane nel settore illuminotecnico e progetta negozi in franchising, showrooms, stands nei settori moda, pelletteria e calzaturiero. Tiene corsi di formazione presso Università e Istituti professionali.

Paolo De Lucchi graduated in architecture at Politecnico di Milano in 1989. After 8 years at Sottsass Associati and Michele De Lucchi srl in Milan, opens in Padua the "delucchiworkshop.com" in 1998. As a designer collaborates with important Italian companies in the lighting sector and ideates franchise stores, showrooms, stands in the fashion, leather goods and footwear sectors. He holds training courses at universities and professional institutes.



NEFOS

### Brogliato Traverso

Brogliato Traverso è uno Studio di product design nato a Vicenza nel 2014. "NO TIME, NO SPACE" è il suo approccio al progetto: un segno dettagliato e leggero nel tempo. Brogliato Traverso lavora per varie aziende e annovera premi alcuni premi internazionali. Con MY YOUR vince il Good Design Award con Pandora e Mobi (2014 , 2017) e il A' Design Award con Everyday e Ampoule nel 2014.

Brogliato Traverso is a product design Studio from Vicenza created in 2014 "NO TIME, NO SPACE" is its approach to the project: a detailed and light mark in time. Brogliato Traverso works for various companies and includes awards some international awards. With MY YOUR it wins the Good Design Award with Pandora and Mobi (2014, 2017) and the 2014 A 'Design Award/Gold with Everyday and Ampoule.



AMPUOLE - FRAMES -  
HOLLYWOOD - NOVA  
- OXFORD - PANDORA -  
PANDORA LIGHTS

### Simone Micheli

Nato nel 1964, si Laurea in Architettura Firenze e fonda il proprio Studio nel 1990. Nel 2003 apre la società di progettazione Simone Micheli Architectural Hero, insieme a Roberta Colla, con numerose sedi nel mondo. La sua attività è multidisciplinare e spazia dai master plan all'architettura e interior, dal product design alla grafica. Annovera progetti architettonici prestigiosi, è curatore di mostre e di eventi, tiene master, conferenze, workshop e lecture presso gli atenei di settore.

Graduated in architecture in Florence, he founded his own Studio in 1990 and the design company Simone Micheli Architectural Hero, together with Roberta Colla, with offices around the world, in 2003. His multidisciplinary activity ranges from master plans to architecture and interior, from product design to graphics. His work includes prestigious architectural projects, curatorship of exhibitions and events and speaking in master's degrees, conferences, workshops and lectures at universities.



BAGIGIO

### Ale Giorgini

Illustratore, fumettista, docente è riconosciuto internazionalmente per il suo tratto distintivo. Multinazionali, testate prestigiose, case di moda e di sportswears iconiche richiedono la sua collaborazione e creatività per distinguere e supportare i propri progetti di comunicazione visiva. Vince il Good Design Award con Mobi (Tales Collection) di MY YOUR nel 2017.

Illustrator, cartoonist, teacher is internationally recognized for its distinctive feature. Multinationals, prestigious magazines, fashion and iconic sportswears companies require his collaboration and creativity to distinguish and support their visual communication projects. He won the Good Design Award with MY YOUR's Mobi (Tales Collection) in 2017.



LIGHT TALES

### Paolo Cappello

Laureato in Disegno Industriale presso il Politecnico di Milano, dopo una collaborazione triennale con Ludovica+Roberto Palomba, nel 2007 apre il proprio studio di design a Verona. Ha vinto numerosi premi internazionali di design tra cui "Young Designer talent" di EDIDA (2011) e Young and Design Award (2011, 2015). I suoi lavori sono stati esposti in molte esposizioni di design in tutto il mondo.

Graduated in Industrial Design at Politecnico di Milano, after a three-years collaboration with Ludovica+Roberto Palomba, in 2007 he setups his own design studio in Verona. He won many international design prizes including EDIDA's "Young Designer Talent" (2011) and Young and Design Award (2011, 2015). His works have been showcased in many design worldwide exhibitions.



GEM

### Isabella Lovero

Industrial Designer dal 2004, lavora per diversi marchi di arredamento. Nel 2007 ha fondato lo studio "en&is" al fianco di Enrico Bosa, creando nuove tipologie di oggetti come il megafono, l'amplificatore passivo iphone, che ha dato vita ad una startup che predilige la ceramica e il legno nel 2011. Dal 2013 è diventata titolare unica di "in&is" specializzata in design per l'elettronica. Dal 2017 insegna product design presso lo IED di Milano.

Industrial Designer since 2004, she works for several furniture brands. In 2007 she founded the "en&is" studio alongside Enrico Bosa, creating new types of objects such as megaphone, iphone passive amplifier, which gave life to a startup favouring ceramics and wood in 2011. From 2013 she became the unique owner of "in&is" specializing in design for electronics. From 2017 she is product design teacher at IED in Milan.



SKIN - TINO

### Marco Maran

Marco Maran, nato a Siena nel 1963, è un designer che unisce ricerca, sintesi e perfezionamento creativo. Ha collaborato con aziende di rilievo nel settore e, grazie all'originalità dei suoi progetti, ha ricevuto numerosi premi e riconoscimenti che testimoniano la qualità e il successo della sua carriera.

Marco Maran, born in Siena in 1963, is a designer who combines research, synthesis, and creative refinement. He has collaborated with leading companies in the field and, thanks to the originality of his projects, has received numerous awards and recognitions that highlight the quality and success of his career.



IRIS

### Enrico Bosa

Enrico Bosa è un designer italiano, laureato al Politecnico di Milano, dove poi ha insegnato. Nei primi anni ha lavorato presso lo studio Stefano Giovannoni a Milano e nel 2007 ha fondato il proprio marchio "en&is" con Isabella Lovero. Tra il 2014 e il 2020 ha lavorato da Marcel Wanders come Project Leader e Direttore Creativo Associato/ Product Design. Vive e lavora ad Amsterdam e collabora con aziende italiane e internazionali.

Enrico Bosa is an Italian designer, graduated in Politecnico di Milano, where he later taught. He worked for his first years career at Stefano Giovannoni Studio in Milan and founded his own brand "en&is" in 2007 with Isabella Lovero. Between 2014 and 2020 he worked at Marcel Wanders as Project Leader and Associate Creative Director/Product Design. He currently lives and works in Amsterdam and collaborates with Italian and iconic international brands.



SKIN - TINO

### CrousCalogero

CrousCalogero è una società di consulenza di product design fondata da Francesc Crous e Alessandro Calogero nel 2009. Oggi rafforzano le loro collaborazioni con marchi internazionali di design, insegnano presso la scuola di design EINA di Barcellona e la Esdesign, Escuela Superior de Diseño de Barcelona. Il loro lavoro è riconosciuto con premi prestigiosi come il Delta d'Argento 2012 e la Selezione Delta 2014 e 2018.

CrousCalogero is a product design consulting company founded by Francesc Crous and Alessandro Calogero in 2009. Today they strengthen their collaborations with international design brands, teach at the EINA design school in Barcelona and the at the Escuela Superior de Diseño de Barcelona. Their work has been recognized with prestigious awards such as the Silver Delta 2012 and the Delta Selection 2014 and 2018.



CRAZY HEAD

### Rosaria Copeta

Nata a Matera nel 1984, consegue la Laurea Magistrale Specialistica in Disegno Industriale e Comunicazione Visiva presso La Sapienza di Roma nel 2009. Menzione speciale al concorso "Young & Design" nel 2010 con il tavolo "LighTable", nel 2013 collabora con lo studio Gumdesign. Nel 2017 torna a Matera e apre il suo studio di industrial design. Dal 2019 è docente di product design presso L'istituto del Design di Matera.

Born in Matera in 1984, she graduated in Industrial Design and Visual Communication at La Sapienza in Rome in 2009. Special mention at the competition "Young & Design" in 2010 with the table "LighTable", in 2013 collaborates with the studio Gumdesign. In 2017 he returns to Matera and opens his own industrial design studio. Since 2019 she has been teaching product design at the Institute of Design in Matera.



TAO



# TECH INDEX

## BY CATEGORY

### Divani e poltrone Sofas and armchairs

CHICO	252
IRIS	256
LILY	254
MODI'	255
NOVA SET	253
SAMURAI	250

### Lettini Sunbeds

CLOE	262
ZOE	263

### Docce Showers

DYNO	264
------	-----

### Vasi Pots

GEM	265
PANDORA POTS	259
SKIN	266
TAO	267

### Sedute Seats

ADA	242
COMMUNITY SET RHONDA	257
EMMA	234
KAREN	235
LIBERTY	260
MR LEM	258
OXFORD	261
PAOLA	236
PANDORA	259
SOFIA	238
TINA	240

### Banconi Counters

BARAONDA	248
DUBLIN	246
NOVA BAR	244
VALE	243

### Separatori Dividers

BA_GIGIO	269
FLAMINGO	270
FRAMES	268

### Tavoli Tables

COMMUNITY SET TEDDY	257
LIBERTY	260
OXFORD	261

### Complementi Accessories

CRAZY HEAD	272
TINO	271

Indice tecnico luci Lights tech index	273
--	-----

# TECH INDEX

BY COLLECTION

ADA	242	LILY	254
BA_GIGIO	269	MODI'	255
BARAONDA	248	MR LEM	258
CHICO	252	NOVA	253
CLOE	262	OXFORD	261
COMMUNITY SET	257	PAOLA	236
CRAZY HEAD	272	PANDORA	259
DUBLIN	246	SAMURAI	250
DYNO	264	SKIN	266
EMMA	234	SOFIA	238
FLAMINGO	270	TAO	267
FRAMES	268	TINA	241
GEM	265	TINO	271
IRIS	256	VALE	243
KAREN	235	ZOE	263
LIBERTY	260		

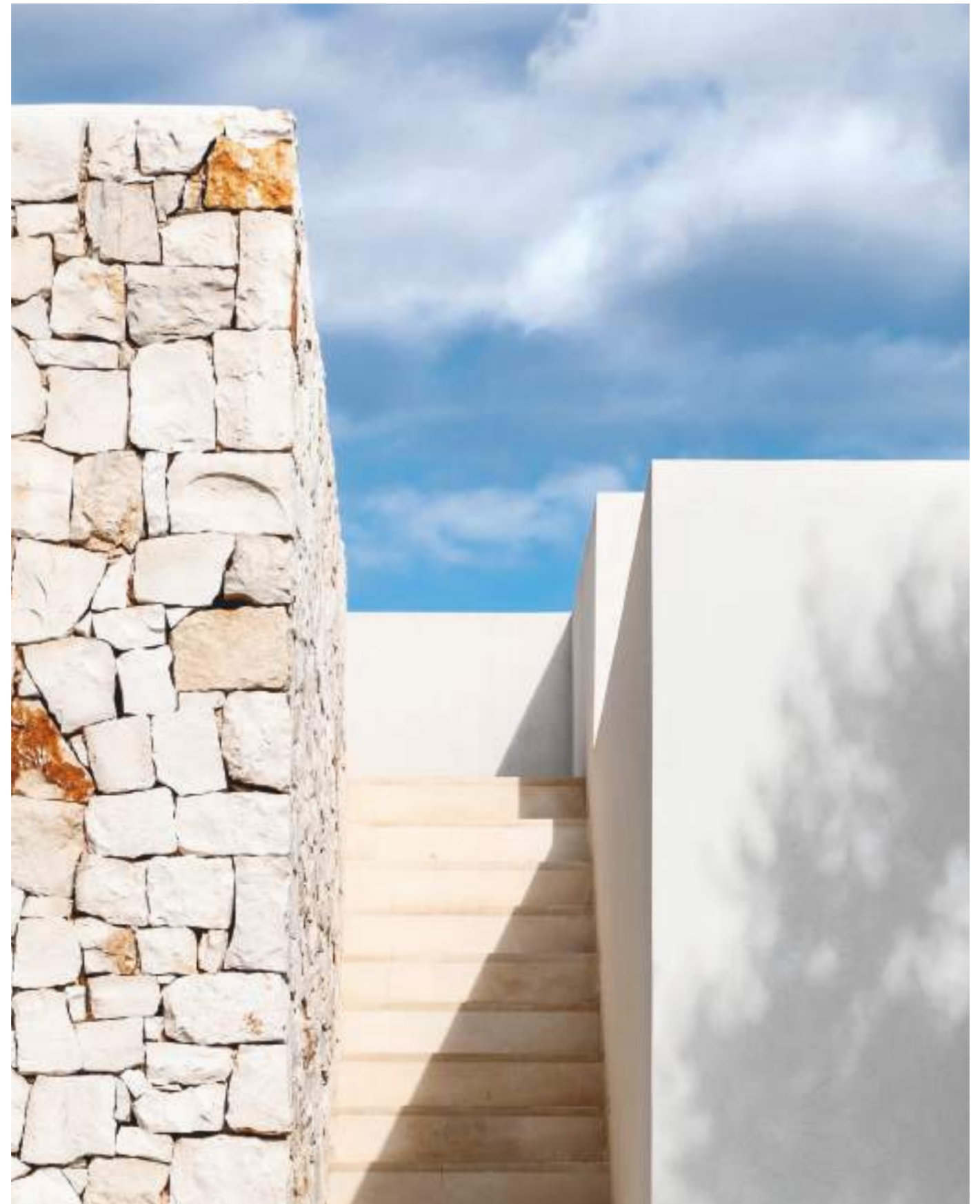

# EMMA

## Sedia Chair

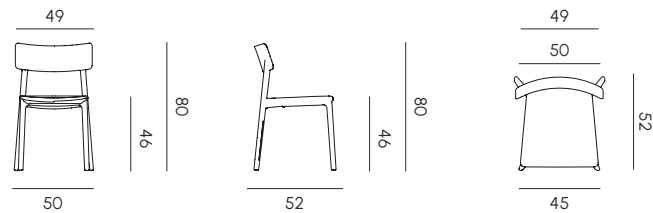

## Sgabello Stool

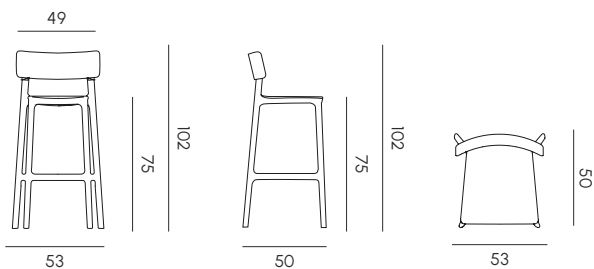

Struttura	Polipropilene + fibre di vetro
Piedini	Polipropilene
Impilaggio consigliato	
Imballo	4 pz

Frame	Polypropylene + glass fiber
Feets	Polypropylene
Recommended stacking method	
Packaging	4 pcs

## Colori e finiture standard Standard colors and finishings

### Finishing - GS



# KAREN

## Sedia Chair

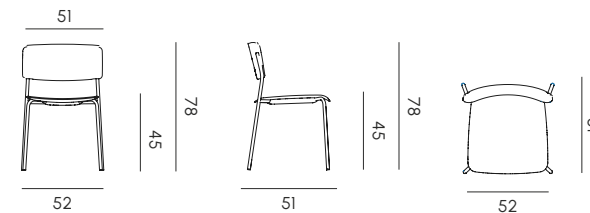

## Sedia con braccioli Chair with armrests

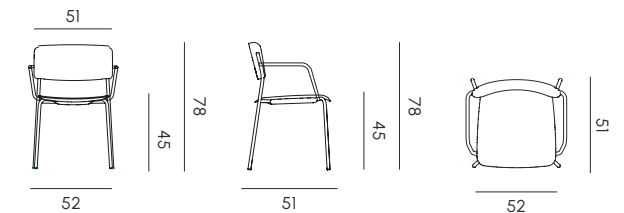

## Sgabello Stool

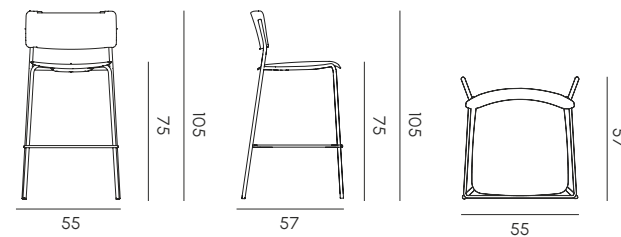

Seduta e schienale	Polipropilene
Struttura	Metallo trattato per esterni
Impilaggio consigliato	
Imballo	4 pz

Seat and backrest	Polypropylene
Structure	Outdoor-treated metal
Recommended stacking method	
Packaging	4 pcs

## Colori e finiture standard Standard colors and finishings

### Finishing - GS



Le immagini dei materiali e dei colori sono indicative, in quanto possono subire lievi variazioni in stampa.  
The materials and colors images serve as a mere indication, as they can vary slightly when printed.

Le immagini dei materiali e dei colori sono indicative, in quanto possono subire lievi variazioni in stampa.  
The materials and colors images serve as a mere indication, as they can vary slightly when printed.

# PAOLA

## Sedia Chair

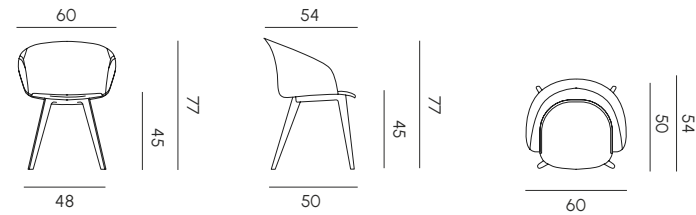

## Cuscino per poltrona da pranzo Fabric cushion for dining armchair

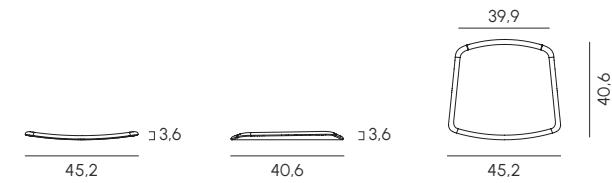

Seduta	Polipropilene
Gambe	Polipropilene + fibre di vetro o plastic-wood
Imbottitura cuscini	Poliuretano sagomato
Rivestimento cuscini	Tessuto idrorepellente per esterni
Imballo	4 pz

Seat	Polypropylene
Legs	Polypropylene + glass fiber or plastic-wood
Cushions upholstery	Shaped polyurethane
Cushions cover	Outdoor water-repellent fabric
Packaging	4 pcs

## Colori e finiture standard Standard colors and finishings

### Seduta e gambe monocolore - Monocolor Seat & legs Polypropylene / Polypropylene + glass fiber



### Gambe della struttura - Structure Legs Polipropilene + fibra di vetro o fibra di legno - Polypropylene + glass fiber or wood fiber

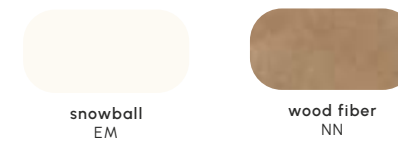

Questi due colori per le gambe possono essere abbinati ai colori della seduta, ottenendo la poltroncina in bicolore. These two colors for the legs can be matched with the colors of the seat, getting the armchair in two-tone.

### Cuscini opzionali - Optional cushions Tessuto - Fabric

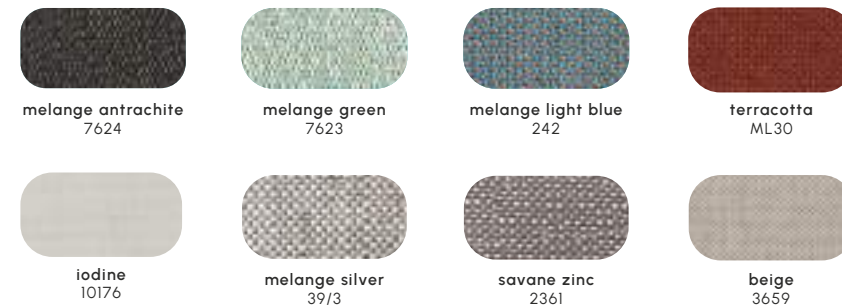

Le immagini dei materiali e dei colori sono indicative, in quanto possono subire lievi variazioni in stampa. The materials and colors images serve as a mere indication, as they can vary slightly when printed.

Le immagini dei materiali e dei colori sono indicative, in quanto possono subire lievi variazioni in stampa. The materials and colors images serve as a mere indication, as they can vary slightly when printed.

# SOFIA

## Poltrona da pranzo e poltrona da pranzo rivestita Dining armchair and upholstered dining armchair

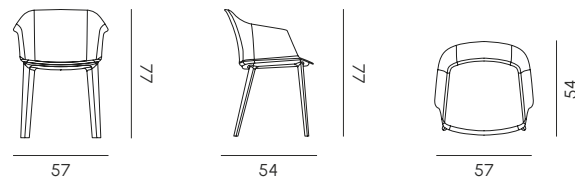

## Cuscino per poltrona da pranzo (non rivestita) Fabric cushion for dining armchair (not upholstered)

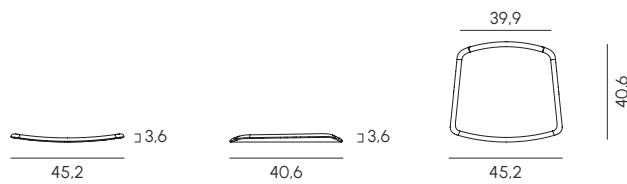

## Poltrona da pranzo con cuscino integrato Dining armchair with integrated cushion

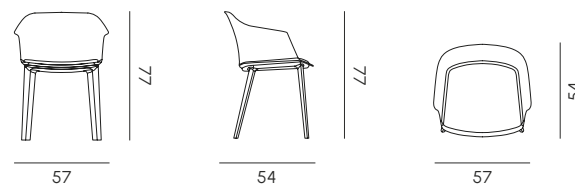

Seduta	Polipropilene
Gambe	Polipropilene + fibre di vetro o plastic-wood
Imbottitura seduta e cuscino	Poliuretano sagomato
Rivestimento seduta e cuscini	Tessuto idrorepellente per esterni

Lotti di vendita 4 pezzi  
Lots for sale 4 pieces

Seat	Polypropylene
Legs	Polypropylene + glass fiber or plastic-wood
Cushion and seat upholstery	Shaped polyurethane
Seat and cushions cover	Outdoor water-repellent fabric

## Colori e finiture standard Standard colors and finishings

### Monocolor Seat & legs Polypropylene / Polypropylene + glass fiber



\*disponibile con seduta esterna in finitura VL  
\*available with external seat in VL finishing

### Structure Legs Polypropylene + glass fiber or wood fiber



Questi 3 colori per le gambe possono essere abbinati ai colori della seduta, ottenendo la poltroncina in bicolore.  
These three colors for the legs can be matched with the colors of the seat, getting the armchair in two-tone.

### Seat coverings \*\* Fabric



\*\*abbinabili con gambe snowball EM / dark NR  
matching with snowball EM / dark NR legs

### Optional cushions Fabric

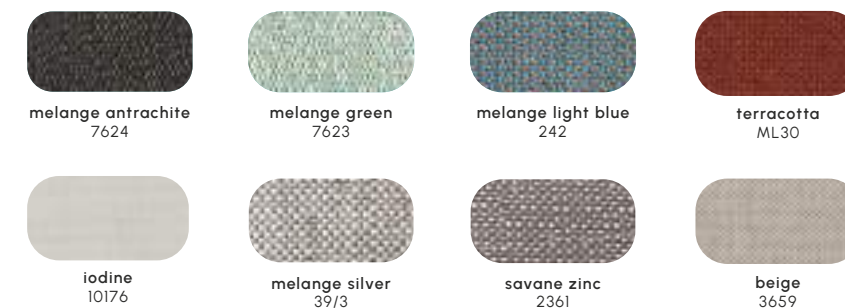

Le immagini dei materiali e dei colori sono indicative, in quanto possono subire lievi variazioni in stampa.  
The materials and colors images serve as a mere indication, as they can vary slightly when printed.

# TINA

## Sedia Chair

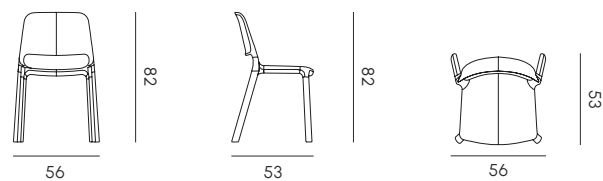

## Sedia con braccioli Chair with armrests

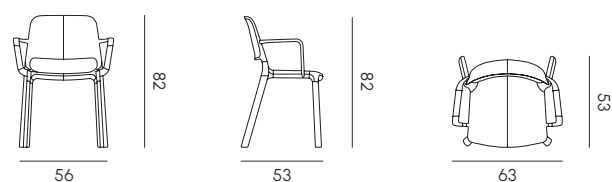

## Sgabello h101 Stool

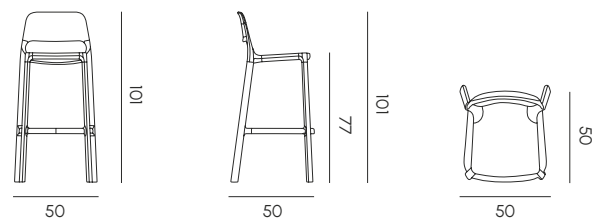

Struttura	Polipropilene + fibre di vetro	Frame	Polypropylene + glass fiber
Piedini	Polipropilene	Feets	Polypropylene

Lotti di vendita 4 pezzi  
Lots for sale 4 pieces

## Colori e finiture standard Standard colors and finishings

### Finishing - GS



Le immagini dei materiali e dei colori sono indicative, in quanto possono subire lievi variazioni in stampa.  
The materials and colors images serve as a mere indication, as they can vary slightly when printed.

# ADA

## Sedia Chair

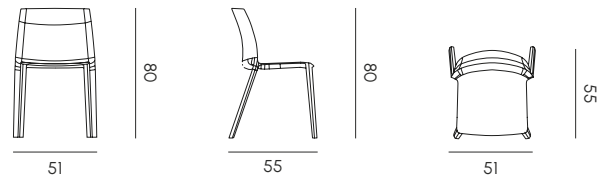

## Sedia con braccioli Chair with armrests

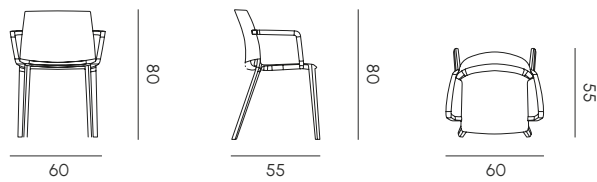

Struttura	Polipropilene + fibre di vetro
Piedini	Polipropilene

Frame	Polypropylene + glass fiber
Feets	Polypropylene

Lotti di vendita 4 pezzi  
Lots for sale 4 pieces

## Colori e finiture standard Standard colors and finishings

### Finishing - GS, VL

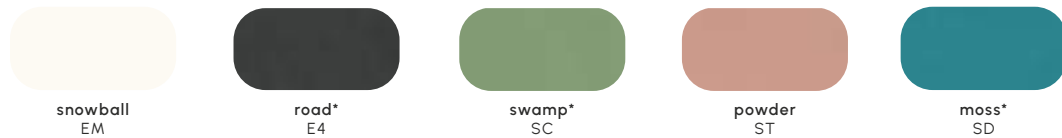

\*disponibile con seduta esterna in finitura VL  
\*available with external seat in VL finishing

Le immagini dei materiali e dei colori sono indicative, in quanto possono subire lievi variazioni in stampa.  
The materials and colors images serve as a mere indication, as they can vary slightly when printed.

# VALE

## Vale modulo Vale module

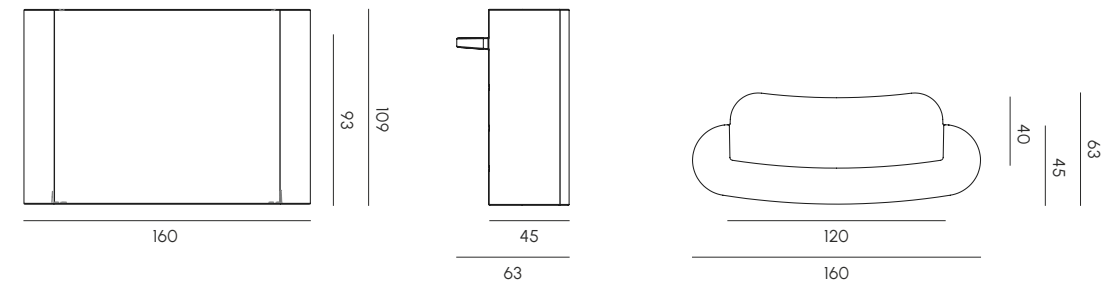

Struttura	Poleasy® 100% riciclabile
Fonte luminosa	predisposto per n. 3 lampadine di tipo E27 LED, max 20W - 230V 50/60Hz indice di protezione: IP44 (non incluse)

Frame	100% recyclable Poleasy®
Light source	Prepared for E27 LED bulb, max 20W - 230V 50/60Hz, protection index: IP44 (not included)

## Colori e finiture standard Standard colors and finishings

### Finishing - IL



### Finishing - VL



\* La quantità minima ordinabile è di 6 pezzi.  
The minimum order quantity is 6 pieces.

Le immagini dei materiali e dei colori sono indicative, in quanto possono subire lievi variazioni in stampa.  
The materials and colors images serve as a mere indication, as they can vary slightly when printed.

# NOVA BAR

By Brogliato Traverso

## Nova modulo lineare Nova straight element

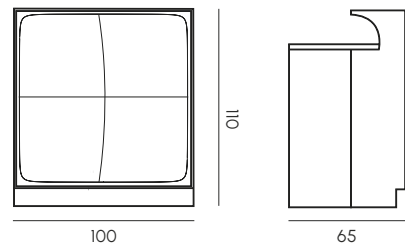

## Nova modulo angolare Nova corner element

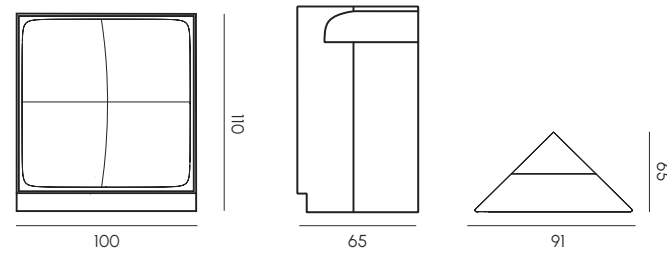

## Nova modulo lineare con cocktail station ABS Nova straight element with ABS cocktail station

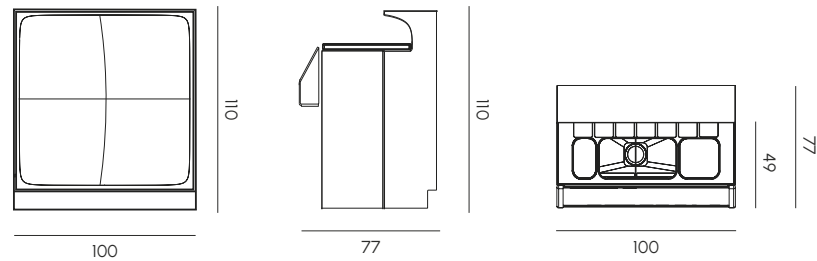

## Sistema di montaggio Assembling System

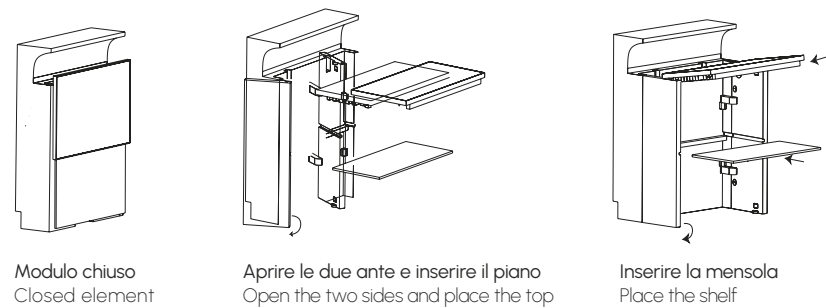

## Misure tridimensionali del bancone Counter three-dimensional measures

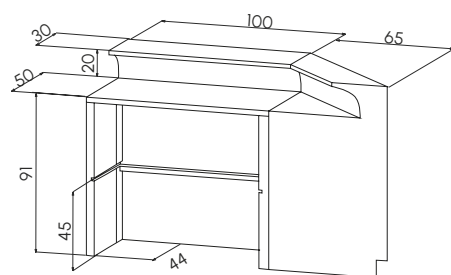

## Misure tridimensionali del bancone con cocktail station Counter three-dimensional measures with cocktail station

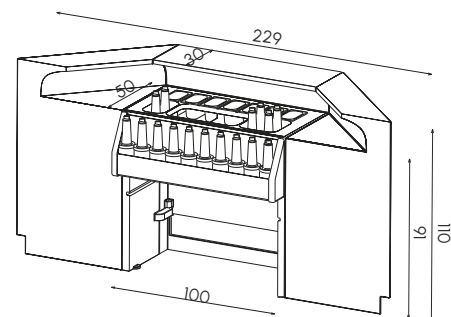

## Caratteristiche di Cocktail station M Cocktail station M features

Realizzata in 2 componenti in ABS PMMA alimentare facile da pulire. Installazione con aggancio rapido sia su Nova e Dublin. Installabile ad incasso a piano. Vasca ghiaccio con capienza fino a circa 60 kg. Separatore amovibile per ghiaccio a cubetti o spezzato. Piletta di scarico. 7 vani per vaschette H100 x L108 x W176 cad. 2 vani portabottiglie interni vasca (2 + 4). Vaschette e bottiglie non sono incluse.

Made of 2 components in food-grade PMMA ABS easy to clean. Installation with quick release both on Nova and Dublin. It can be installed recessed in a worktop. Ice tank with capacity up to about 60 kg. Removable separator for ice in cubes or minced. Drainage pipe. 7 compartments for bowls H100 x L108 x W176 each. 2 internal bottle rack compartments (2 + 4). Bowls and bottles are not included.



## Speed rack Speed rack

Realizzata in ABS PMMA alimentare facile da pulire. Portata fino a 10 bottiglie (le bottiglie non sono incluse). Elemento removibile.

Made of food-grade PMMA ABS easy to clean. Capacity up to 10 bottles (bottles are not included). Removable element.



## Vasca Sink

Rimuovendo il coperchio della cocktail station si può utilizzare la sola vasca portaghiaccio sfruttando la sua capienza fino a 80 Kg max.

Removing the cocktail station lid, you can only use the sink to 80 kgs maximum capacity.

Struttura	Poleasy® 100% riciclabile	Frame	100% recyclable Poleasy®
Piano di lavoro	Poleasy® 100% riciclabile	Working Top	100% recyclable Poleasy®
Cerniere	Poleasy® 100% riciclabile	Hinges	100% recyclable Poleasy®
Cocktail station	ABS Grigio RAL 7035	Cocktail Station	ABS Grey RAL 7035
Kit di illuminazione dove previsto	E27 EXT * oppure RGBW LED 12W ** (controller necessario)	Lighting kit where applicable	E27 EXT * or RGBW LED 12W ** (necessary controller unit)

\* E27 EXT lampadina di tipo E27 LED, max 20W - 230V 50/60Hz indice di protezione: IP44 (non include) E27 LED bulb, max 20W - 230V 50/60Hz, protection index: IP44 (not included)

\*\* RGBW LED 12W Illuminazione: Strip Led 12W, Indice protezione: IP44 Lighting type: Strip Led 12W, Protection index: IP44

## Colori e finiture standard Standard colors and finishings

### Finishing - GS



white  
117

### Finishing - IL



translucent  
110

### Finishing - VL



beige  
804

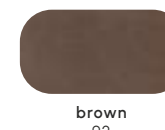

brown  
92

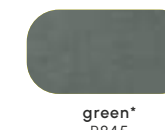

green\*  
P845

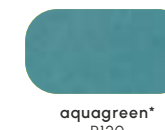

aquagreen\*  
P120



velvet anthracite\*  
210

\* La quantità minima ordinabile è di 6 pezzi.  
The minimum order quantity is 6 pieces.

Le immagini dei materiali e dei colori sono indicative, in quanto possono subire lievi variazioni in stampa.  
The materials and colors images serve as a mere indication, as they can vary slightly when printed.

# DUBLIN

## Dublin modulo lineare Dublin straight element

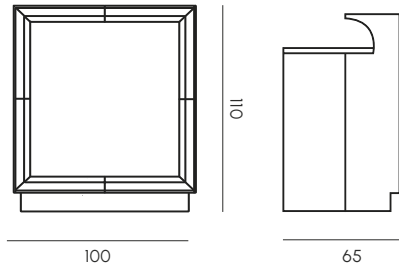

## Dublin modulo angolare Dublin corner element

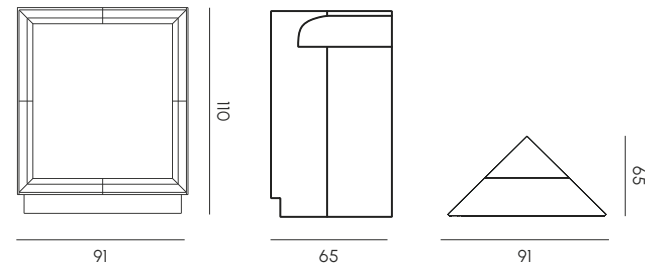

## Dublin modulo lineare con cocktail station ABS Dublin straight element with ABS cocktail station

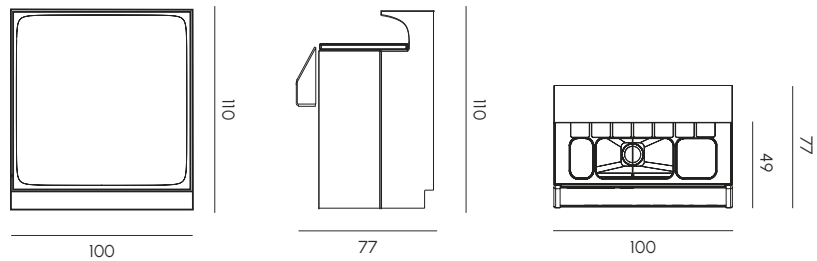

## Sistema di montaggio Assembling System

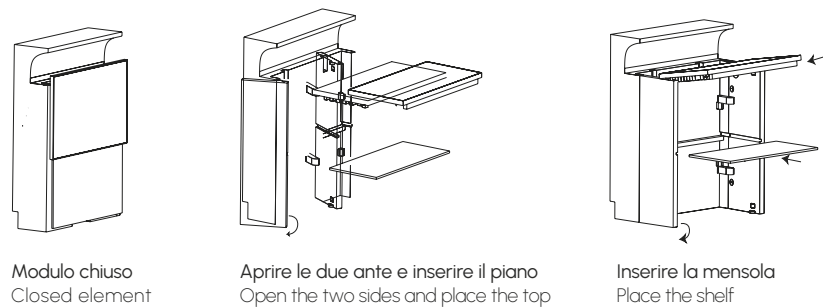

## Misure tridimensionali del bancone Counter three-dimensional measures

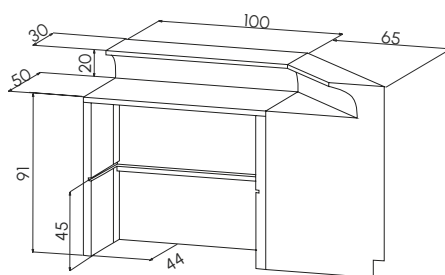

## Misure tridimensionali del bancone con cocktail station Counter three-dimensional measures with cocktail station

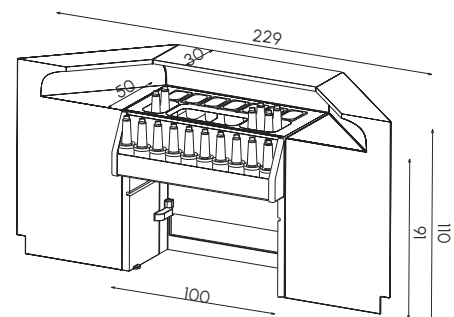

## Caratteristiche di Cocktail station M Cocktail station M features

Realizzata in 2 componenti in ABS PMMA alimentare facile da pulire. Installazione con aggancio rapido sia su Nova e Dublin. Installabile ad incasso a piano. Vasca ghiaccio con capienza fino a circa 60 kg. Separatore amovibile per ghiaccio a cubetti o spezzato. Piletta di scarico. 7 vani per vaschette H100 x L108 x W176 cad. 2 vani portabottiglie interni vasca (2 + 4). Vaschette e bottiglie non sono incluse.

Made of 2 components in food-grade PMMA ABS easy to clean. Installation with quick release both on Nova and Dublin. It can be installed recessed in a worktop. Ice tank with capacity up to about 60 kg. Removable separator for ice in cubes or minced. Drainage pipe. 7 compartments for bowls H100 x L108 x W176 each. 2 internal bottle rack compartments (2 + 4). Bowls and bottles are not included.



## Speed rack Speed rack

Realizzata in ABS PMMA alimentare facile da pulire. Portata fino a 10 bottiglie (le bottiglie non sono incluse). Elemento removibile.

Made of food-grade PMMA ABS easy to clean. Capacity up to 10 bottles (bottles are not included). Removable element.



## Vasca Sink

Rimuovendo il coperchio della cocktail station si può utilizzare la sola vasca portaghiaccio sfruttando la sua capienza fino a 80 Kg max.

Removing the cocktail station lid, you can only use the sink to 80 kgs maximum capacity.

Struttura	Poleasy® 100% riciclabile	Frame	100% recyclable Poleasy®
Piano di lavoro	Poleasy® 100% riciclabile	Working Top	100% recyclable Poleasy®
Cerniere	Poleasy® 100% riciclabile	Hinges	100% recyclable Poleasy®
Cocktail station e rack	ABS Grigio RAL 7035	Cocktail Station and rack	ABS Grey RAL 7035
Kit di illuminazione dove previsto	E27 EXT * oppure RGBW LED 12W ** (controller necessario)	Lighting kit where applicable	E27 EXT * or RGBW LED 12W ** (necessary controller unit)

\* E27 EXT lampadina di tipo E27 LED, max 20W - 230V 50/60Hz indice di protezione: IP44 (non incluse)  
E27 LED bulb, max 20W - 230V 50/60Hz, protection index: IP44 (not included)

\*\* RGBW LED 12W Illuminazione: Strip Led 12W, Indice protezione: IP44  
Lighting type: Strip Led 12W, Protection index: IP44

## Colori e finiture standard Standard colors and finishings

### Finishing - GS



### Finishing - IL



### Finishing - VL



\* La quantità minima ordinabile è di 6 pezzi.  
The minimum order quantity is 6 pieces.

Le immagini dei materiali e dei colori sono indicative, in quanto possono subire lievi variazioni in stampa.  
The materials and colors images serve as a mere indication, as they can vary slightly when printed.

# BARAONDA

## Baraonda modulo lineare Baraonda straight element

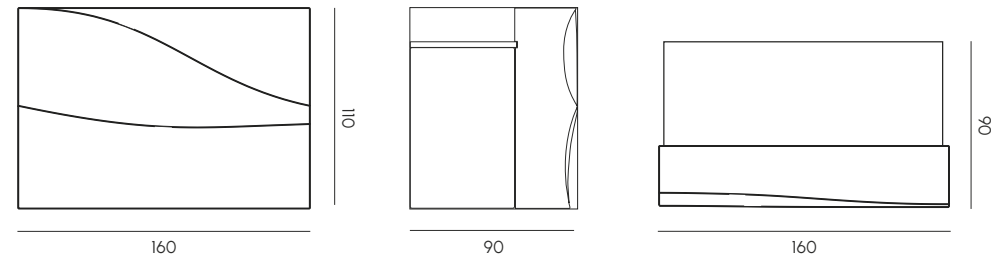

## Baraonda modulo curvo Baraonda curved element

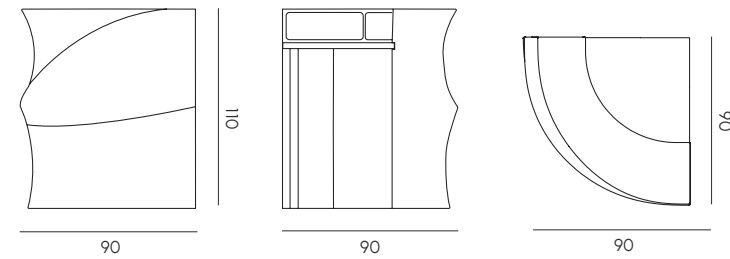

## Baraonda modulo lineare con cocktail station ABS Baraonda straight element with ABS cocktail station

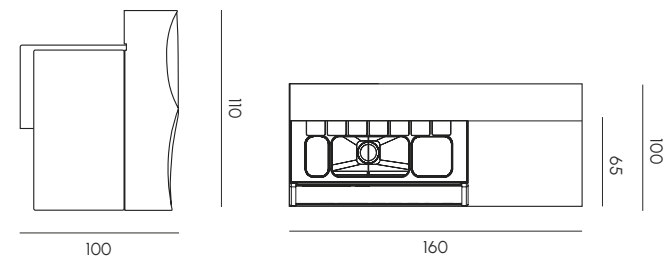

## Misure tridimensionali del modulo lineare e angolare Straight and corner elements three-dimensional measures

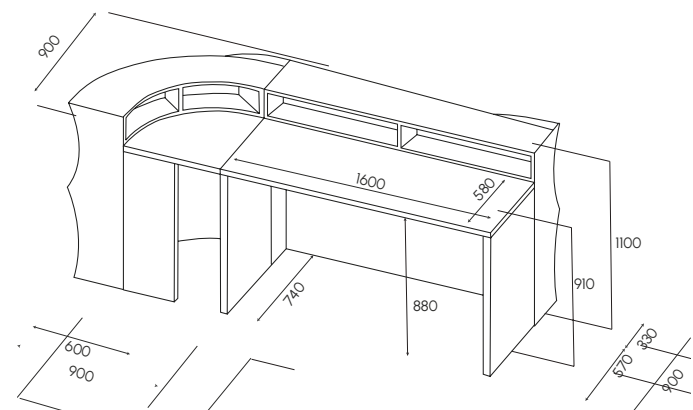

## Display modulo contenitore retrobanco Display back counter element

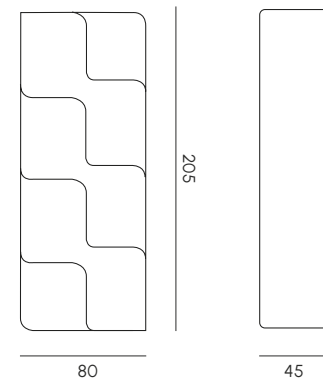

## Sequenza di montaggio Assembling steps



Modulo chiuso  
Closed element



Apertura fianchi  
Sides opening



Kit di illuminazione  
dove previsto

Struttura	Poleasy® 100% riciclabile	Frame	100% recyclable Poleasy®
Piano di lavoro	Laminato	Working Top	Laminate
Cerniere	Inox	Hinges	Inox
Cocktail station e rack	ABS Grigio RAL 7035	Cocktail Station and rack	Grey RAL 703
Posizionamento piano Top positioning	E27 EXT * oppure RGBW LED 12W ** (controller necessario)	Lighting kit where applicable	E27 EXT * or RGBW LED 12W ** (necessary controller unit)

\* E27 EXT 2 pz lampadine di tipo E27 fluorescente compatta, da max 32W - 230V 50/60Hz, indice di protezione: IP44 (non incluse)  
2 pieces E27 compact fluorescent bulb, max 32W - 230V 50/60Hz, protection index: IP44 (not included)

\*\* RGBW LED 12W Illuminazione: Strip Led 36W, Indice protezione: IP44  
Lighting type: Strip Led 36W, Protection index: IP44

## Colori e finiture standard Standard colors and finishings

### Finishing - GS



white  
117

### Finishing - IL

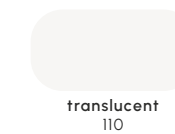

translucent  
110

### Finishing - VL



beige  
804



brown  
92



green\*  
P845



aquagreen\*  
P120



anthracite\*  
210

\* La quantità minima ordinabile è di 6 pezzi.  
The minimum order quantity is 6 pieces.

Le immagini dei materiali e dei colori sono indicative, in quanto possono subire lievi variazioni in stampa.  
The materials and colors images serve as a mere indication, as they can vary slightly when printed.

# SAMURAI

By Moredesign

## Poltrona e pouf Armchair and pouf

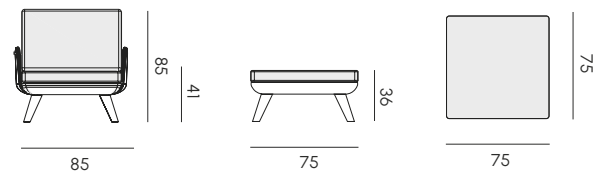

Width: cm 75

## Tavolino Coffee table

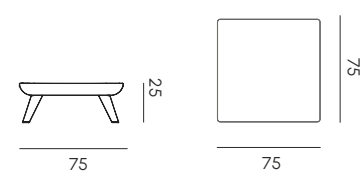

## Divano 2 posti 2 seats sofa

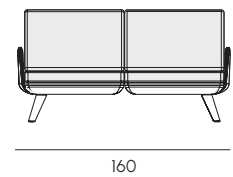

Width: cm 75

## Divano 3 posti 3 seats sofa

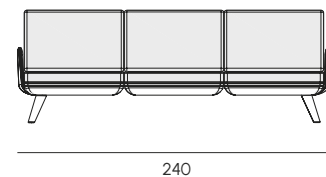

Width: cm 75

## Divano 4 posti con tavolo 4 seats sofa with table

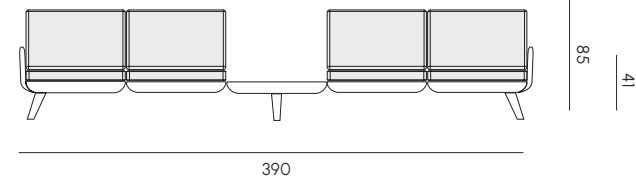

Width: cm 75

## Composizione angolare a 3 posti 3 seats corner set

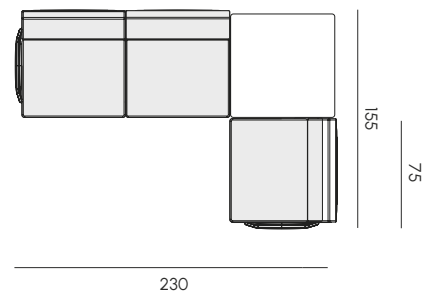

Height: cm 85 / 41 seat

## Composizione angolare a 4 posti 4 seats corner set

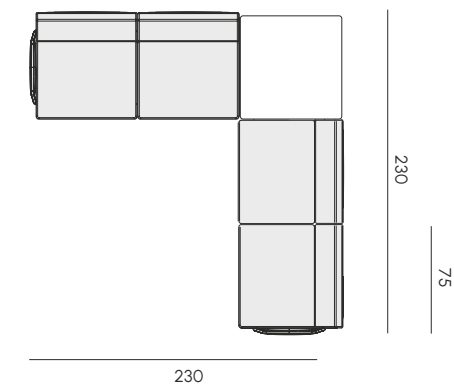

Height: cm 85 / 41 seat

Struttura sedute	Poleasy® 100% riciclabile
Aggancio sedute	Alluminio
Imbottitura	Poliuretano sagomato
Rivestimento Baseline	Tessuto idrorepellente per esterni
Membrana idrofilica solo per versione Plusline	Tessuto impermeabile e traspirante
Rivestimento Plusline	Tessuto per esterni
Gambe	Anima di alluminio rivestita in Poleasy®
Copertura impermeabile	Poliestere con superficie resinata

Frame seats	100% recyclable Poleasy®
Seats anchoring	Aluminium
Upholstery	Shaped polyurethane
Baseline cover	Outdoor water-repellent fabric
Hydrophilic membrane only for Plusline version	Waterproof and breathable fabric
Plusline cover	Outdoor fabric
Feet	Poleasy® coated aluminium core
Waterproof cove cloth	Polyester with external resin surface

## Colori e finiture standard Standard colors and finishings

### Structure Poleasy®

#### Basic - GS



#### Velvet - VL

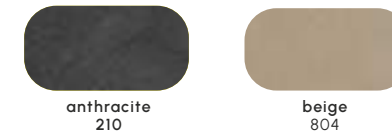

#### Covering Baseline version Fabric

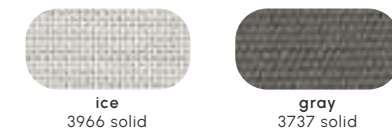

#### Covering Plusline version Fabric

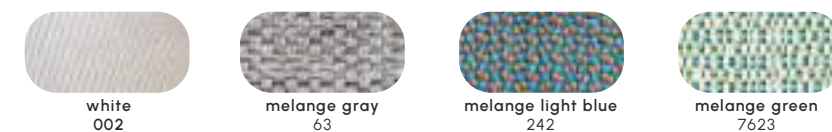

Le immagini dei materiali e dei colori sono indicative, in quanto possono subire lievi variazioni in stampa.  
The materials and colors images serve as a mere indication, as they can vary slightly when printed.

# CHICO

By Moredesign

**Poltrona**  
Armchair

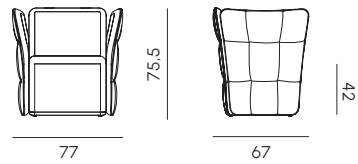

**Divano 2 posti**  
2 seats sofa

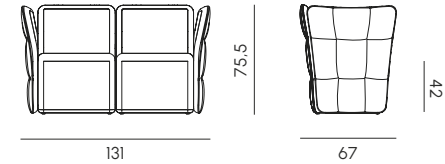

**Divano 3 posti**  
3 seats sofa

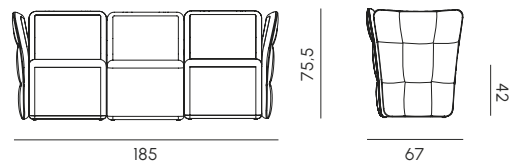

**Tavolino 2054**  
Coffee table

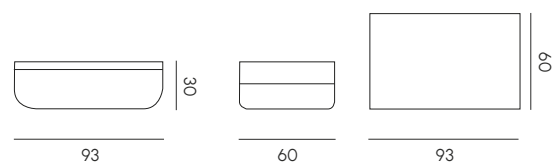

\* Optional cuscineria.  
\* Cushion set optional

Struttura	Poleasy® 100% riciclabile
Rivestimento cuscini	Tessuto idrorepellente per esterni
Imbottitura cuscini	Poliuretano sagomato

Frame	100% recyclable Poleasy®
Cushions cover	Outdoor water-repellent fabric
Cushions upholstery	Shaped polyurethane

## Colori e finiture standard

Standard colors and finishings

### Finishing - GS



### Finishing - VL



\* La quantità minima ordinabile è di 6 pezzi.  
The minimum order quantity is 6 pieces.

### Optional cushions

Fabric



# NOVA SET

By Brogliato Traverso

**Poltrona**  
Armchair

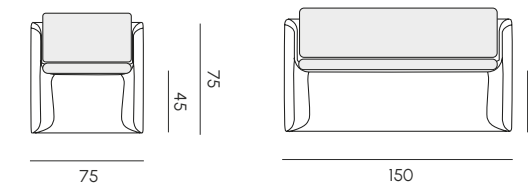

**Divano S**  
Sofa S

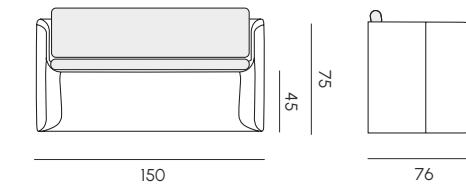

**Tavolino 2054**  
Coffee table

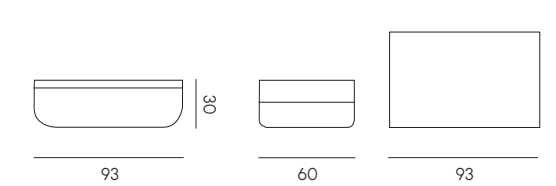

**Divano XL**  
Sofa XL

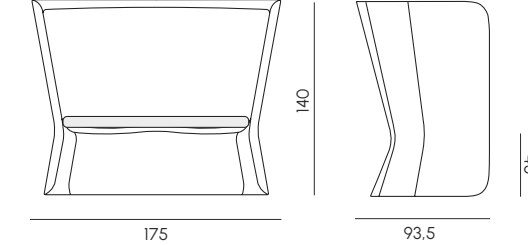

**Panca**  
Bench

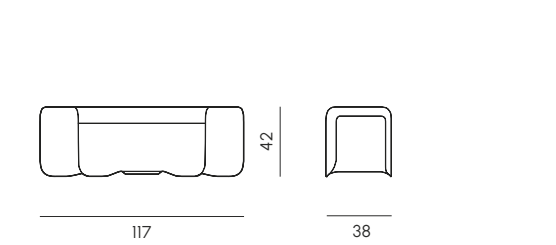

Struttura	Poleasy® 100% riciclabile
Rivestimento cuscini	Tessuto idrorepellente per esterni
Imbottitura cuscini	Poliuretano sagomato

Frame	100% recyclable Poleasy®
Cushions cover	Outdoor water-repellent fabric
Cushions upholstery	Shaped polyurethane

\* Optional cuscineria  
\* Cushion set optional

## Colori e finiture standard

Standard colors and finishings

### Finishing - GS

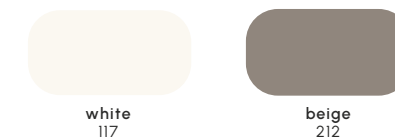

### Finishing - VL



\* La quantità minima ordinabile è di 6 pezzi.  
The minimum order quantity is 6 pieces.

### Optional cushions

Fabric



# LILY

By Moredesign

## Sedia Chair

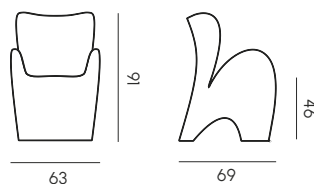

## Poltrona Armchair

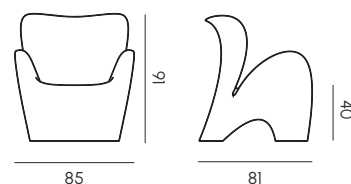

## Divano Sofa

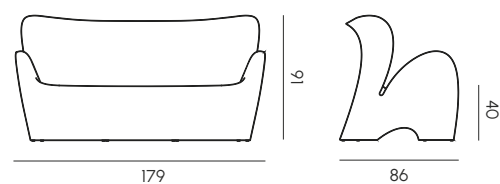

\* Optional cuscineria.  
\* Cushion set optional

## Tavolino con o senza luce

Coffee table with or without light

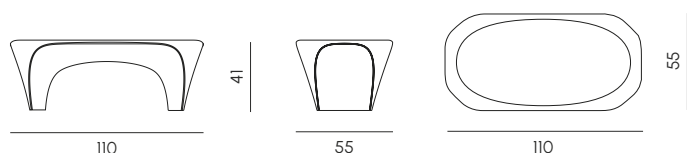

## Tavolino con ice box con o senza luce

Ice-box coffee table with or without light

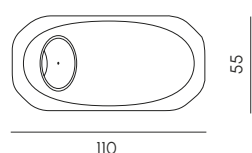

Struttura	Poleasy® 100% riciclabile
Rivestimento cuscini	Tessuto idrorepellente per esterni
Imbottitura cuscini	Poliuretano sagomato
Fonte luminosa solo per tavolino	LED RGBW 3,8W
Metodo di ricarica	Induzione elettrica al litio
Tempo / durata di ricarica	4-5 h / 8-10 h
Lunghezza cavo	1,5 m
Switch	Telecomando

Frame	100% recyclable Poleasy®
Cushions cover	Outdoor water-repellent fabric
Cushions upholstery	Shaped polyurethane
Light source only for coffee table	LED RGBW 3,8W
Recharging method	Lithium electric induction
Recharging / Duration time	4-5 h / 8-10 h
Recharging cable length	1,5 m
Switch	Remote control

## Colori e finiture standard

Standard colors and finishings

### Basic - GS

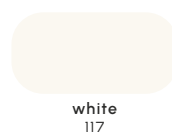

### Basic - IL (only for coffee table)



### Velvet - VL



### Optional cushions Fabric



\* La quantità minima ordinabile è di 6 pezzi.  
The minimum order quantity is 6 pieces.

# MODÌ

By Moredesign

## Poltrona e pouf Armchair and pouf

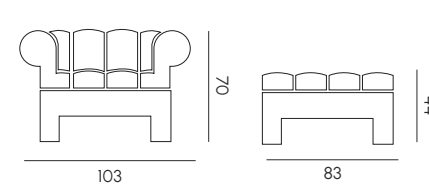

Width: cm 62

## Divano Sofa

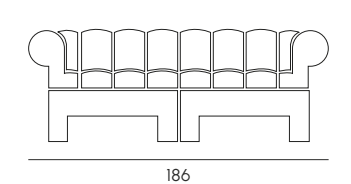

Width: cm 62

## Modulo sinistro, centro, destro con bracciolo

Left, core and right module with armrest

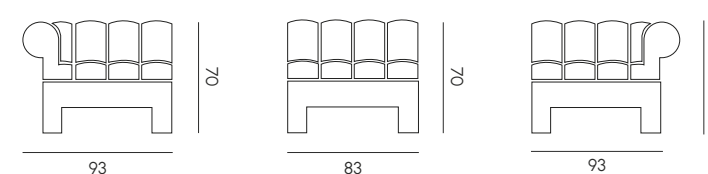

Width: cm 62

## Tavolino con piano in vetro

Coffee table with glass top

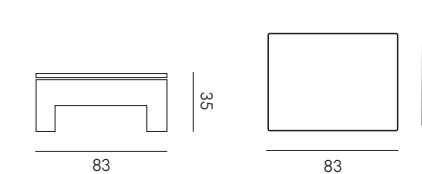

\*\* Modì non è adatto per gli agenti atmosferici diretti  
Modì is not suitable for direct weathering

Struttura	Poleasy® 100% riciclabile
Imbottitura moduli	Poliuretano sagomato
Rivestimento moduli	Finta pelle per esterni
Top tavolino	Vetro extrachiaro acidato temperato
Telo a copertura impermeabile	Poliestere con superficie resinata

Frame	100% recyclable Poleasy®
Modules upholstery	Shaped polyurethane
Modules covering	Outdoor imitation leather
Top coffee table	Extra-clear frosted tempered glass
Waterproof cover cloth	Polyester with external resin surface

## Colori e finiture standard

Standard colors and finishings

### Basic - GS

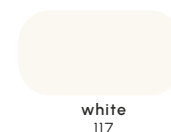

### Upholstered modules Outdoor Eco-leather



### Top Glass

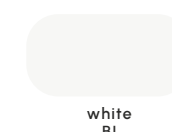

# IRIS

By Marco Maran

## Poltrona Armchair

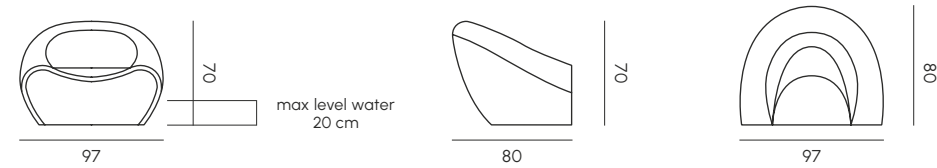

## Tavolino / Sgabello Coffee table / Stool

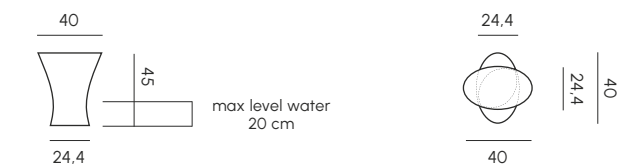

## Tavolo Table

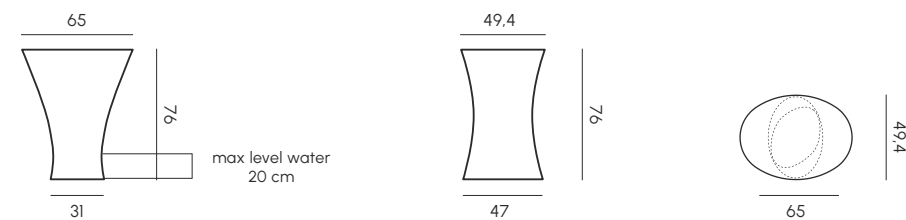

Struttura	Poleasy® 100% riciclabile	Frame	100% recyclable Poleasy®
-----------	---------------------------	-------	--------------------------

Possibilità di utilizzare gli articoli in acqua acquistando la versione ITW ad immersione  
Possibility of using the items in water by purchasing the ITW immersion version

## Colori e finiture standard Standard colors and finishings

### Finishing - GS

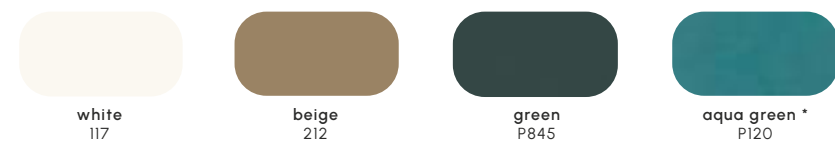

### Finishing - VL



\* La quantità minima ordinabile è di 6 pezzi.  
The minimum order quantity is 6 pieces.

# COMMUNITY SET (TEDDY + RHONDA)

By Moredesign

## Community set con e senza luce Community set with and without light

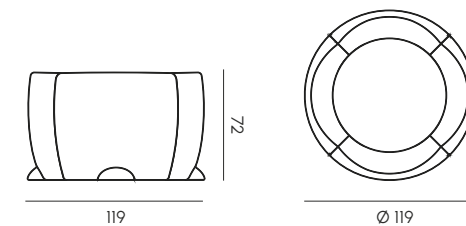

### Componenti: Components:

## Tavolo Teddy con e senza luce Teddy table with and without light

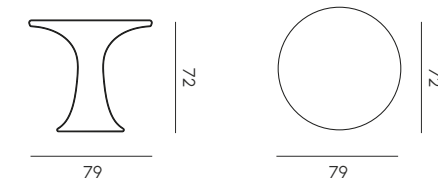

## Poltroncina da pranzo Rhonda Rhonda dining armchair

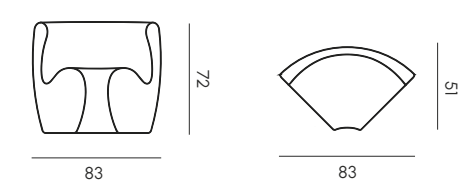

Struttura	Poleasy® 100% riciclabile	Frame	100% recyclable Poleasy®
Fonte luminosa solo per tavolino	LED RGBW 3,8W	Light source only for coffee table	LED RGBW 3,8W
Metodo di ricarica	Induzione elettrica al litio	Recharging method	Lithium electric induction
Tempo / durata di ricarica	4-5 h / 8-10 h	Recharging / Duration time	4-5 h / 8-10 h
Lunghezza cavo	1,5 m	Recharging cable length	1,5 m
Switch	Telecomando	Switch	Remote control

## Colori e finiture standard Standard colors and finishings

### Basic - GS

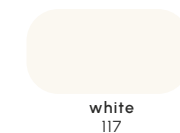

### Basic - IL (only for table)



# MR LEM

By Moredesign

## Sgabello Stool

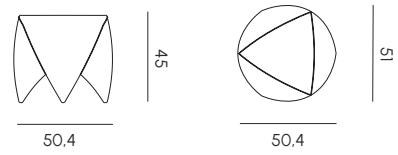

Struttura	Poleasy® 100% riciclabile	Frame	100% recyclable Poleasy®
-----------	---------------------------	-------	--------------------------

### Colori e finiture standard Standard colors and finishings

#### Basic - GS



# PANDORA

By Brogliato Traverso

## Sgabello S Stool S

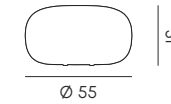

## Sgabello M Stool M

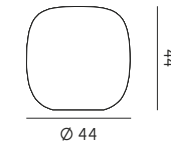

## Sgabello L Stool L

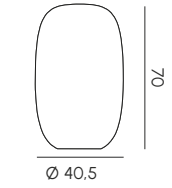

## Tavolino Coffee table

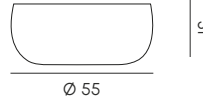

## Vaso S Pot S

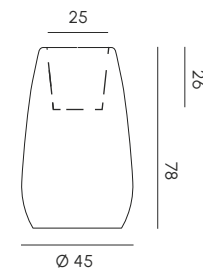

## Vaso M Pot M

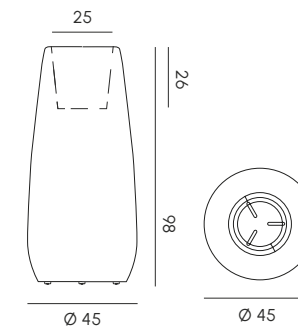

## Fioriera/ Ice-box Planter/ Ice-box

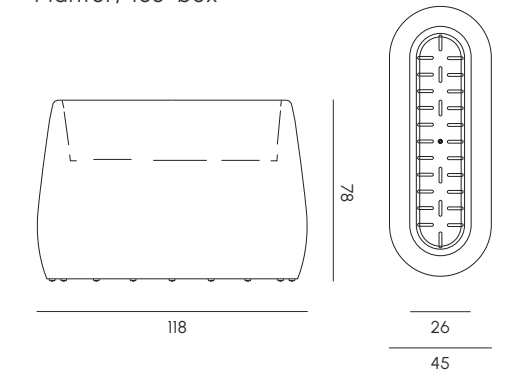

Struttura	Poleasy® 100% riciclabile	Frame	100% recyclable Poleasy®
Fonte luminosa vasi	N° 1 o 2 lampadine E27 LED (non fornite) max 20W - 230V 50/60Hz in base alla misura	Pods light source	N° 1-2 E27 LED bulbs (not included) max 20W - 230V 50/60Hz depending by the size
Alimentazione	110-240V 50/60Hz	Power supply	110-240V 50/60Hz
Indice di protezione cavo di ricarica	IP44	Recharging cable protection index	IP44
Lunghezza cavo	2 m con spina	Recharging cable length	2m with plug
Switch	Spina	Switch	Plug

\* per sgabelli e tavolino luminoso vedi pagina 288  
For stools and light-up table, see page 288

### Colori e finiture standard Standard colors and finishings

#### Finishing - GS

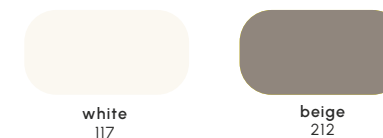

#### Finishing - IL



# LIBERTY

By Moredesign

**Sgabello L**  
Stool L

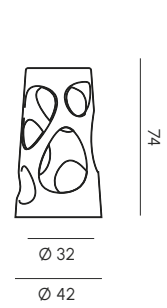

**Fusto tavolo XL**  
Table base XL

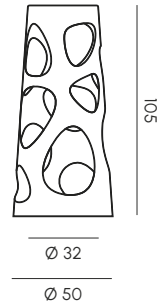

**Piano per tavolo Ø 70**  
Ø 70 table top

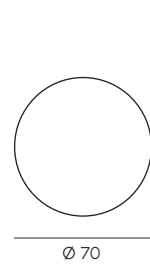

Struttura	Poleasy® 100% riciclabile
Top	HPL

Frame	100% recyclable Poleasy®
Top	HPL

Possibilità di utilizzare gli articoli in acqua acquistando la versione ITW ad immersione  
Possibility of using the items in water by purchasing the ITW immersion version

**Colori e finiture standard**  
Standard colors and finishings

**Finishing - GS**

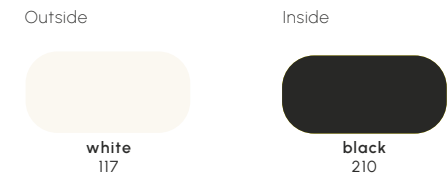

**Table tops**  
HPL

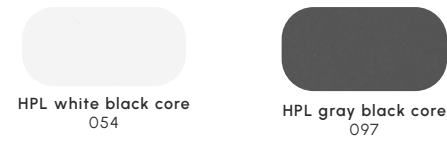

# OXFORD

By Brogliato Traverso

**Sgabello**  
Stool

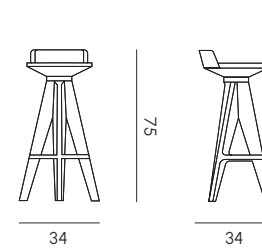

**Tavolo**  
Table

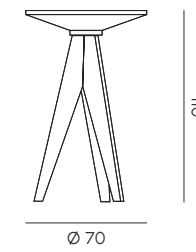

Struttura	Poleasy® 100% riciclabile
-----------	---------------------------

Frame	100% recyclable Poleasy®
-------	--------------------------

**Colori e finiture standard**  
Standard colors and finishings

**Finishing - GS**



# CLOE

By Moredesign

**Lettino**  
Sunbed

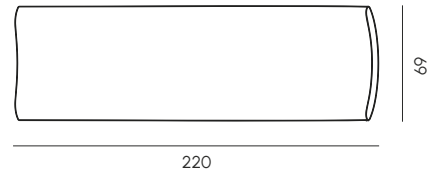
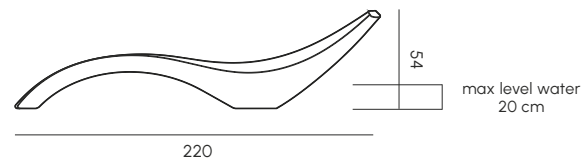

**Telo in spugna**  
Sponge towel

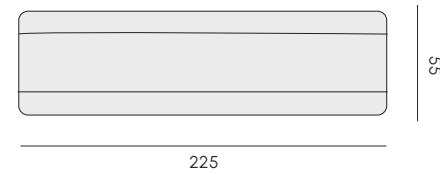
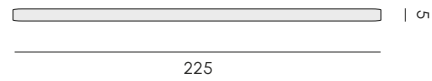

Struttura	Poleasy® 100% riciclabile
Telo in spugna	100% cotone

Frame	100% recyclable Poleasy®
Sponge Towel	100% cotton

Possibilità di utilizzare gli articoli in acqua acquistando la versione ITW ad immersione  
Possibility of using the items in water by purchasing the ITW immersion version

**Colori e finiture standard**  
Standard colors and finishings

**Finishing - GS**

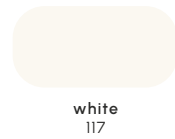

**Optional Sponge Towel**  
Fabric



Le immagini dei materiali e dei colori sono indicative, in quanto possono subire lievi variazioni in stampa.  
The materials and colors images serve as a mere indication, as they can vary slightly when printed.

# ZOE

By Moredisgn

**Lettino**  
Sunbed

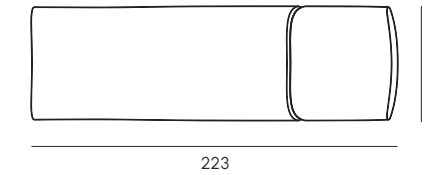
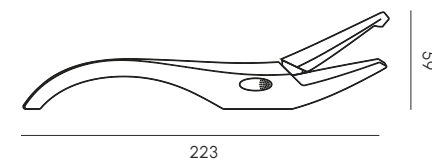

**Telo in spugna**  
Sponge towel

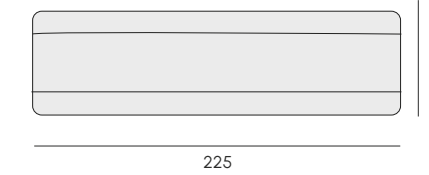
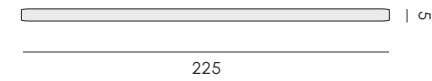

Struttura	Poleasy® 100% riciclabile
Telo in spugna	100% cotone

Frame	100% recyclable Poleasy®
Sponge Towel	100% cotton

**Colori e finiture standard**  
Standard colors and finishings

**Finishing - GS**



**Optional Sponge Towel**  
Fabric



Le immagini dei materiali e dei colori sono indicative, in quanto possono subire lievi variazioni in stampa.  
The materials and colors images serve as a mere indication, as they can vary slightly when printed.

# DYNO

By Moredesign

**Dyno doccia**  
Dyno shower

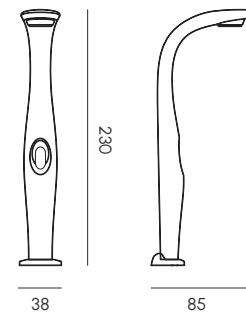

**Paw base per doccia**  
Paw shower base

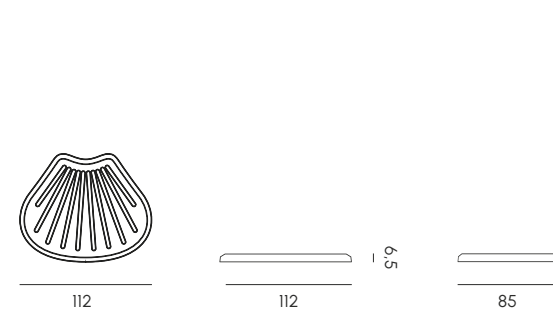

Struttura	Poleasy® 100% riciclabile	Frame	100% recyclable Poleasy®
Struttura base PAW	ABS bianco	PAW base frame	White ABS
Soffione, Mixer e Coprimixer, Copribase	ABS cromato	Shower head, Mixer tap and Mixer cover, Base cover	Chrome-plating ABS

**Colori e finiture standard**  
Standard colors and finishings

**Shower**  
Finishing - GS



**Paw**  
Finishing - High-gloss



# GEM

By Paolo Cappello

**Vaso S**  
Pot S

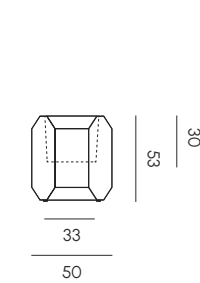

**Vaso M**  
Pot M

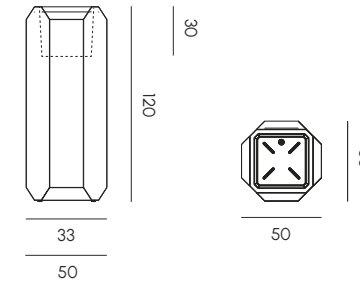

**Fioriera, ice-box**  
Planter, ice-box

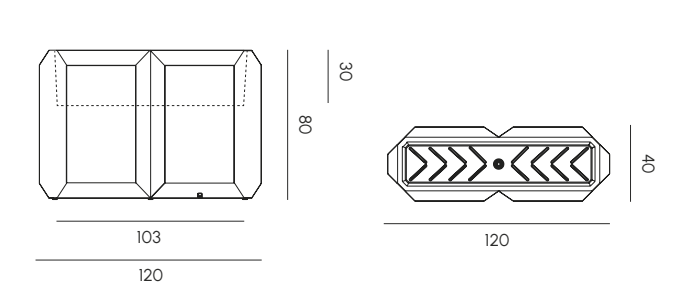

Struttura	Poleasy® 100% riciclabile	Frame	100% recyclable Poleasy®
Fonte luminosa	N° 1 o 2 lampadine E27 LED, max 20W-230V 50/60 Hz in base alla misura (non fornite)	Light source	N° 1 or 2 E27 LED bulb, max 20W-230V 50/60 Hz depending on the size (not included)
Alimentazione	110-240V 50/60Hz	Power Supply	110-240V 50/60Hz
Indice di protezione cavo di ricarica	IP44	Cable IP	IP44
Lunghezza cavo	2 m	Cable length	2 m
Switch	Spina	Switch	Plug

**Colori e finiture standard**  
Standard colors and finishings

**Finishing - GS**

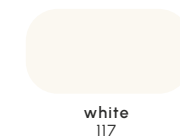

**Finishing - VL**



\* Per le finiture Velvet green, aquagreen e anthracite la quantità minima ordinabile è di 6 pezzi  
For Velvet green, aquagreen and anthracite finishes the minimum order quantity is 6 pieces

**Finishing - IL**



Le immagini dei materiali e dei colori sono indicative, in quanto possono subire lievi variazioni in stampa.  
The materials and colors images serve as a mere indication, as they can vary slightly when printed.

# SKIN

By Isabella Lovero + Enrico Bosa

Vaso S  
Pot S

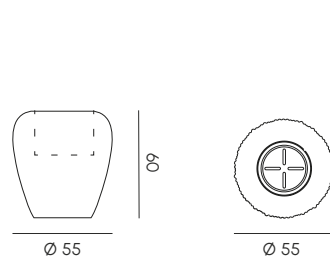

Vaso L  
Pot L

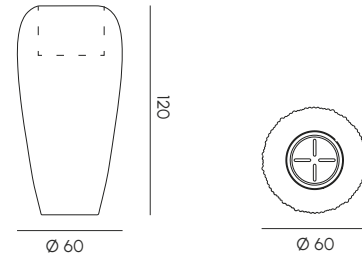

Struttura	Poleasy® 100% riciclabile
Fonte luminosa	N° 1 lampadine E27 LED, max 20W-230V 50/60 Hz in base alla misura (non fornite)
Alimentazione	100-240V 50/60Hz
Indice di protezione cavo di ricarica	IP44
Lunghezza cavo	2 m (cavo bianco con spina)
Switch	Spina

Frame	100% recyclable Poleasy®
Light source	N° 1 E27 LED bulb, max 20W-230V 50/60 Hz depending on the size (not included)
Power Supply	100-240V 50/60Hz
Cable IP	IP44
Cable length	2 m (white cable with plug)
Switch	Plug

## Colori e finiture standard Standard colors and finishings

### Finishing - GS

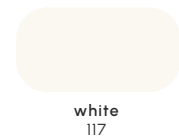

### OS - Oxidized



\* La quantità minima ordinabile è di 6 pezzi  
The minimum order quantity is 6 pieces

### Finishing - IL



Le immagini dei materiali e dei colori sono indicative, in quanto possono subire lievi variazioni in stampa.  
The materials and colors images serve as a mere indication, as they can vary slightly when printed.

# TAO

By Rosaria Copeta

Vaso S  
Pot S

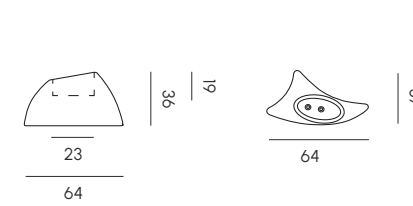

Vaso M  
Pot M

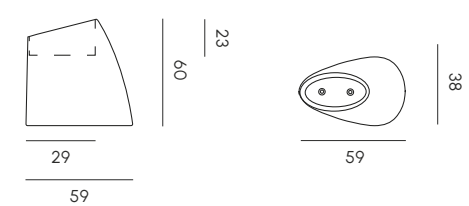

## Fioriera, ice-box Planter, ice-box

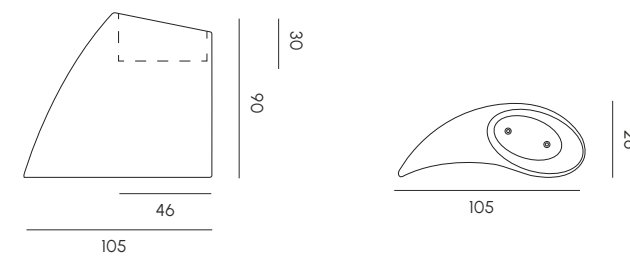

Struttura	Poleasy® 100% riciclabile
-----------	---------------------------

Frame	100% recyclable Poleasy®
-------	--------------------------

## Colori e finiture standard Standard colors and finishings

### Finishing - VL



\* Per le finiture Velvet green, aquagreen e anthracite la quantità minima ordinabile è di 6 pezzi  
For Velvet green, aquagreen and anthracite finishes the minimum order quantity is 6 pieces

Le immagini dei materiali e dei colori sono indicative, in quanto possono subire lievi variazioni in stampa.  
The materials and colors images serve as a mere indication, as they can vary slightly when printed.

# FRAMES

By Brogliato Traverso

## Separatore Divider

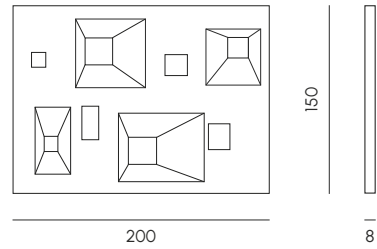

Struttura e zavorre Poleasy® 100% riciclabile

la zavorra può essere riempita d'acqua o sabbia.  
The ballast can be filled with water or sand.

## Zavorre Ballasts

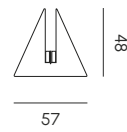

Frame 100% recyclable Poleasy®

## Colori e finiture standard Standard colors and finishings

### Finishing - GS

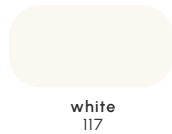

Le immagini dei materiali e dei colori sono indicative, in quanto possono subire lievi variazioni in stampa.  
The materials and colors images serve as a mere indication, as they can vary slightly when printed.

# BAGIGIO

By Simone Micheli

## Modulo Ba\_Gigio Bagigio element



## Base autoportante e piastra fissaggio Self-supporting base and fixing plate

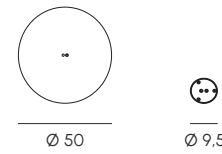

## Modulo Gigio Gigio element



## Tubo Pipe

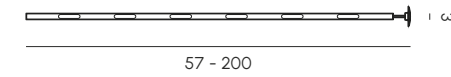

## Schema di montaggio Assembling scheme

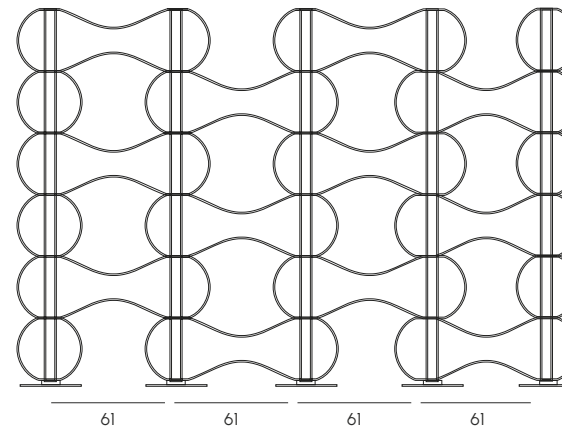

Struttura	Poleasy® 100% riciclabile
Base autoportante	Ferro 360 laccato a polveri RAL 9016
Piastra fissaggio	Acciaio 316 passivato (per ambienti marini) con trattamento di cataforesi
Tubi	FE verniciato con trattamento di cataforesi o su richiesta per ambienti marini in Acciaio 316 passivato

Frame	100% riciclabile Poleasy®
Self-supporting base	RAL 9016 Powder-coated iron 360
Fixing plate	316 passivated steel (for marine spaces) with treatment of cataphoresis
Pipes	FE painted with cataphoresis treatment or on request for marine environments in passivated 316 steel

## Colori e finiture standard Standard colors and finishings

### Finishing - GS

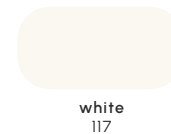

# FLAMINGO

By Moredesign

**Paletto**  
Pole

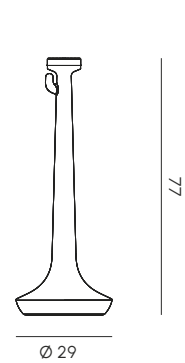

**Dispenser**  
Dispenser

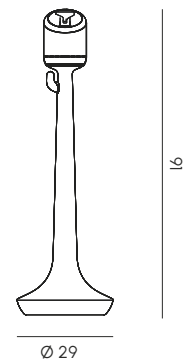

Massima capacità del dispenser: 1 L  
Dispenser maximum capacity: 1 L

**Posacenere**  
Ashtray

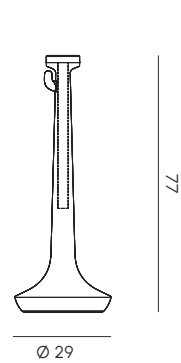

Capacità massima del portacenere:  
300 sigarette  
Ashtray maximum capacity:  
300 cigarettes

**Bobina di corda**  
Rope coil



Diametro della corda: 14 mm  
Lunghezza massima della corda: 100 m  
Rope width: 14 mm  
Rope maximum length: 100 m

Struttura	Poleasy® 100% riciclabile
Corda	Poliestere

Frame	100% recyclable Poleasy®
Rope	Polyester

**Colori e finiture standard**  
Standard colors and finishings

**Finishing - GS**



white  
117

**Rope**  
Polyester



neutral

# TINO

By Isabella Lovero + Enrico Bosa

**Sedia per bambini**  
Kids chair

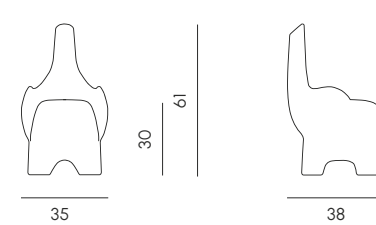

Struttura	Poleasy® 100% riciclabile
Fonte luminosa	LED RGBW 3.8W 1000mA
Potenza assorbita	Adattatore: AC: 100-240V 50/60Hz DC: 5V
Metodo di ricarica	Induzione elettrica al litio
Tempo di ricarica	4-5 h
Durata di carica	8-10 h
Indice di protezione lampada	IP66
Indice di protezione cavo di ricarica	IP20
Lunghezza cavo	1,5 m
Switch	Telecomando

Lotti di vendita 2 pezzi  
Lots for sale 2 pieces

**Colori e finiture standard**  
Standard colors and finishings

**Finishing - GS**



white  
117

**Finishing - IL**



translucent  
110

Frame	100% recyclable Poleasy®
Light source	LED RGBW 3.8W 1000mA
Power Input	Adaptor: AC: 100-240V 50/60Hz DC: 5V
Recharging method	Lithium electric induction
Recharging time	4-5 h
Duration time	8-10 h
Lamp protection index	IP66
Recharging cable protection index	IP20
Recharging cable length	1,5 m
Switch	Remote control

Le immagini dei materiali e dei colori sono indicative, in quanto possono subire lievi variazioni in stampa.  
The materials and colors images serve as a mere indication, as they can vary slightly when printed.

# CRAZY HEAD

By CrousCalogero

**Appendiabiti portacasco**  
Clothes and helmet holder

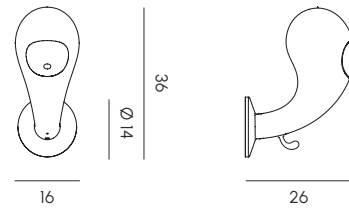

Struttura	Poleasy® 100% riciclabile	Frame	100% recyclable Poleasy®
-----------	---------------------------	-------	--------------------------

Lotti di vendita 2 pezzi  
Lots for sale 2 pieces

**Colori e finiture standard**  
Standard colors and finishings

Finishing - GS

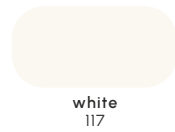

# LIGHT TECH INDEX

BY CATEGORY

Sospensioni Pendant lamps		Lampade da terra Standing lamps		Lampade galleggianti Floating lamps	
NEFOS	285	AGATA	277	PANDORA	282
		AGATA WOOD	278	BABYLOVE	284
		AMPOULE	279		
		BABYLOVE	284		
		HOLLYWOOD	280		
		JOY	275		
		PANDORA	282		
		PENELOPE	276		
		PINA	274		
LIGHT TALES	286	TULIP	281		

Le immagini dei materiali e dei colori sono indicative, in quanto possono subire lievi variazioni in stampa.  
The materials and colors images serve as a mere indication, as they can vary slightly when printed.

# PINA

By Moredesign

**Pina lampada**  
Pina lamp

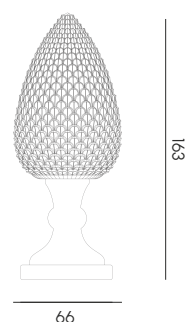

	IL E27	RGBW BATTERIA
Diffusore / base	Poleasy® 100% riciclabile	Poleasy® 100% riciclabile
Fonte luminosa	N°4 lampadine di tipo E27 LED max 20W-230V 50/60Hz (non fornite)	LED RGBW 3.8W 2000mA
Potenza assorbita		A ca Adattatore AC: 100-240V - 50/60 Hz DC: 7.5V vo
Alimentazione / Metodo di ricarica	110-240V - 50/60 Hz	A cavo
Tempo di ricarica		4-5 h
Durata di ricarica		8-10 h
Indice di protezione cavo	IP44	IP20
Indice di protezione lampada		IP66
Lunghezza cavo	2 M con spina	1,5 m
Switch	Spina	Telecomando

**Colori e finiture standard**  
Standard colors and finishings

**Lampshade**  
Finishing IL

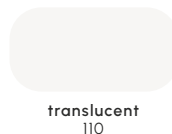

**Base**

**Finishing GS**

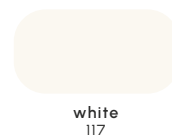

**Finishing VL**



# JOY

By Lanzavecchia + Wai

**Lampada da terra con base in marmo**  
Standing lamp with marble base

**Lampada da terra fissata a terra (con viti)**  
Ground-mounted floor lamp (screw-fixed)

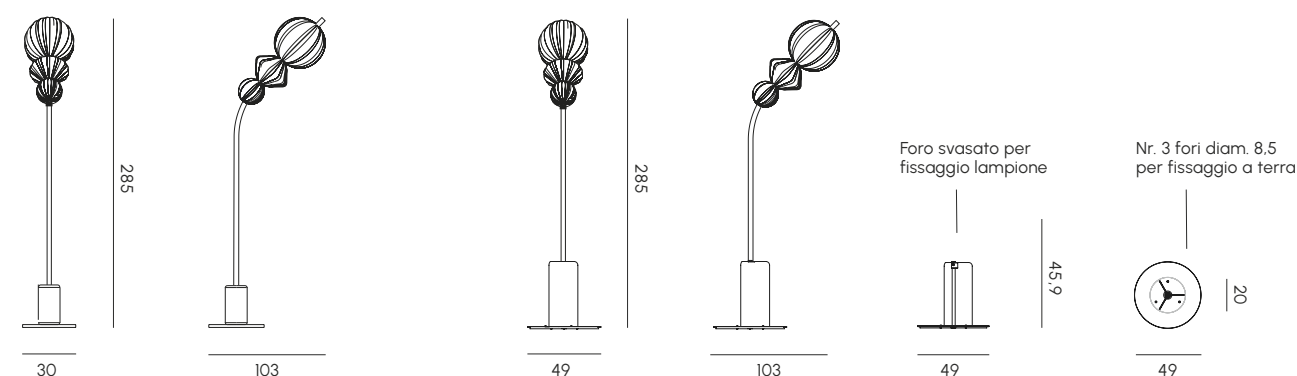

Diffusore	Poleasy® 100% riciclabile
Struttura	Metallo con fondo protettivo a cataforesi verniciato a polveri
Basamento (dove previsto)	Marmo Filetto Rosso di Trani
Fonte luminosa	230V 50/60Hz 24V per max 75W strips LED 3000K 5000 lm
Alimentazione	110-240V 24V
Indice di protezione cavo	IP44
Lunghezza cavo	2,5 m con spina
Switch	Spina

Lampshade	100% recyclable Poleasy®
Frame	Powder-coated metal with cataphoresis protection fund
Base (where applicable)	Trani Filetto Rosso marble
Light source	230V 50/60Hz 24V for max 75W strips LED 3000K 5000 lm
Power supply	110-240V 24V
Cable IP	IP44
Cable Length	2,5 m with plug
Switch	Plug

**Colori standard**  
Standard colors

**Lampshade**  
Finishing IL



Le immagini dei materiali e dei colori sono indicative, in quanto possono subire lievi variazioni in stampa. The materials and colors images serve as a mere indication, as they can vary slightly when printed.

# PENELOPE

By Moredesign

**Lampada da terra**  
Standing lamp

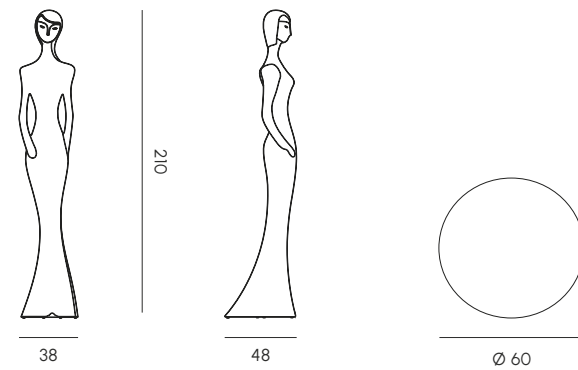

**Basamento autoportante\***  
Self-supporting base

Diffusore	Poleasy® 100% riciclabile
Fonte luminosa	STRIP LED 5050 RGB+6000K
Alimentazione	AC: 100-240V 50/60Hz DC: 24V 5.0A
Indice di protezione cavo	IP44
Lunghezza cavo	2 m
Switch	Spina, telecomando
Basamento autoportante	Alluminio verniciato

Lampshade	100% recyclable Poleasy®
Light source	STRIP LED 5050 RGB+6000K
Power supply	AC: 100-240V 50/60Hz DC: 24V 5.0A
Cable IP	IP44
Cable Length	2 m
Switch	Plug, remote control
Self-supporting base	Painted aluminium

Le staffe di ancoraggio di Penelope sono incluse nella versione outdoor  
Penelope's anchor brackets are included in outdoor version

\*Ideale in ambienti ventosi, molto frequentati o senza fissaggio a pavimento  
Ideal for windy areas, high-traffic spaces, or when floor fixing is not possible.

**Colori standard**  
Standard colors

**Finishing - IL**

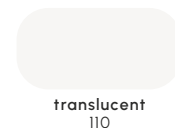

**Self-supporting base**  
Aluminium

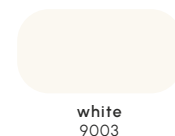

Le immagini dei materiali e dei colori sono indicative, in quanto possono subire lievi variazioni in stampa.  
The materials and colors images serve as a mere indication, as they can vary slightly when printed.

# AGATA

By Moredesign

**Lampada da terra**  
Standing lamp

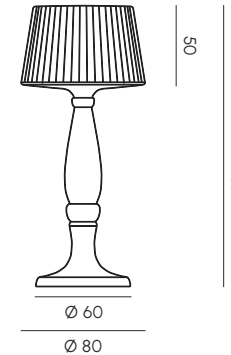

Diffusore	Poleasy® 100% riciclabile
Fonte luminosa	N°5 lampadina di tipo E27 LED max 20W-230V 50/60Hz in base alla misura (non fornite)
Alimentazione	110-240V - 50/60 Hz
Indice di protezione cavo	IP44
Lunghezza cavo	2,5 m con spina
Switch	Spina

Lampshade	100% recyclable Poleasy®
Light source	N°5 E27 LED bulbs max 20W-230V 50/60Hz depending on the size (not included)
Power supply	110-240V - 50/60 Hz
Cable IP	IP44
Cable Length	2,5 m with plug
Switch	Plug

Le staffe di ancoraggio di Agata sono incluse nella versione outdoor  
Agata's anchor brackets are included in outdoor version

**Colori standard**  
Standard colors

**Finishing - IL**



Le immagini dei materiali e dei colori sono indicative, in quanto possono subire lievi variazioni in stampa.  
The materials and colors images serve as a mere indication, as they can vary slightly when printed.

# AGATA WOOD

By Moredesign

## Lampada da terra Standing lamp

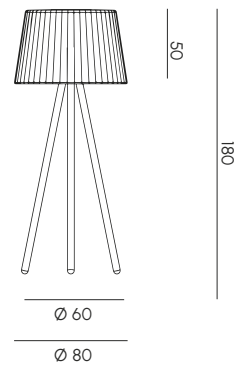

Diffusore	Poleasy® 100% riciclabile	Lampshade	100% recyclable Poleasy®
Basamento	Legno Kotò	Base	Kotò wood
Fonte luminosa	N°1 lampadina di tipo E27 LED max 20W-230V 50/60Hz in base alla misura (non fornite)	Light source	N°1 E27 LED bulb max 20W-230V 50/60Hz depending on the size (not included)
Alimentazione	110-240V - 50/60 Hz	Power supply	110-240V - 50/60 Hz
Indice di protezione cavo	IP44	Cable IP	IP44
Lunghezza cavo	2 m	Cable Length	2 m
Switch	Spina	Switch	Plug

### Colori standard Standard colors

#### Finishing - IL



Le immagini dei materiali e dei colori sono indicative, in quanto possono subire lievi variazioni in stampa.  
The materials and colors images serve as a mere indication, as they can vary slightly when printed.

# AMPOULE

By Broglito Traverso

## Lampada da terra Standing lamp

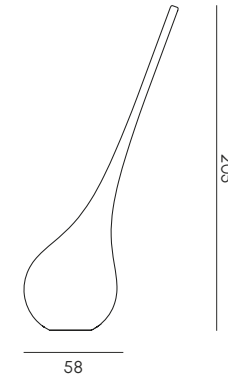

	IL E27	RGBW BATTERIA	IL E27	RGBW BATTERY
Diffusore	Poleasy® 100% riciclabile	Poleasy® 100% riciclabile	Lampshade	100% recyclable Poleasy®
Fonte luminosa	N°1 lampadina di tipo E27 LED max 20W-230V 50/60Hz in base alla misura (non fornite)	LED RGBW 3.8W 2000mA	Light source	N°5 E27 LED bulbs max 20W-230V 50/60Hz (not included) LED RGBW 3.8W 2000mA
Potenza assorbita		A ca Adattatore AC: 100-240V - 50/60 Hz DC: 7.5V vo	Power supply	Adaptor AC: 100-240V - 50/60 Hz DC: 7.5V
Alimentazione / Metodo di ricarica	110-240V - 50/60 Hz	A cavo	Power Source / Charging Method	110-240V - 50/60 Hz Rechargeable cable
Tempo di ricarica		4-5 h	Recharging time	4-5 h
Durata di ricarica		8-10 h	Duration time	8-10 h
Indice di protezione cavo	IP44	IP20	Cable protection index	IP44 IP20
Indice di protezione lampada		IP66	Lamp protection index	IP66
Lunghezza cavo	2 M con spina	1,5 m	Cable Length	2 m with plug 1,5 m
Switch	Spina	Telecomando	Switch	Plug Remote control

### Colori standard Standard colors

#### Finishing - IL



Le immagini dei materiali e dei colori sono indicative, in quanto possono subire lievi variazioni in stampa.  
The materials and colors images serve as a mere indication, as they can vary slightly when printed.

# HOLLYWOOD

By Brogliato Traverso

Lampada da terra  
Standing lamp

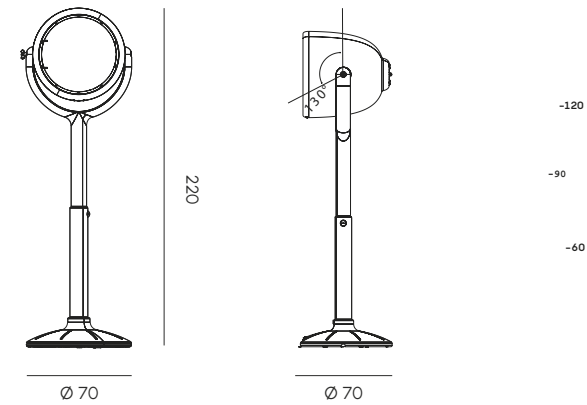

Diffusore	Poleasy® 100% riciclabile	Lampshade	100% recyclable Poleasy®
Fonte luminosa	Piastra Led 33W 3000K - 5000 lm CRI80	Light source	33W LED plate 3000K - 5000 lm CRI80
Alimentazione	110-270V 50-60Hz	Power supply	110-270V 50-60Hz
Indice di protezione cavo	IP44	Cable IP	IP44
Lunghezza cavo	3 m con spina	Cable Length	3 m with plug
Switch	Spina	Switch	Plug

Colori standard  
Standard colors

Finishing - GS



white  
117

# TULIP

By Moredesign

Lampada da terra  
Standing lamp

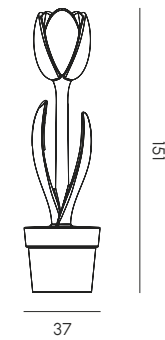

Diffusore	Poleasy® 100% riciclabile	Lampshade	100% recyclable Poleasy®
Fonte luminosa	Strip LED bianco 3000K	Light source	Warm white LED strip 3000K
Alimentazione	AC 100/230 24V 35W	Power supply	AC 100/230 24V 35W
Indice di protezione cavo	IP44	Cable IP	IP44
Lunghezza cavo	4 m con spina	Cable Length	4 m with plug
Switch	spina	Switch	plug

Colori standard  
Standard colors

Finishing - IL

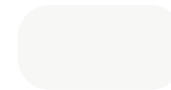

translucent  
110

Le immagini dei materiali e dei colori sono indicative, in quanto possono subire lievi variazioni in stampa.  
The materials and colors images serve as a mere indication, as they can vary slightly when printed.

# PANDORA LIGHTS

By Brogliato Traverso

## Lampada da terra e galleggiante S\* Floor and floating S lamp

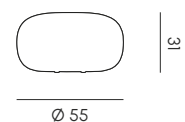

## Lampada da terra M Floor M lamp

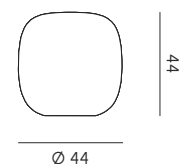

## Lampada da terra L Floor L lamp

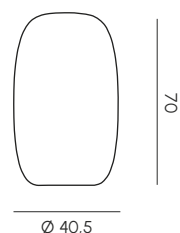

## Lampada piantana S Standing S lamp

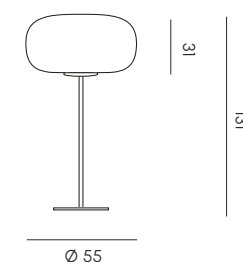

## Lampada piantana M Standing M lamp

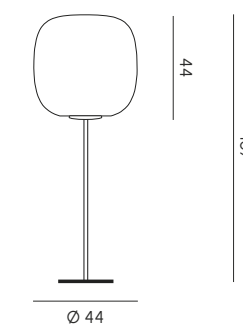

## Lampada piantana L Standing L lamp

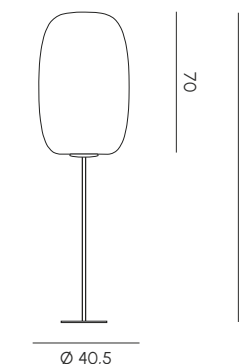

	IL E27	RGBW BATTERIA
Diffusore	Poleasy® 100% riciclabile	Poleasy® 100% riciclabile
Fonte luminosa	N°1 lampadina di tipo E27 LED max 20W-230V 50/60Hz in base alla misura (non fornite)	LED RGBW 3.8W 2000mA
Potenza assorbita		A ca Adattatore AC: 100-240V - 50/60 Hz DC: 7.5V vo
Alimentazione / Metodo di ricarica	110-240V - 50/60 Hz	A cavo
Tempo di ricarica		4-5 h
Durata di ricarica		8-10 h
Indice di protezione cavo	IP44	IP20
Indice di protezione lampada		IP66
Lunghezza cavo	2 M con spina	1,5 m
Switch	Spina	Telecomando

	IL E27	RGBW BATTERIA
Lampshade	100% recyclable Poleasy®	100% recyclable Poleasy®
Light source	N°5 E27 LED bulbs max 20W-230V 50/60Hz (not included)	LED RGBW 3.8W 2000mA
Power supply		Adaptor AC: 100-240V - 50/60 Hz DC: 7.5V
Power Source / Charging Method	110-240V - 50/60 Hz	Rechargeable cable
Recharging time		4-5 h
Duration time		8-10 h
Cable protection index	IP44	IP20
Lamp protection index		IP66
Cable Length	2 m with plug	1,5 m
Switch	Plug	Remote control

Diffusore	Poleasy®
Struttura e basamento	Alluminio verniciato a polveri epossidiche
Fonte luminosa	N°1 lampadina di tipo E27 LED max 20W-230V 50/60Hz (non fornite)
Alimentazione	110-240V - 50/60 Hz
Indice di protezione cavo	IP44
Lunghezza cavo	2 m con spina
Switch	Spina

Lampshade	Poleasy®
Frame and base	Epoxy powder coated aluminium
Light source	N°1 E27 LED bulb max 20W-230V 50/60Hz (not included)
Power supply	110-240V - 50/60 Hz
Cable IP	IP44
Cable Length	2 m with plug
Switch	Plug

### Colori standard Standard colors

#### Finishing - IL



### Colori standard Standard colors

#### Finishing - IL

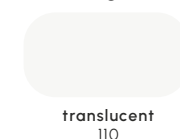

### Frame and base Aluminium

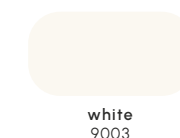

Le immagini dei materiali e dei colori sono indicative, in quanto possono subire lievi variazioni in stampa.  
The materials and colors images serve as a mere indication, as they can vary slightly when printed.

# BABYLOVE WATERPROOF

By MY YOUR

**Lampada galleggiante waterproof**  
Floating waterproof lamp

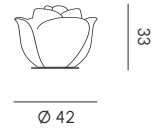

Diffusore	Poleasy® 100% riciclabile
Base	Acciaio inox
Fonte luminosa	LED RGBW 3.8W 2000mA
Potenza assorbita	Adattatore AC: 100-240V - 50/60 Hz DC: 7.5V
Metodo di ricarica	Induzione elettrica al Litio
Tempo di ricarica	4-5 h
Durata di ricarica	8-10 h
Indice di protezione lampada	IP66
Indice di protezione cavo	IP20
Lunghezza cavo	1.5 m
Switch	Telecomando

Lampshade	100% recyclable Poleasy®
Base	Stainless steel
Light source	LED RGBW 3.8W 2000mA
Power supply	Adaptor AC: 100-240V - 50/60 Hz DC: 7.5V
Recharging method	Lithium electrical induction
Recharging time	4-5 h
Duration time	8-10 h
lamp protection index	IP66
Cable IP	IP20
Cable Length	1.5 m
Switch	Remote control

**Colori standard**  
Standard colors

**Finishing - IL**



translucent  
110

Le immagini dei materiali e dei colori sono indicative, in quanto possono subire lievi variazioni in stampa.  
The materials and colors images serve as a mere indication, as they can vary slightly when printed.

# NEFOS

By Paolo De Lucchi

**Lampada sospensione M**  
Pendant lamp M

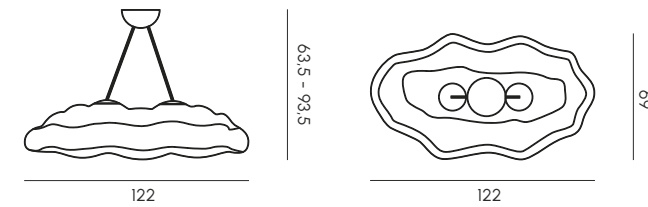

**Lampada sospensione L**  
Pendant lamp L

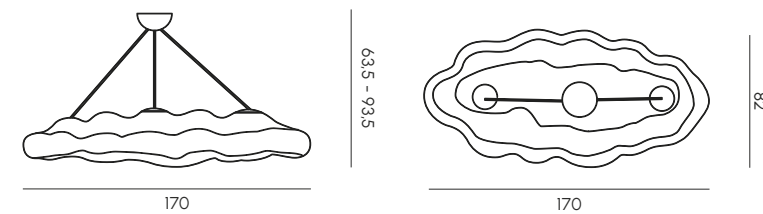

Diffusore	Poleasy® 100% riciclabile
Fonte luminosa	N°2 o 3 lampadine di tipo E27 LED max 20W-230V 50/60Hz in base alla misura della lampada (non fornite)
Alimentazione	230V - 50/60 Hz
Indice di protezione cavo	IP44
Lunghezza cavo	2 m
Switch	Rosone

Lampshade	100% recyclable Poleasy®
Light source	N°2 or 3 E27 LED bulbs max 20W-230V 50/60Hz depending on the lamp size (not included)
Power supply	230V - 50/60 Hz
Cable IP	IP44
Cable Length	2 m
Switch	Canopy box

**Colori standard**  
Standard colors

**Finishing - IL**



translucent  
110

Le immagini dei materiali e dei colori sono indicative, in quanto possono subire lievi variazioni in stampa.  
The materials and colors images serve as a mere indication, as they can vary slightly when printed.

# LIGHT TALES

By Ale Giardini

**Mobi lampada da tavolo**  
Mobi table lamp

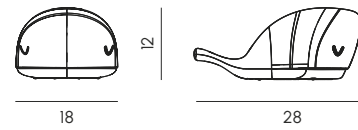

**Mobi XL lampada da terra**  
Mobi XL floor lamp

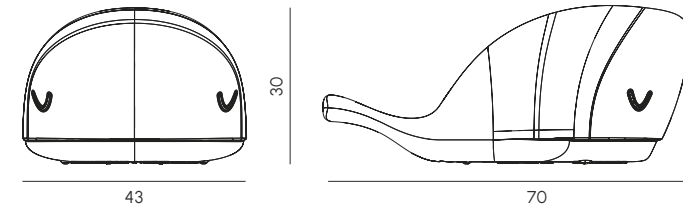

**Cat lampada da tavolo**  
Cat table lamp

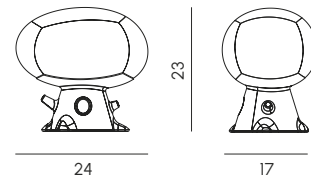

**Tin lampada da tavolo**  
Tin table lamp

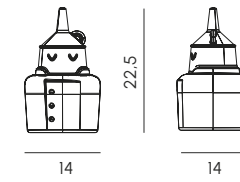

**Rose lampada da tavolo**  
Rose table lamp

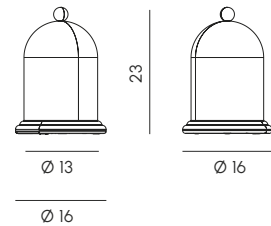

**Tri lampada da tavolo**  
Tri table lamp

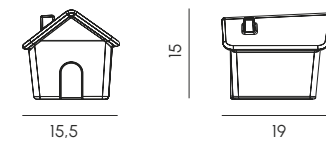

	IL G9 led 1W o E27	RGBW BATTERIA
Diffusore	Poleasy® 100% riciclabile	Poleasy® 100% riciclabile
Fonte luminosa Mobi XL	N°1 lampadina di tipo E27 LED max 20W-230V 50/60Hz (non fornita)	LED RGBW 3.8W 2000mA
Fonte luminosa Mobi, Cat, Tin, Rose, Tri	N°1 lampadina G9 led (inclusa)	LED RGBW 3.8W 2000mA
Potenza assorbita		A ca Adattatore AC: 100-240V - 50/60 Hz DC: 7.5V vo
Alimentazione / Metodo di ricarica	110-240V - 50/60 Hz	A cavo
Tempo di ricarica		4-5 h
Durata di ricarica		8-10 h
Indice di protezione cavo	IP44	IP20
Indice di protezione lampada		IP66
Lunghezza cavo	2 M con spina	1,5 m
Switch	Spina	Telecomando

	IL E27	RGBW BATTERY
Lampshade	100% recyclable Poleasy®	100% recyclable Poleasy®
Light source Mobi XL	N°1 E27 LED bulbs max 20W-230V 50/60Hz (not included)	LED RGBW 3.8W 2000mA
Light source Mobi, Cat, Tin, Rose, Tri	N°1 G9 LED bulb (included)	LED RGBW 3.8W 2000mA
Power supply		Adaptor AC: 100-240V - 50/60 Hz DC: 7.5V
Power Source / Charging Method	110-240V - 50/60 Hz	Rechargeable cable
Recharging time		4-5 h
Duration time		8-10 h
Cable protection index	IP44	IP20
Lamp protection index		IP66
Cable Length	2 m with plug	1,5 m
Switch	Plug	Remote control

**Colori standard**  
Standard colors

**Finishing - IL**



# COLORI E FINITURE COLORS AND FINISHINGS

## POLIPROPILENE POLYPROPYLENE

### Emma chair and stool

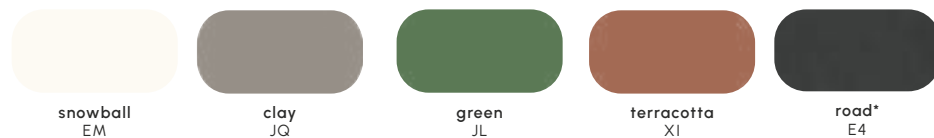

### Karenn chairs and stool

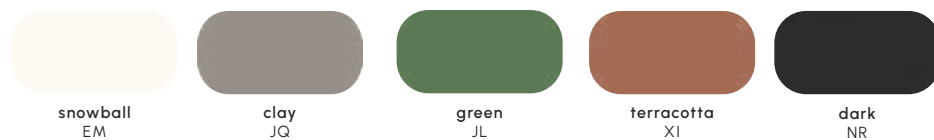

### Paola armchair



### Sofia armchair



### Ada chairs



### Tina chairs and stool



## TESSUTO FABRIC

### Paola - Sofia

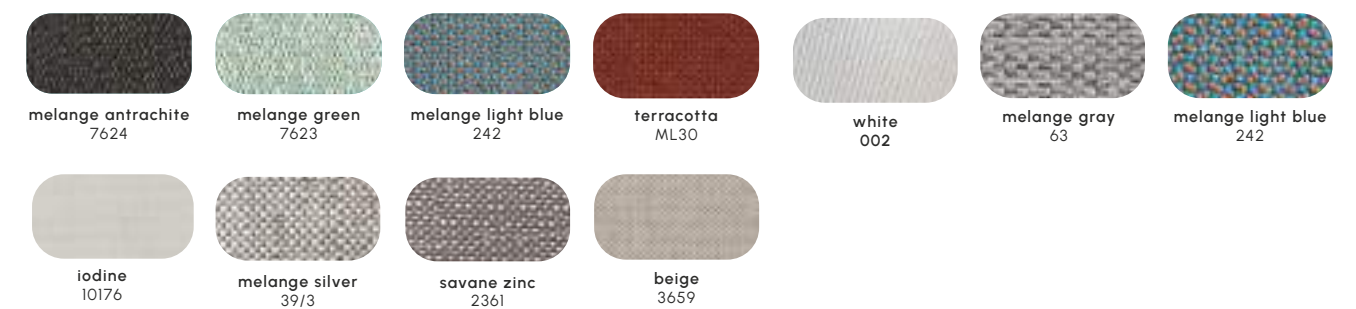

### Nova - Chico - cuscini opzionali

## TOP HPL HPL TOP

### Liberty

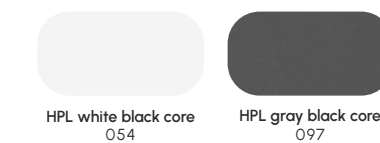

## ECOPELLE PER ESTERNI OUTDOOR ECO-LEATHER

### Modi



## POLEASY® - FINITURA GS (basico) POLEASY® - FINISHING GS (basic)

Nova Bar - Dublin - Baraonda - Samurai - Chico - Nova Set - Lily - Modi Base - Iris - Set community - Lem - Pandora Stools - Liberty - Oxford - Cloe - Zoe - Dyno - Gem - Pandora Pods - Skin - Frames - Bagigio - Flamingo - Tino - Crazy Head - Pina Base - Hollywood

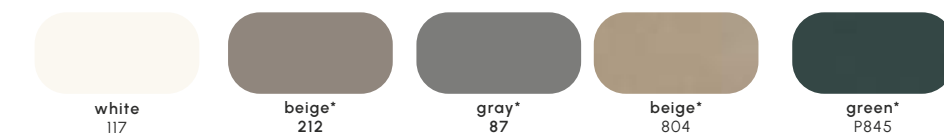

\*quantità minima ordinabile 6 pezzi  
\*minimum order quantity 6 pieces

## POLEASY® - FINITURA IL (illuminabile) POLEASY® - FINISHING IL (illuminated)

Agata - Agata Wood - Ampoule - Baraonda - Dublin - Joy - Light Tales - Nefos - Nova - Pandora - Pandora Lights and Pods - Penelope - Pina - Tulip - Vale - 2054



## POLEASY® - FINITURA VL (velluto) POLEASY® - FINISHING VL (velvet)

Baraonda - Chico - Dublin - Gem - Iris - Nova - Tao - Vale - Pina Base



\*quantità minima ordinabile 6 pezzi  
\*minimum order quantity 6 pieces

**MY YOUR**

via Nino Bixio 20,  
35010 Gazzo, Padova, Italy  
t +39 049 5963419  
f +39 049 5963335  
info@myyour.eu  
www.myyour.eu

Nella stampa su carta la qualità dei colori non può essere riprodotta fedelmente. MY YOUR si riserva la facoltà di apportare modifiche alle proprie collezioni in qualsiasi momento e senza preavviso.

Color shades can not be reproduced accurately on printed paper. MY YOUR is intitled to make modifications at any time and without notice.

